

DRB25-1087
mod. DRB24-1026

Design Review Board
June 12, 2025

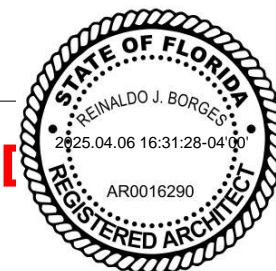

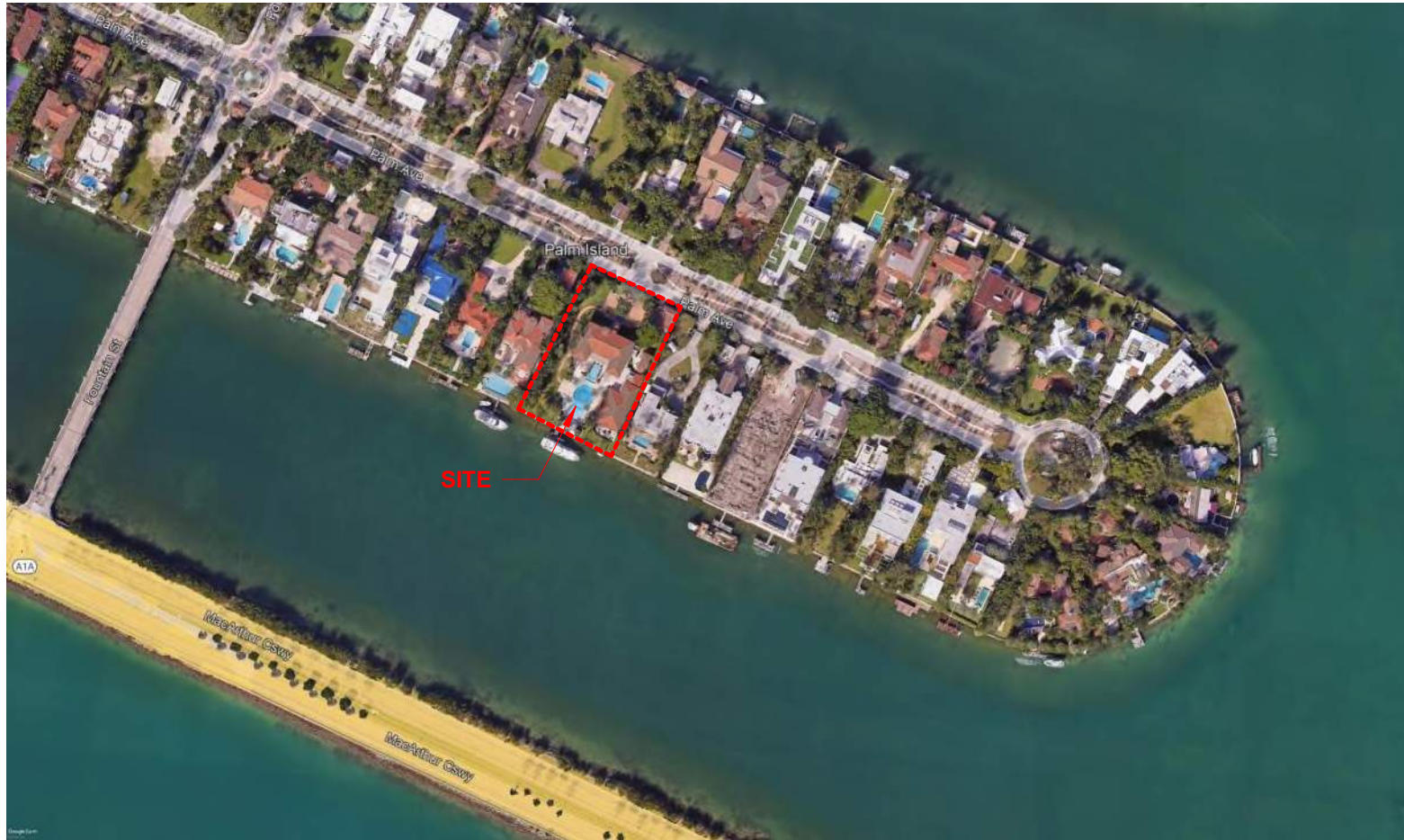

CONTEXT AERIAL
N.T.S.



CONTEXT SITE PLAN
N.T.S.



DESIGN REVIEW BOARD
City of Miami Beach, Florida

MEETING DATE: September 3, 2024

PROPERTY: **94 Palm Island** **02-4205-001-0330**

FILE NO: DRB24-1026

- Approval of two-story residence with an understory
- Variances
 - Reductions of front and side setbacks to retain an existing two-story structure
- Waivers
 - East side additional open space
 - Parking or vehicle storage within side yard

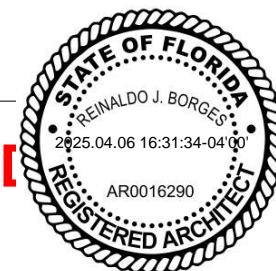

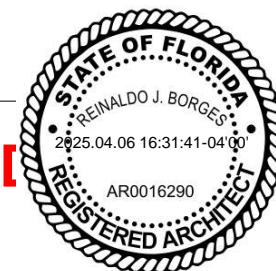

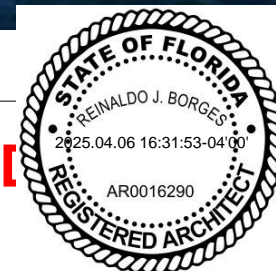

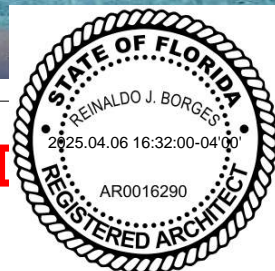
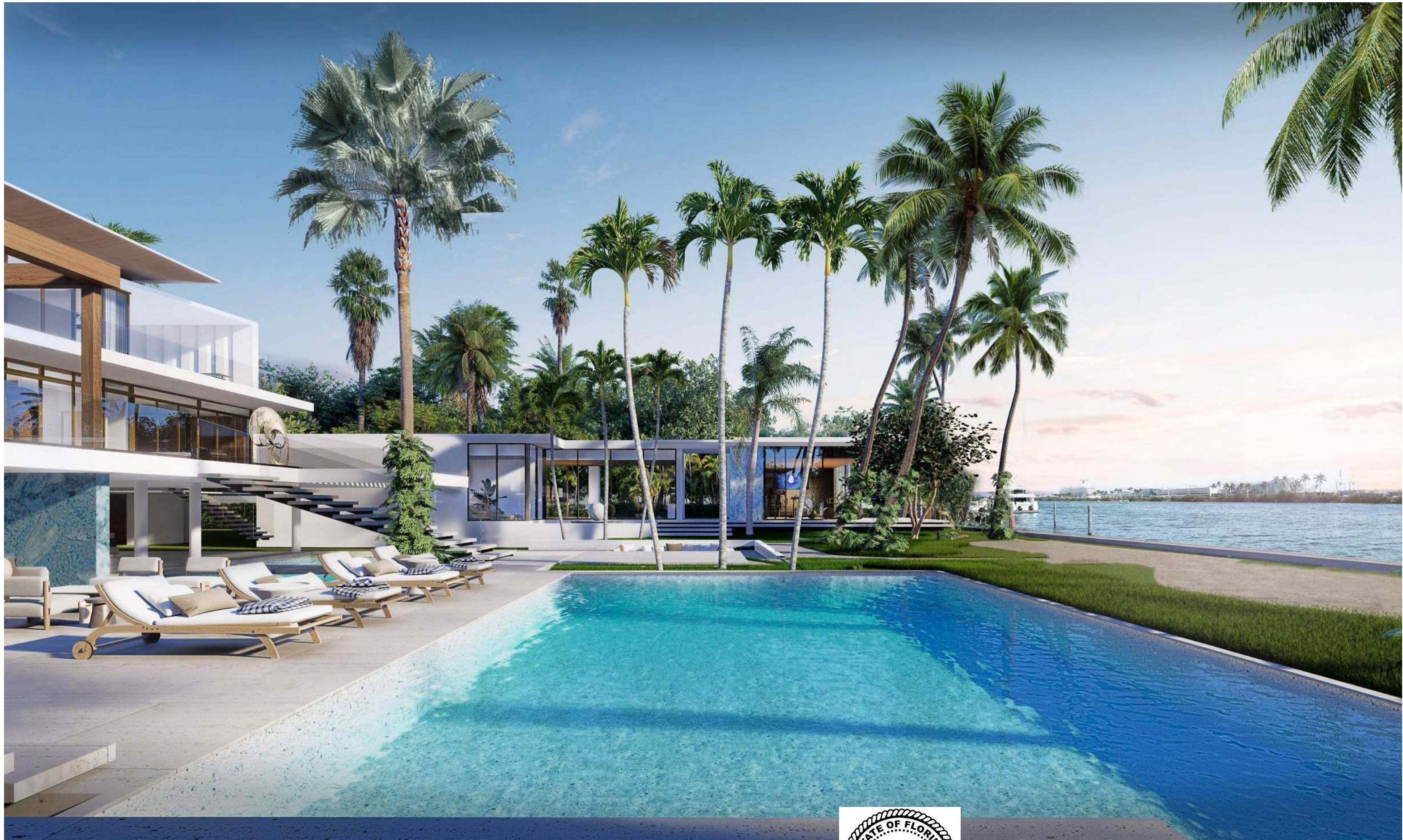

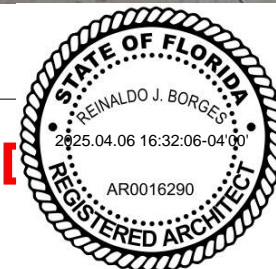

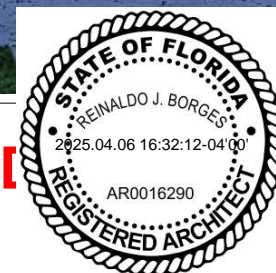
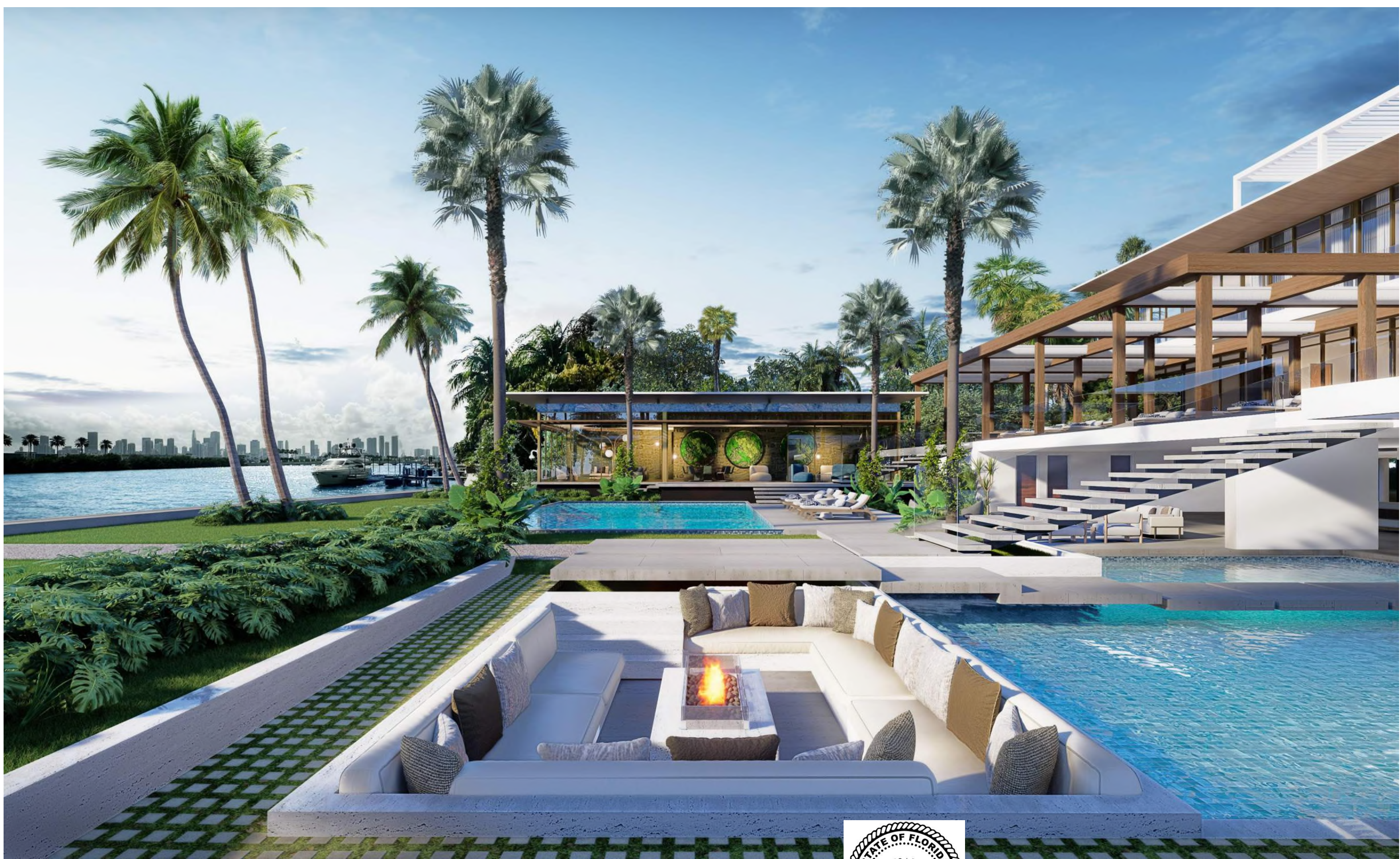

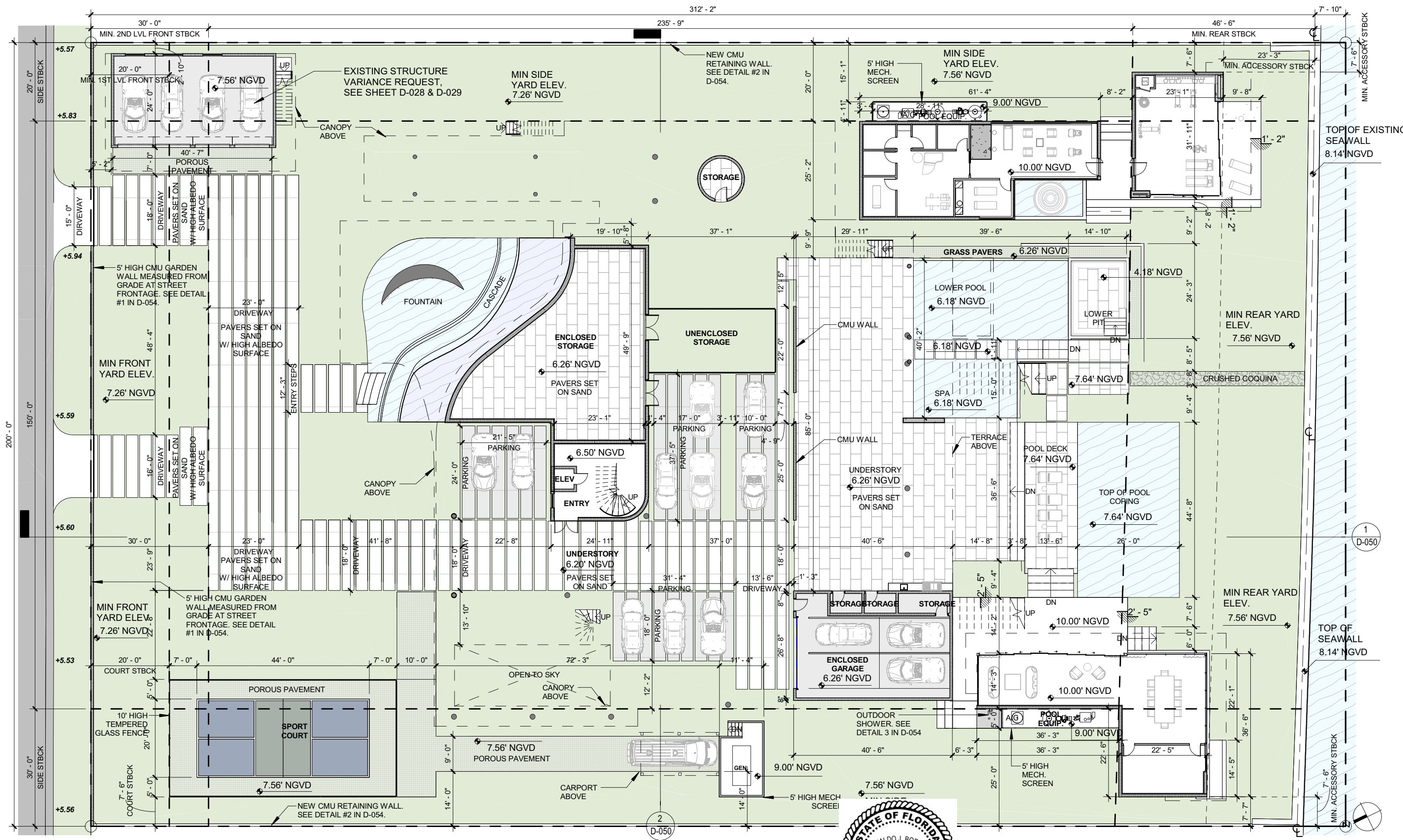

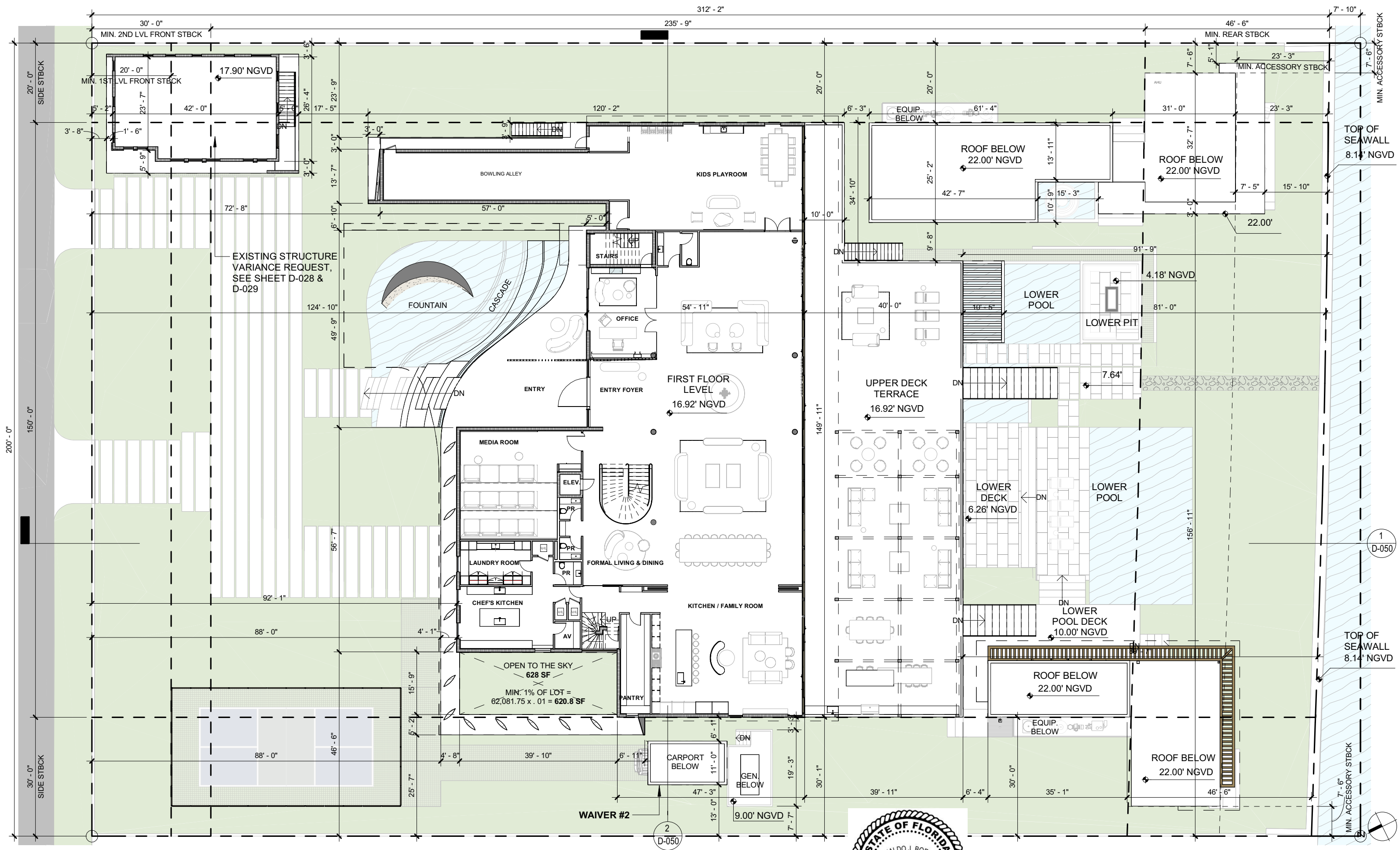

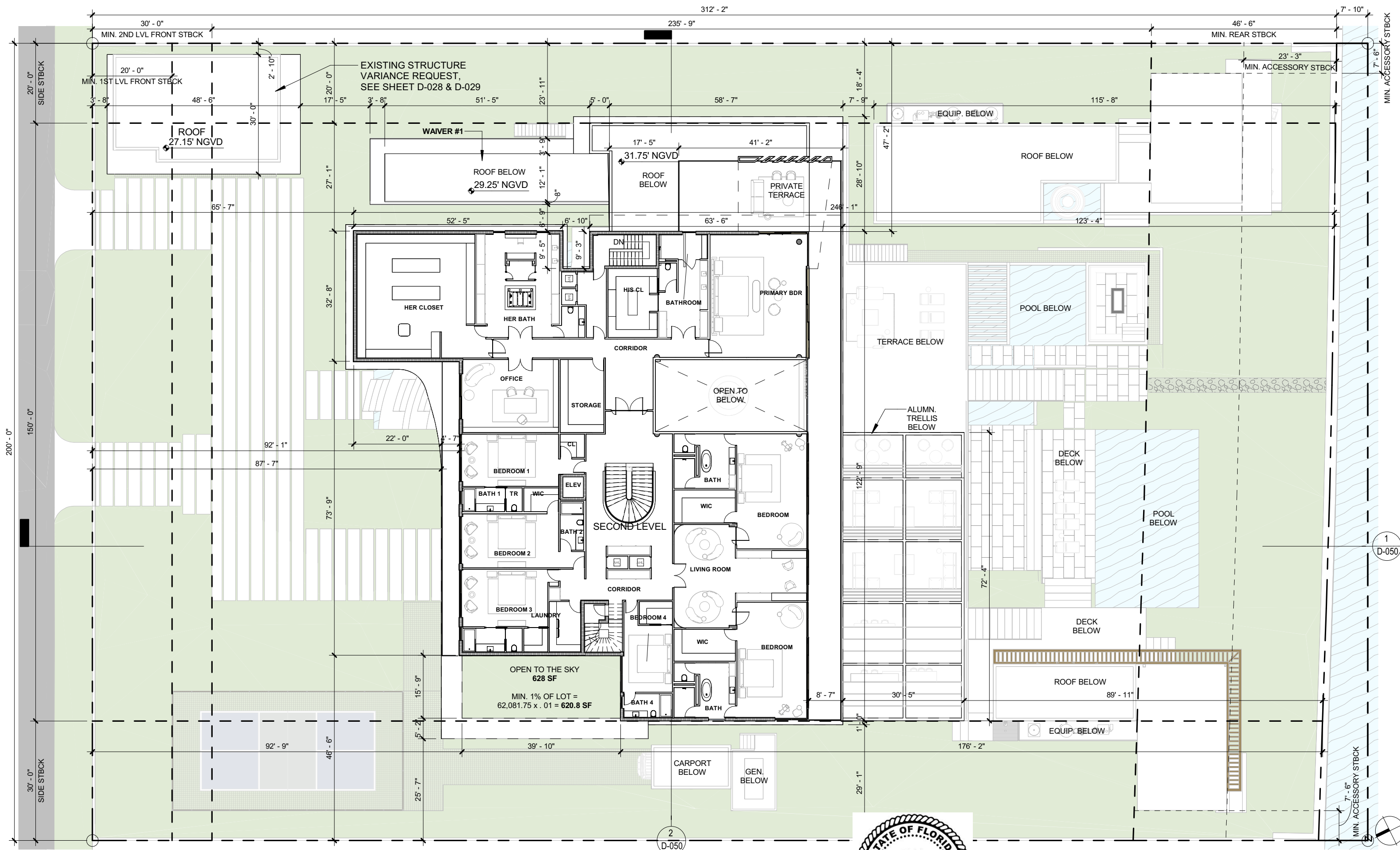

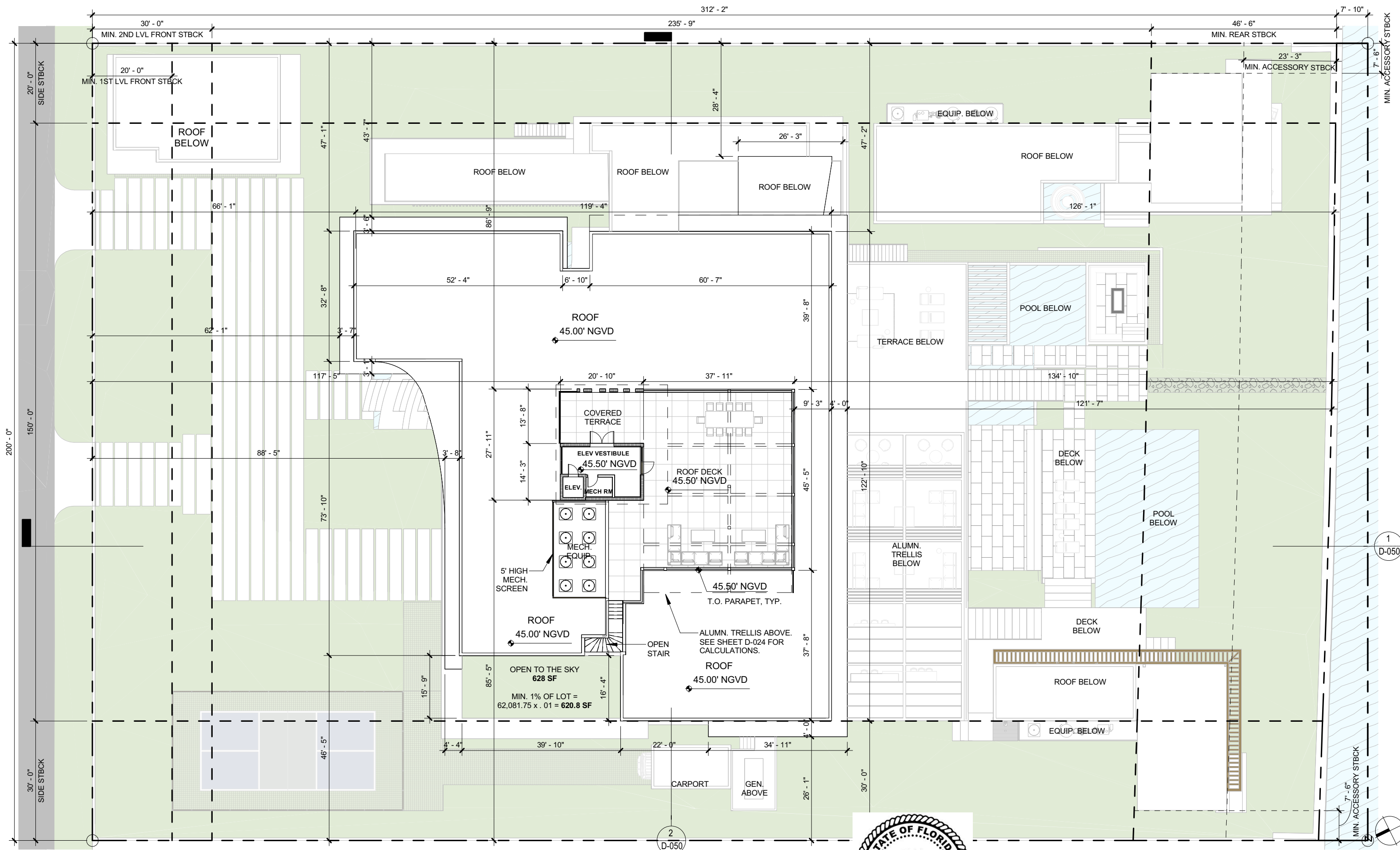

Variance Requests

1. Enclosed, air-conditioned storage areas within understory
2. Concrete within understory, limited to structural columns and pool areas
3. Exceed lot coverage by 4.15% to provide operable aluminum trellis
4. Exceed mechanical equipment and screening elements by 4'-5" and 5'-7" within interior side setback

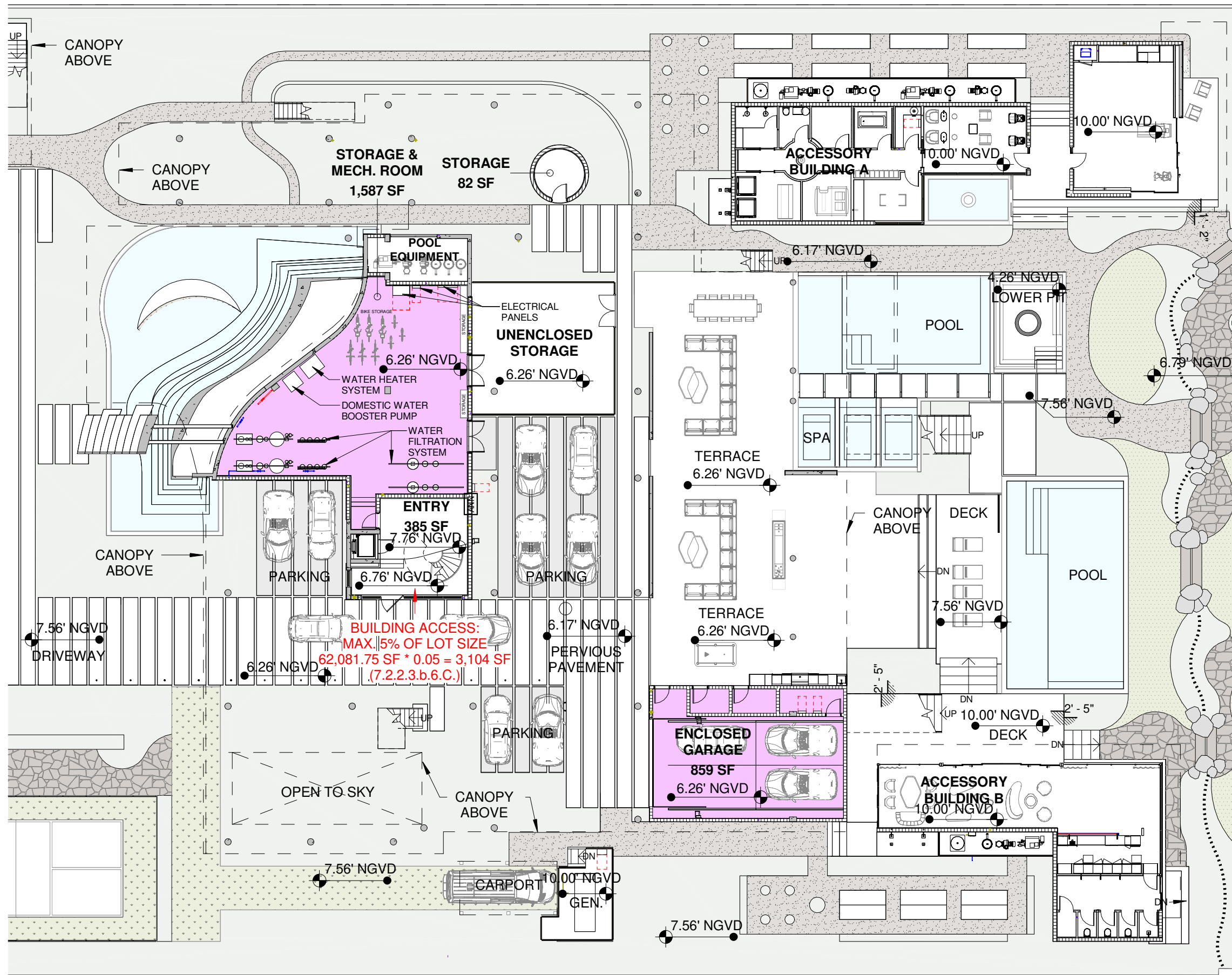

VARIANCE REQUEST 1:
Provide an enclosed, air-conditioned storage area within the understory.

LEGEND

PROPOSED AREA WITH CONC. SLAB

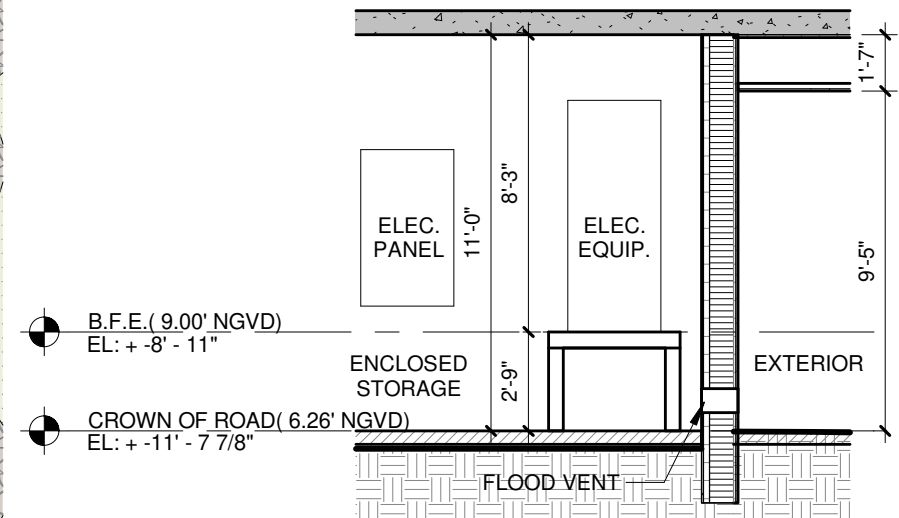

PER FBC-R322.1.6: ELECTRICAL SYSTEMS, EQUIPMNETS, AND COMPONENTS TO BE LOCATED AT OR ABOVE BFE.

2 EQUIPMENT LOCATION DIAGRAM

1 UNDERSTORY FLOOR PLAN DIAGRAM - VARIANCE 1

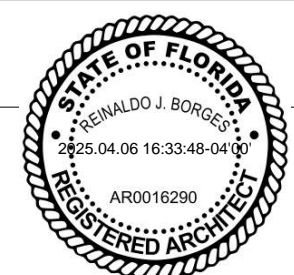

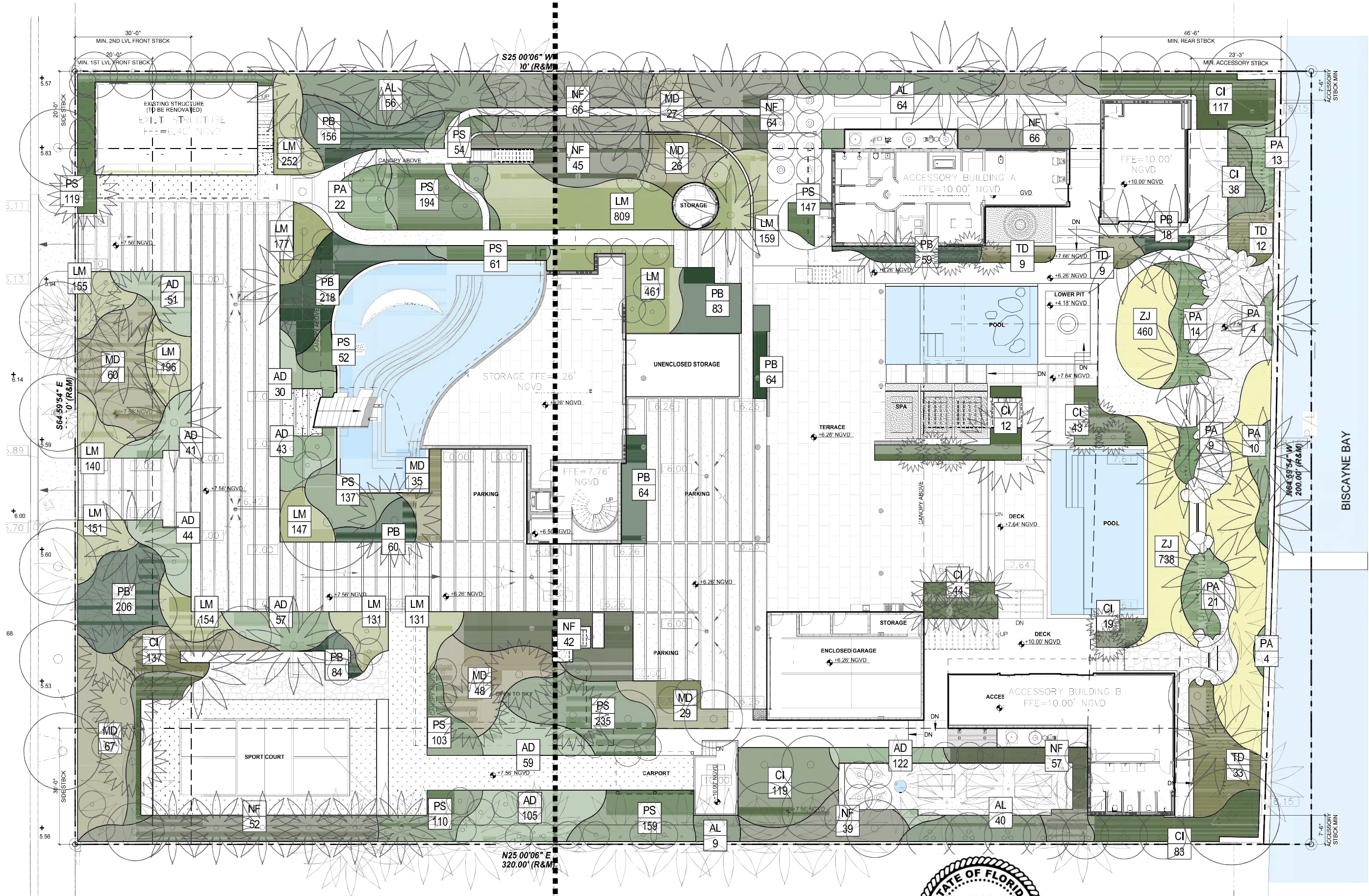

VARIANCE REQUEST 2:
 Provide concrete area within the understory for structural purposes surrounding support columns and pool areas

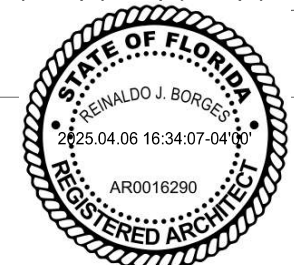

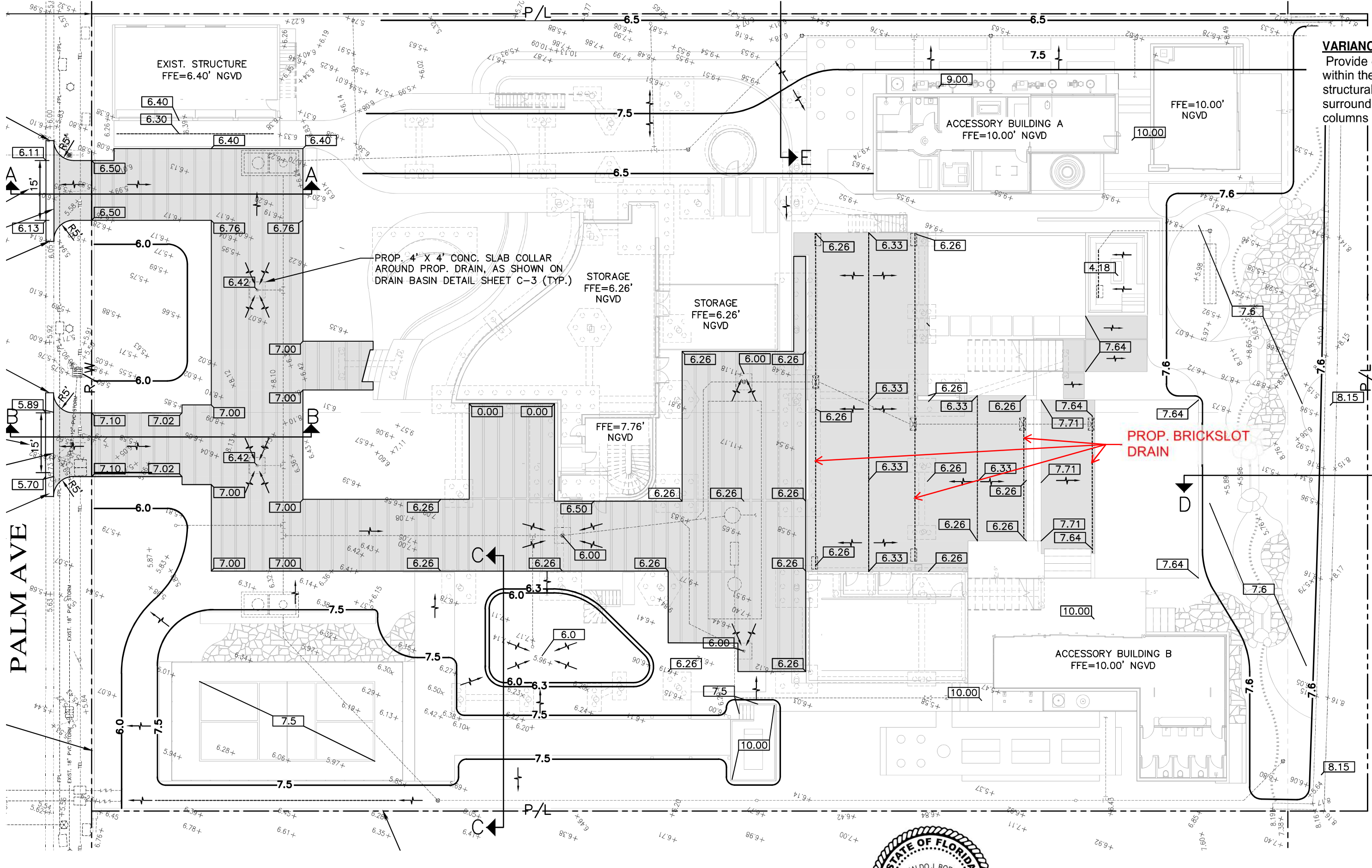

PALM AVE

BISCAYNE BAY
(P.B. 6, PG. 54)

VARIANCE REQUEST 2:
Provide concrete area within the understory for structural purposes surrounding support columns and pool areas

PROP. 4" X 4" CONC. SLAB COLLAR AROUND PROP. DRAIN, AS SHOWN ON DRAIN BASIN DETAIL SHEET C-3 (TYP.)

PROP. BRICKSLLOT DRAIN



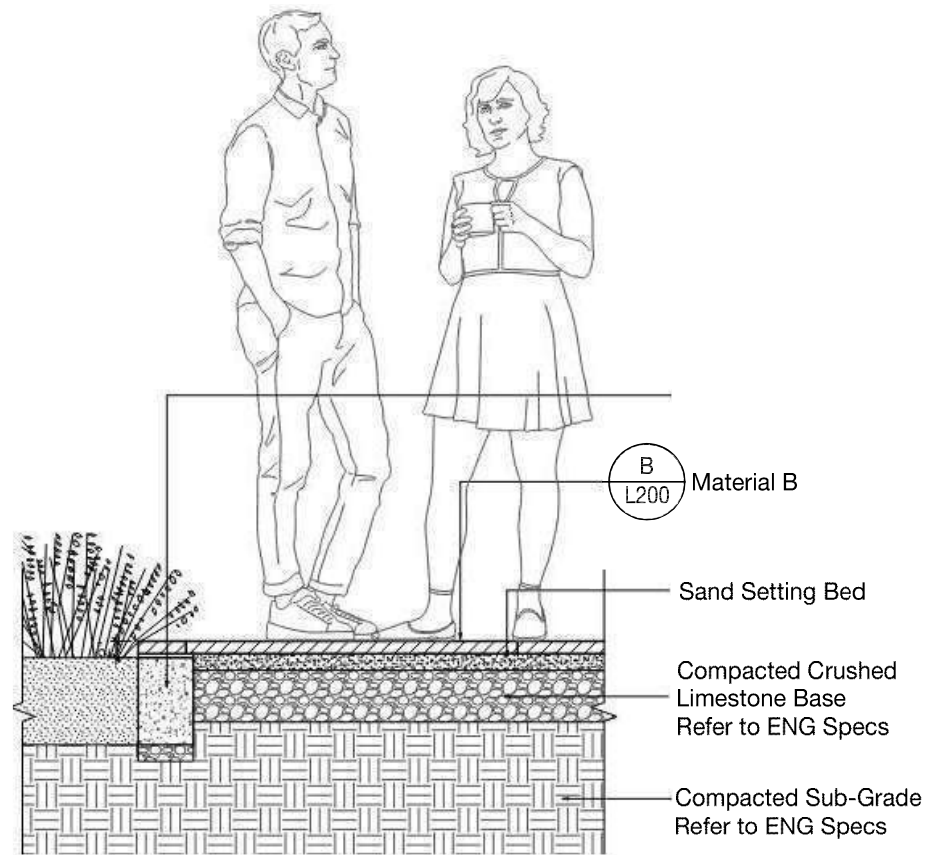

VARIANCE REQUEST 2:
 Provide concrete area within the understory for structural purposes surrounding support columns and pool areas

PAVER INSTALLATION DETAIL

SECTION



PAVER SETTLEMENT PHOTO

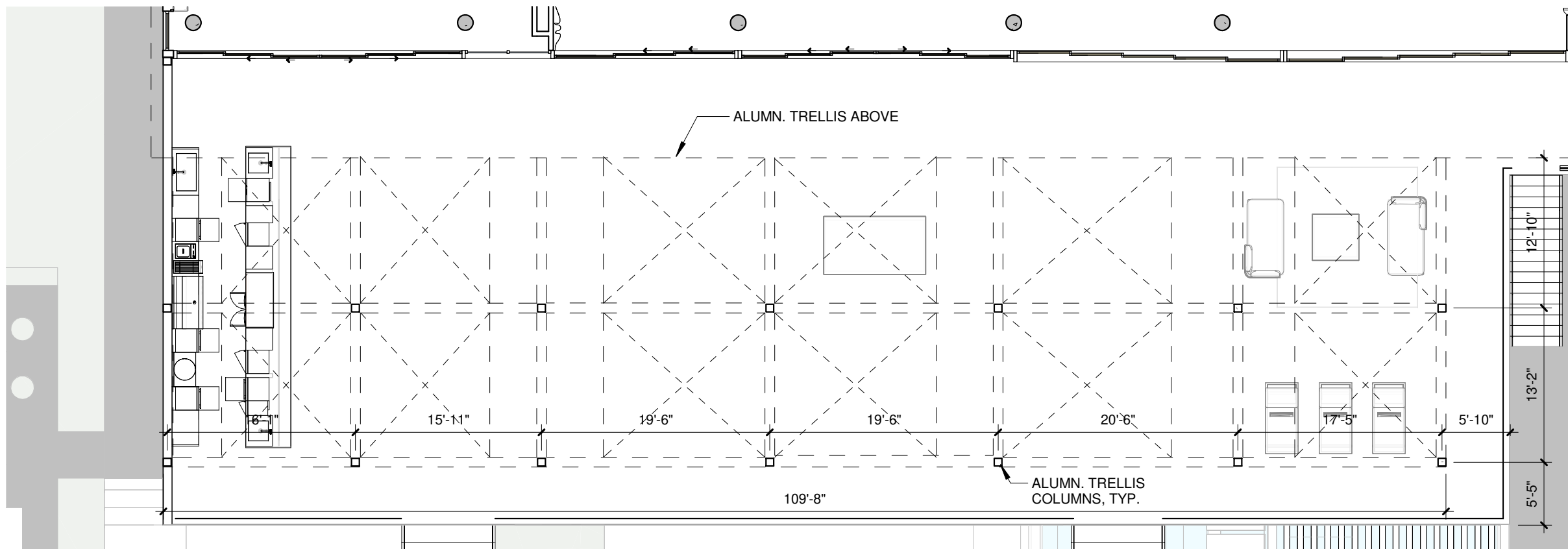

1 PERGOLA PLAN - FIRST LEVEL

VARIANCE REQUEST 3:
 Exceed the maximum permitted lot coverage by 4.15% to provide an operable aluminum trellis, rather than a trellis with fabric covering, that exceeds a projection of five (5) feet from the exterior wall.

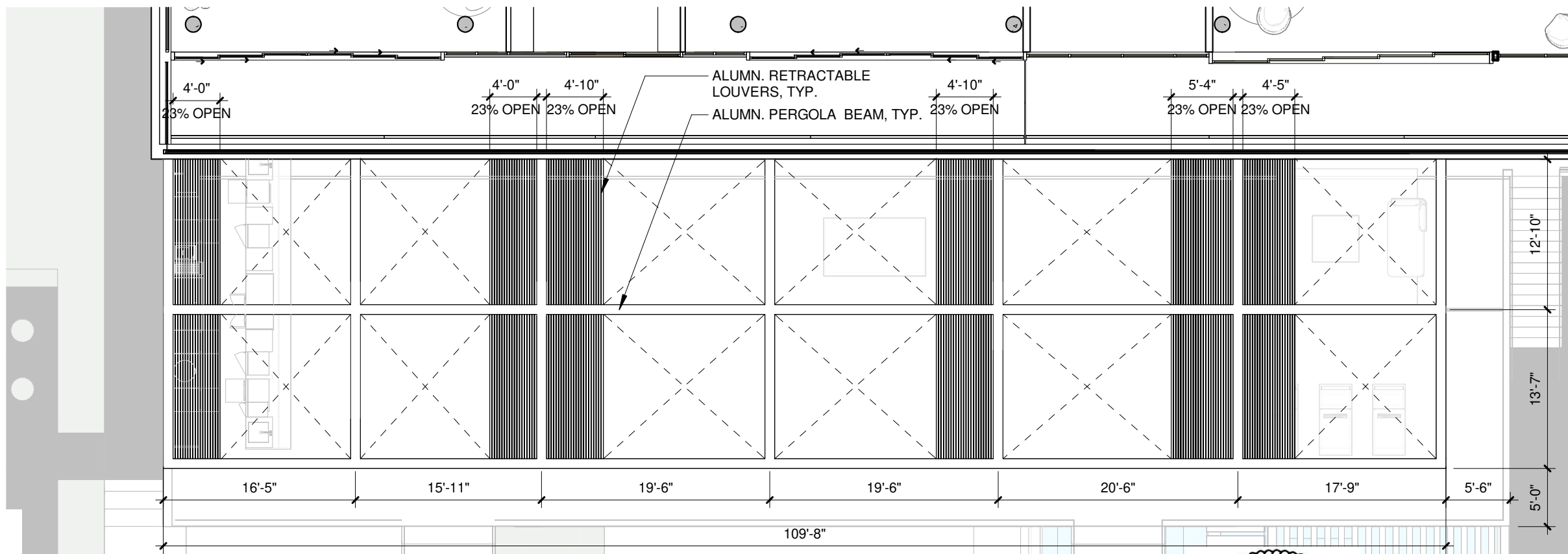

2 PERGOLA PLAN - SECOND LEVEL

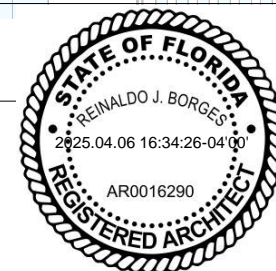



VARIANCE REQUEST 3:
Exceed the maximum permitted lot coverage by 4.15% to provide an operable aluminum trellis, rather than a trellis with fabric covering, that exceeds a projection of five (5) feet from the exterior wall.

VARIANCE REQUEST 3:
Exceed the maximum permitted lot coverage by 4.15% to provide an operable aluminum trellis, rather than a trellis with fabric covering, that exceeds a projection of five (5) feet from the exterior wall.



PERGOLA WITH ALUMN. LOUVERS

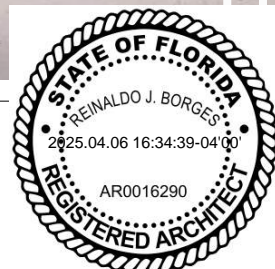

VARIANCE REQUEST 3:
Exceed the maximum permitted lot coverage by 4.15% to provide an operable aluminum trellis, rather than a trellis with fabric covering, that exceeds a projection of five (5) feet from the exterior wall.



PERGOLA WITH FABRIC ENCLOSURE

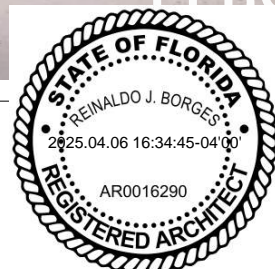

ALUMINIUM PERGOLA DETAILS

Fully Closed



Retracted

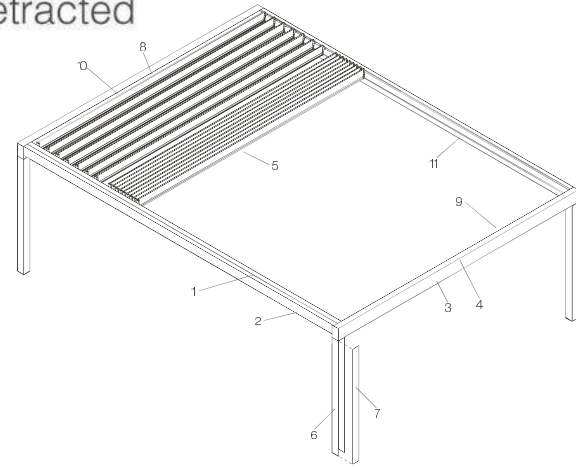

Side Elevation

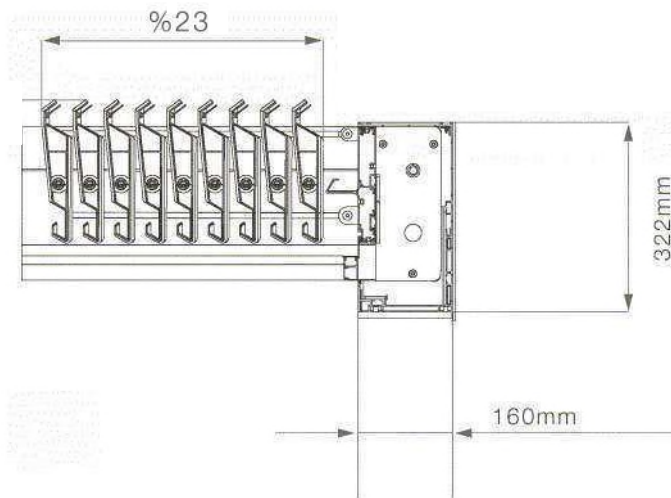

Retracted & Tilted



FABRIC PERGOLA DETAILS

Fully Closed



Retracted

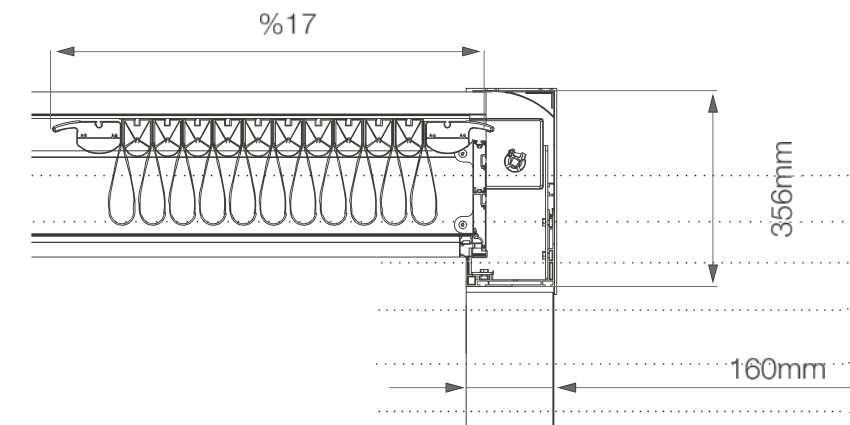
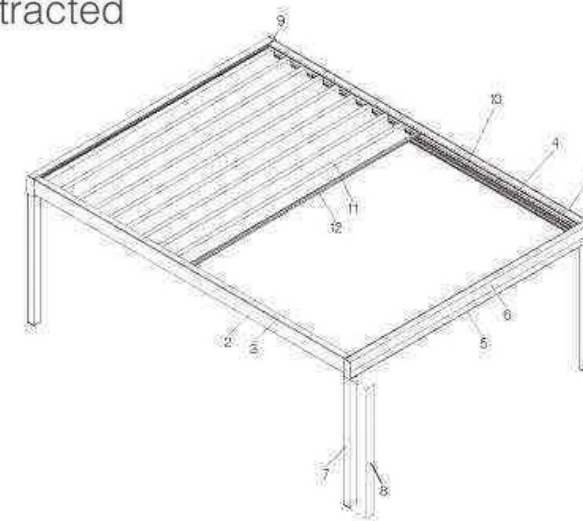

VARIANCE REQUEST 3:
Exceed the maximum permitted lot coverage by 4.15% to provide an operable aluminum trellis, rather than a trellis with fabric covering, that exceeds a projection of five (5) feet from the exterior wall.

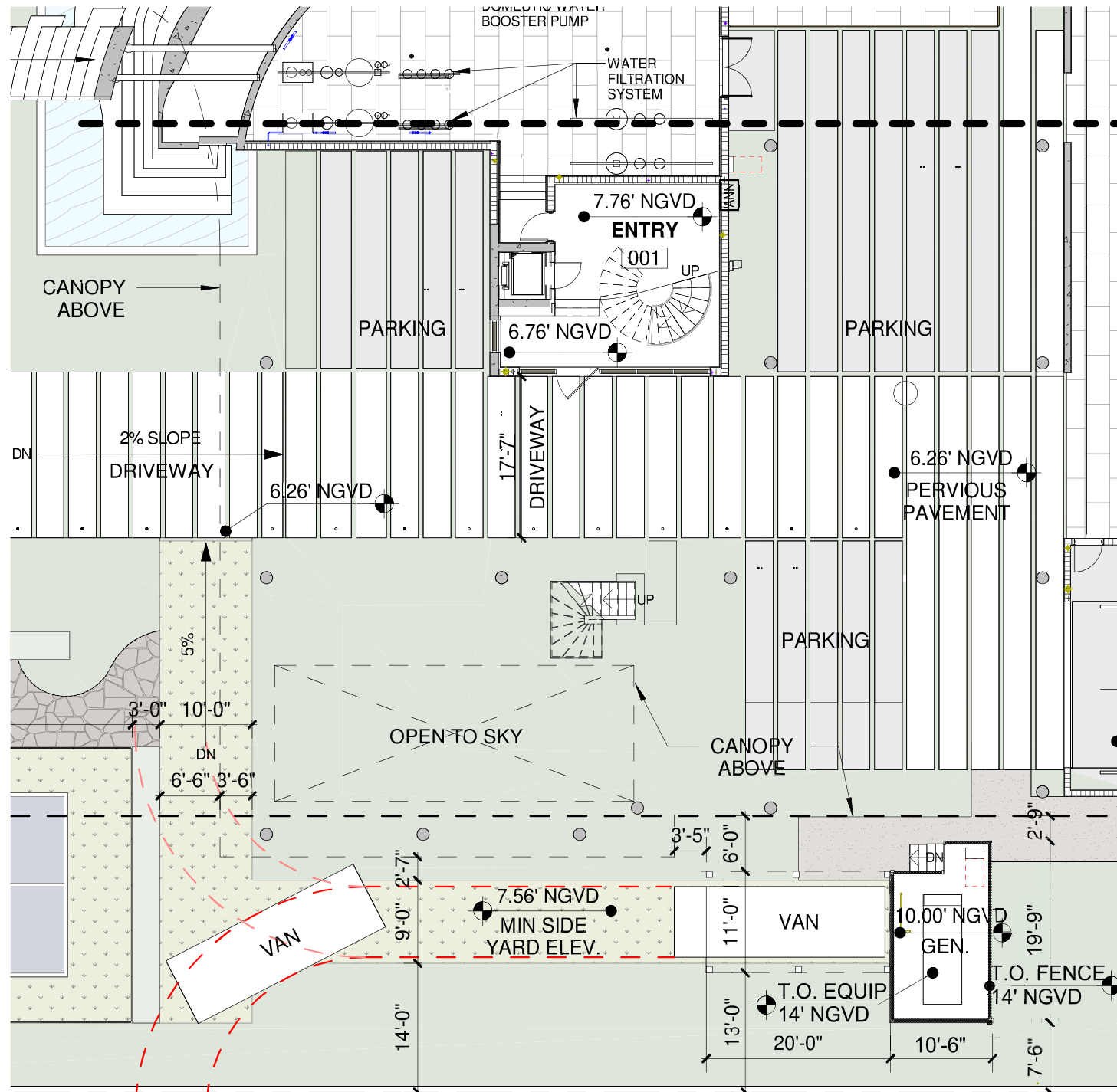

ORIGINAL DRB PLAN

MECHANICAL EQUIPMENT AND SCREENING ELEMENT TO BE PROVIDED AT A MAXIMUM ELEVATION OF 14' NGVD (B.F.E. 9' +5')

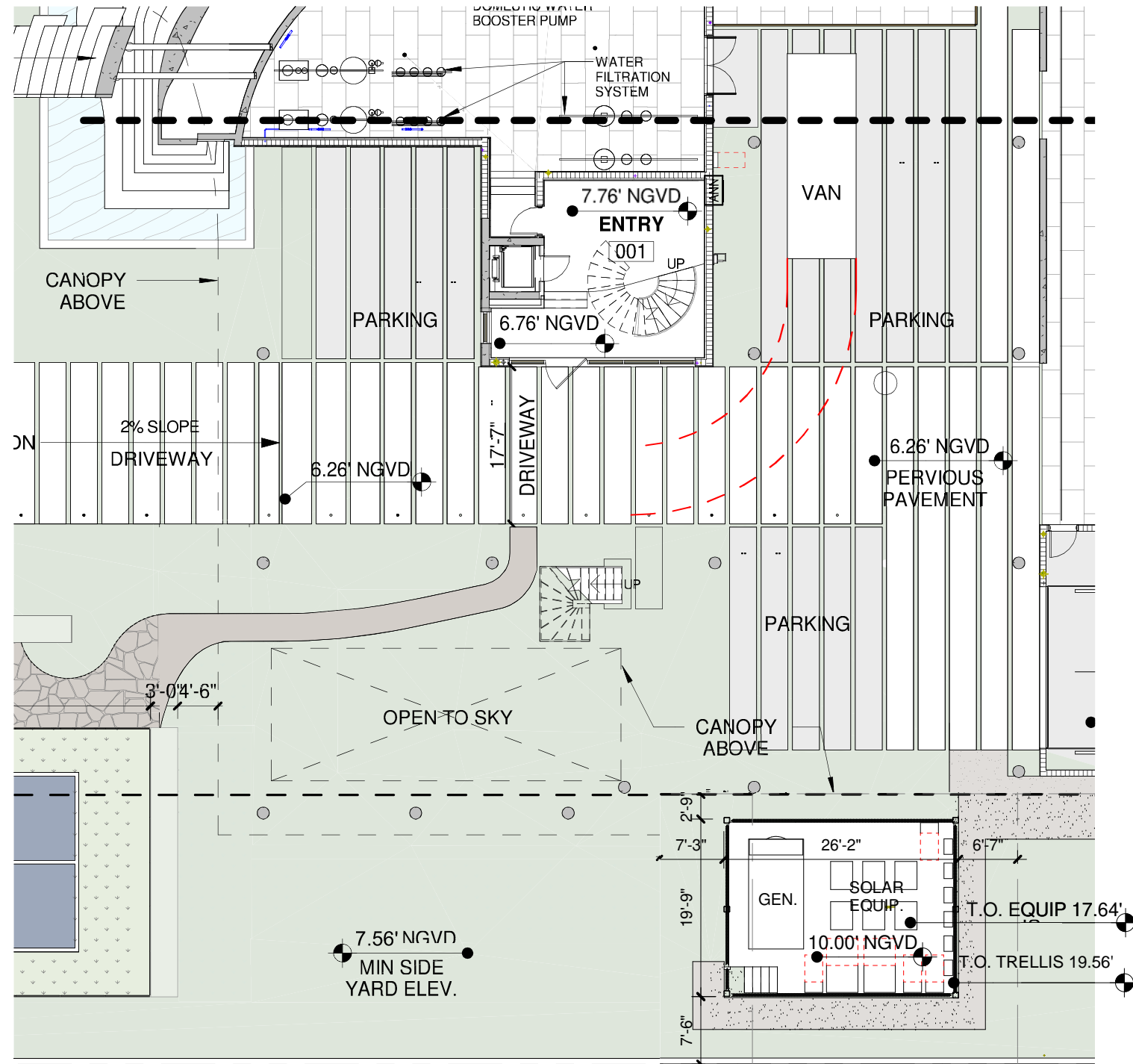

VARIANCE REQUEST

PROPOSED HEIGHT OF NEW MECHANICAL EQUIPMENT TO BE 17.64' NGVD
 PROPOSED HEIGHT OF SCREENING ELEMENT AND TRELLIS TO BE 19.56' NGVD



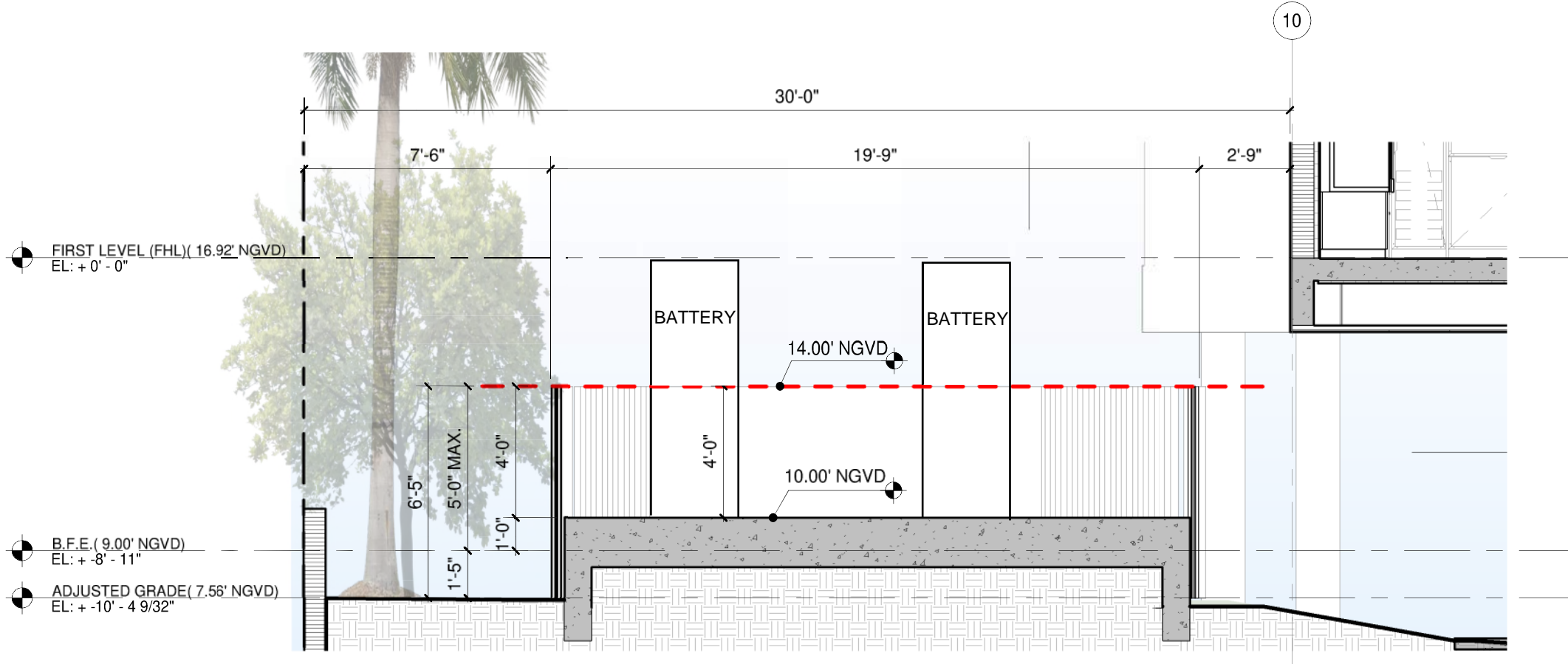

ORIGINAL DRB PLAN

MECHANICAL EQUIPMENT AND SCREENING ELEMENT TO BE PROVIDED AT A MAXIMUM ELEVATION OF 14' NGVD (B.F.E. 9' +5')

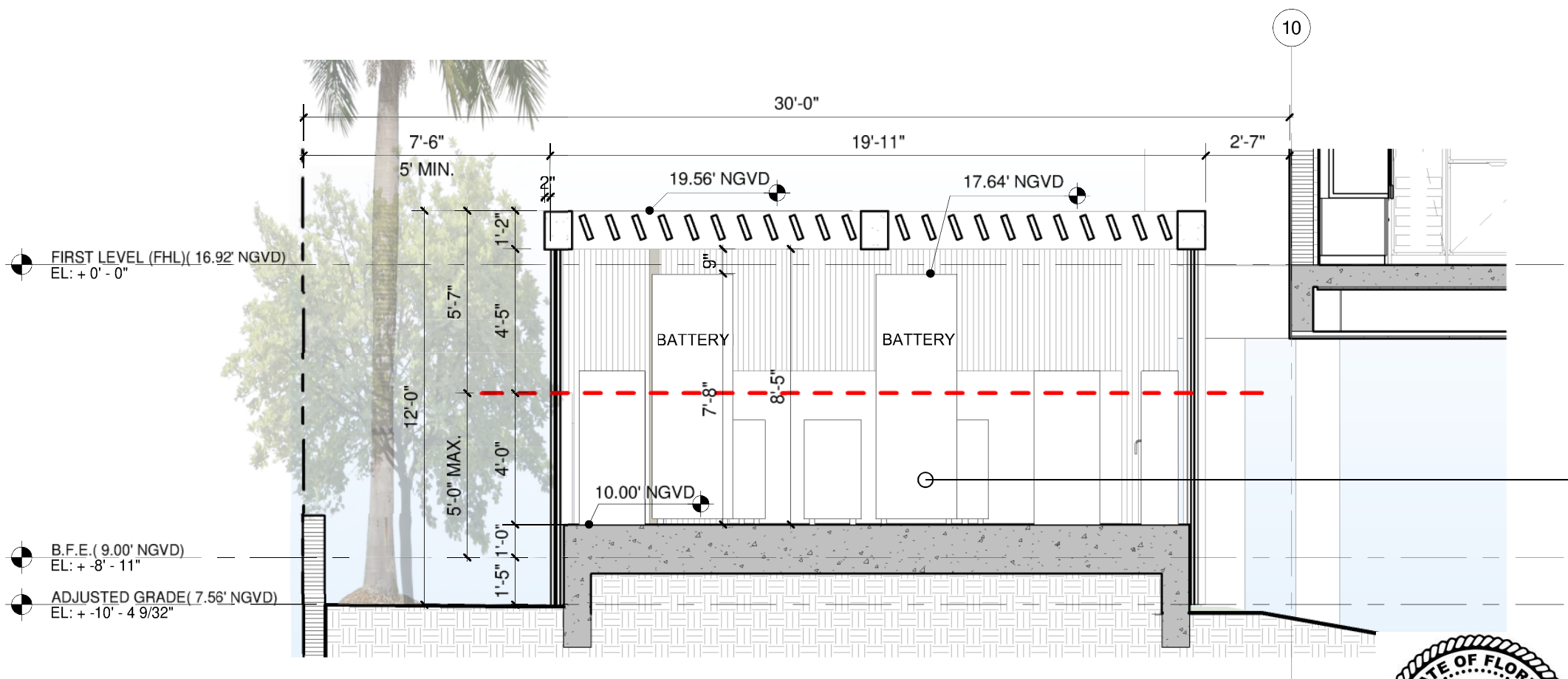

VARIANCE REQUEST

PROPOSED HEIGHT OF NEW MECHANICAL EQUIPMENT TO BE 17.64' NGVD
 PROPOSED HEIGHT OF SCREENING ELEMENT AND TRELLIS TO BE 19.56' NGVD



PROPOSED SOLAR PANEL BATTERY

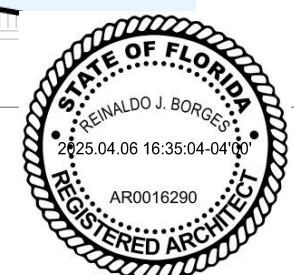



ORIGINAL DRB PLAN

MECHANICAL EQUIPMENT AND SCREENING ELEMENT TO BE PROVIDED AT A MAXIMUM ELEVATION OF 14' NGVD (B.F.E. 9' +5')

VARIANCE REQUEST

PROPOSED HEIGHT OF NEW MECHANICAL EQUIPMENT TO BE 17.64' NGVD
 PROPOSED HEIGHT OF SCREENING ELEMENT AND TRELLIS TO BE 19.56' NGVD

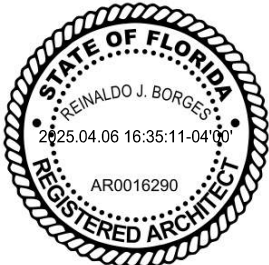



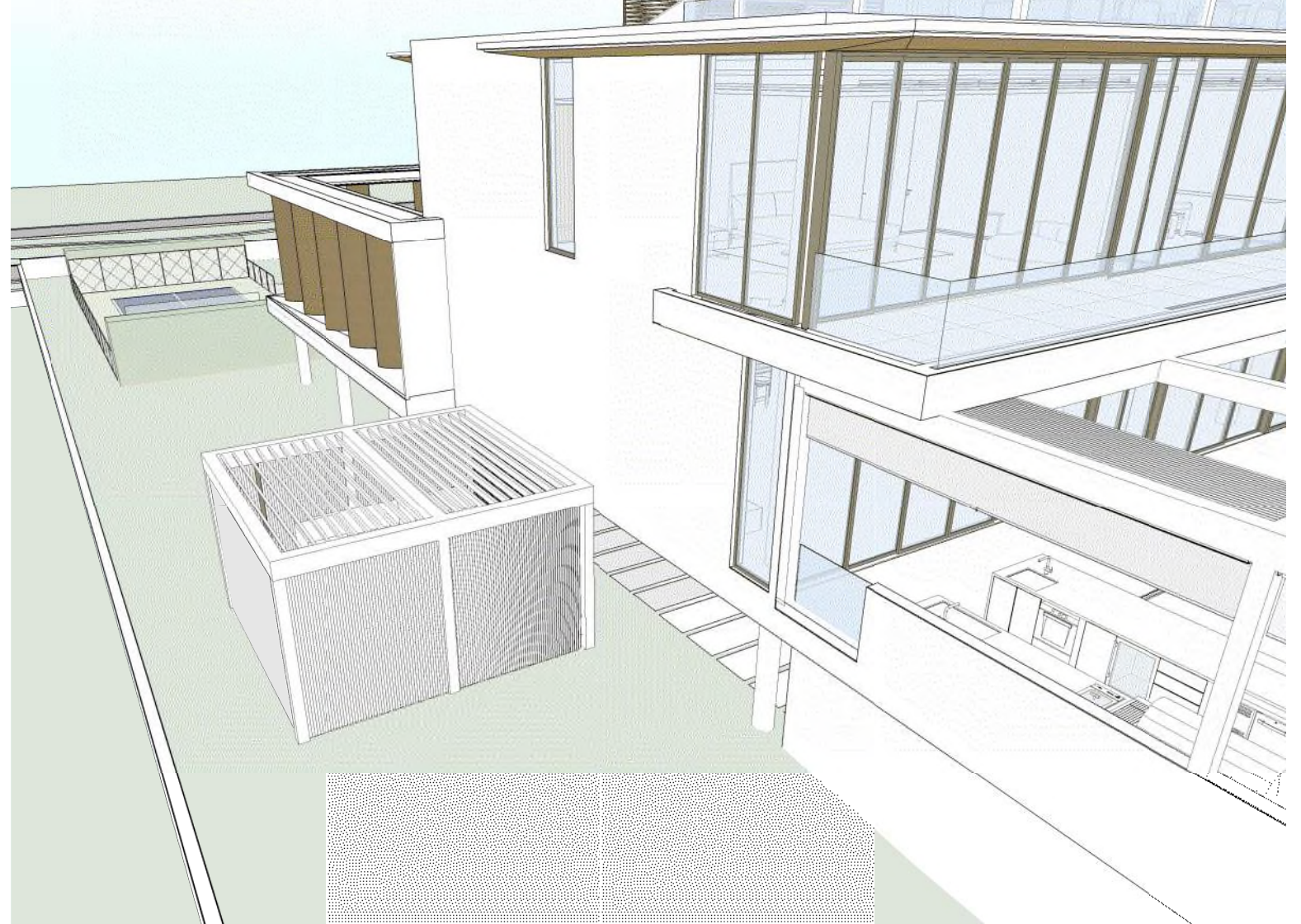

ORIGINAL DRB PLAN

MECHANICAL EQUIPMENT AND SCREENING ELEMENT TO BE PROVIDED AT A MAXIMUM ELEVATION OF 14' NGVD (B.F.E. 9' +5')

VARIANCE REQUEST

PROPOSED HEIGHT OF NEW MECHANICAL EQUIPMENT TO BE 17.64' NGVD
 PROPOSED HEIGHT OF SCREENING ELEMENT AND TRELLIS TO BE 19.56' NGVD

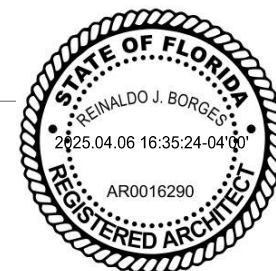

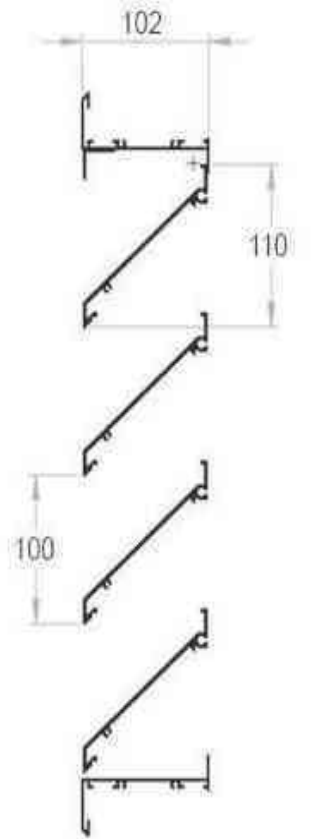
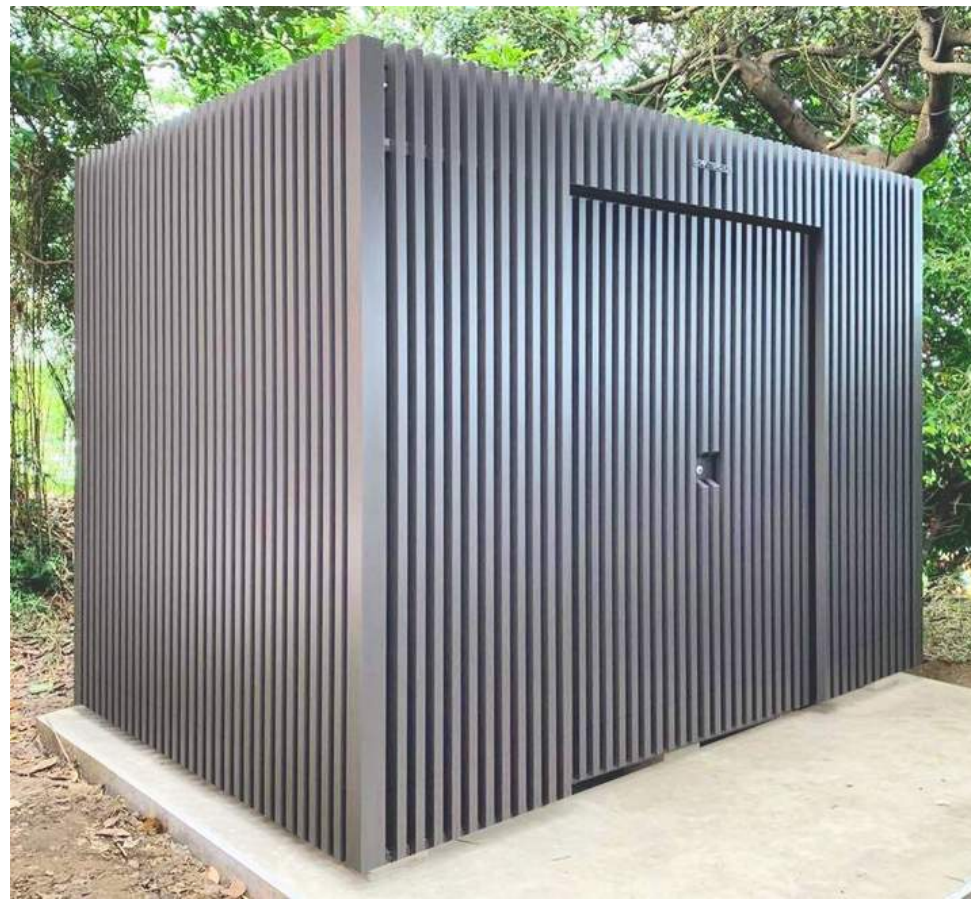



PS-01

PAINTED SMOOTH
STUCCO FINISH

VP-01

VENETIAN PLASTER FINISH

MT-01

METAL COLUMN COVER, BRUSHED
BRONZE ALUMINIUM FINISH

ST-01

EXTERIOR TILE CLADDING
LARGE FORMAT

ST-02

EXTERIOR STONE CLADDING
LARGE FORMAT

ST-03

EXTERIOR TILE CLADDING SMALL
FORMAT.

WD-01

CLADDEN IN SOLID HARDWOOD



PD-01

PIVOT ALUMINIUM DOOR
CLADDEN IN HARDWOOD

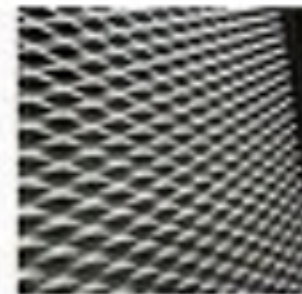

MS-01

ALUMINIUM MECHANICAL
SCREEN



GL-01

IMPACT GLAZING - CLEAR W/
BRONZE FRAME



GLR

IMPACT GLASS HANDRAIL - CLEAR



PS-01 WT GL-01

GLR GL-01

PS-01

ST-03

ST-02

1
D-050

GLR WD-01 GL-01

GL-01 GLR

UPPER ROOF(55.00' NGVD)
EL: + 38' - 1"

ROOF LEVEL(45.00' NGVD)
EL: + 28' - 1"

SECOND LEVEL(31.75' NGVD)
EL: + 14' - 10"

ACCESSORY ROOF(22.00' NGVD)
EL: + 5' - 1"

FIRST LEVEL (FHL)(10.92' NGVD)
EL: + 0' - 0"

DFE (BFE + 5)(14.00' NGVD)
EL: + -2' - 11"

ACCESSORY ENTRANCE(10.00' NGVD)
EL: + -6' - 11"

B.F.E.(9.00' NGVD)
EL: + -7' - 11"

ADJUSTED GRADE(7.56' NGVD)
EL: + -9' - 4 9/32"

10'-0"
13'-3"
14'-10"
31'-0" MAX. HEIGHT



PS-01
PAINTED SMOOTH
STUCCO FINISH



ST-01
EXTERIOR TILE CLADDING LARGE
FORMAT



ST-02
EXTERIOR STONE CLADDING
LARGE FORMAT



ST-03
EXTERIOR TILE CLADDING SMALL
FORMAT.



WD-01
CLADDEN IN SOLID HARDWOOD



GL-01
IMPACT GLAZING - CLEAR W/
BRONZE FRAME



GLR
IMPACT GLASS HANDRAIL - CLEAR



WT
ALUMINIUM TRELLIS
CLADDEN IN WOOD



UPPER ROOF (55.00' NGVD)
EL: + 38' - 1"

ROOF LEVEL (45.00' NGVD)
EL: + 28' - 1"

SECOND LEVEL (31.75' NGVD)
EL: + 14' - 10"

ACCESSORY ROOF (22.00' NGVD)
FIRST LEVEL (FHL) (16.32' NGVD)
EL: + 0' - 0"

DFE (BFE + 5) (14.00' NGVD)
EL: + -2' - 11"

ACCESSORY ENTRANCE (10.00' NGVD)
EL: + -6' - 11"

B.F.E. (9.00' NGVD)
EL: + -7' - 11"

ADJUSTED GRADE (7.56' NGVD)
EL: + -9' - 4 9/32"

PS-01 GL-01 PS-01 MS-01 PS-01 ST-03 PS-01 ST-03



PS-01
PAINTED SMOOTH STUCCO FINISH

VP-01
VENETIAN PLASTER FINISH

ST-01
EXTERIOR TILE CLADDING LARGE FORMAT

ST-02
EXTERIOR STONE CLADDING LARGE FORMAT

ST-03
EXTERIOR TILE CLADDING SMALL FORMAT.

WD-01
CLADDED IN SOLID HARDWOOD



MS-01
ALUMINIUM MECHANICAL SCREEN

GL-01
IMPACT GLAZING - CLEAR W/ BRONZE FRAME

GLR
IMPACT GLASS HANDRAIL - CLEAR



UPPER ROOF(55.00' NGVD)
EL: + 38' - 1"

ROOF LEVEL(45.00' NGVD)
EL: + 28' - 1"

SECOND LEVEL(31.75' NGVD)
EL: + 14' - 10"

FIRST LEVEL (FHL)(16.92' NGVD)
EL: + 0' - 0"

DFE (BFE + 5)(14.00' NGVD)
EL: + -2' - 11"

ACCESSORY ENTRANCE(10.00' NGVD)
EL: + -6' - 11"

B.F.E.(9.00' NGVD)
EL: + -7' - 11"

ADJUSTED GRADE(7.56' NGVD)
EL: + -9' - 4 9/32"

MT-01 ST-02 ST-03 GL-01 PS-01 GL-01 PS-01 PS-01 MS-01 PS-01



PS-01
PAINTED SMOOTH
STUCCO FINISH



MT-01
METAL COLUMN COVER, BRUSHED
BRONZE ALUMINIUM FINISH



ST-01
EXTERIOR TILE CLADDING LARGE
FORMAT



ST-02
EXTERIOR STONE CLADDING
LARGE FORMAT



ST-03
EXTERIOR TILE CLADDING SMALL
FORMAT.



WD-01
CLADDEN IN SOLID HARDWOOD

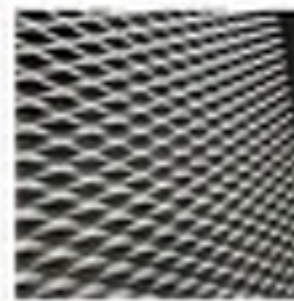

MS-01
ALUMINIUM MECHANICAL
SCREEN



MS-02
METAL SCREEN



GL-01
IMPACT GLAZING - CLEAR W/
BRONZE FRAME



GLR
IMPACT GLASS HANDRAIL - CLEAR

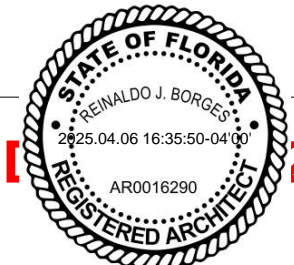



1 NORTH ELEVATION
1/16" = 1'-0"

PS-01 PAINTED SMOOTH STUCCO FINISH	VP-01 VENETIAN PLASTER FINISH	MT-01 METAL COLUMN COVER, BRUSHED BRONZE ALUMINIUM FINISH	ST-01 EXTERIOR TILE CLADDING LARGE FORMAT	ST-02 EXTERIOR STONE CLADDING LARGE FORMAT	ST-03 EXTERIOR TILE CLADDING SMALL FORMAT.	WD-01 CLADDEN IN SOLID HARDWOOD
PD-01 PIVOT ALUMINIUM DOOR CLADDEN IN HARDWOOD	MS-01 ALUMINIUM MECHANICAL SCREEN	GL-01 IMPACT GLAZING - CLEAR W/ BRONZE FRAME	GLR IMPACT GLASS HANDRAIL - CLEAR			

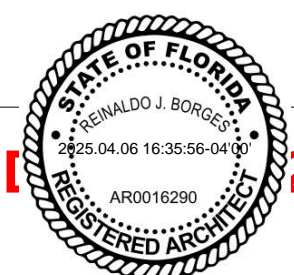

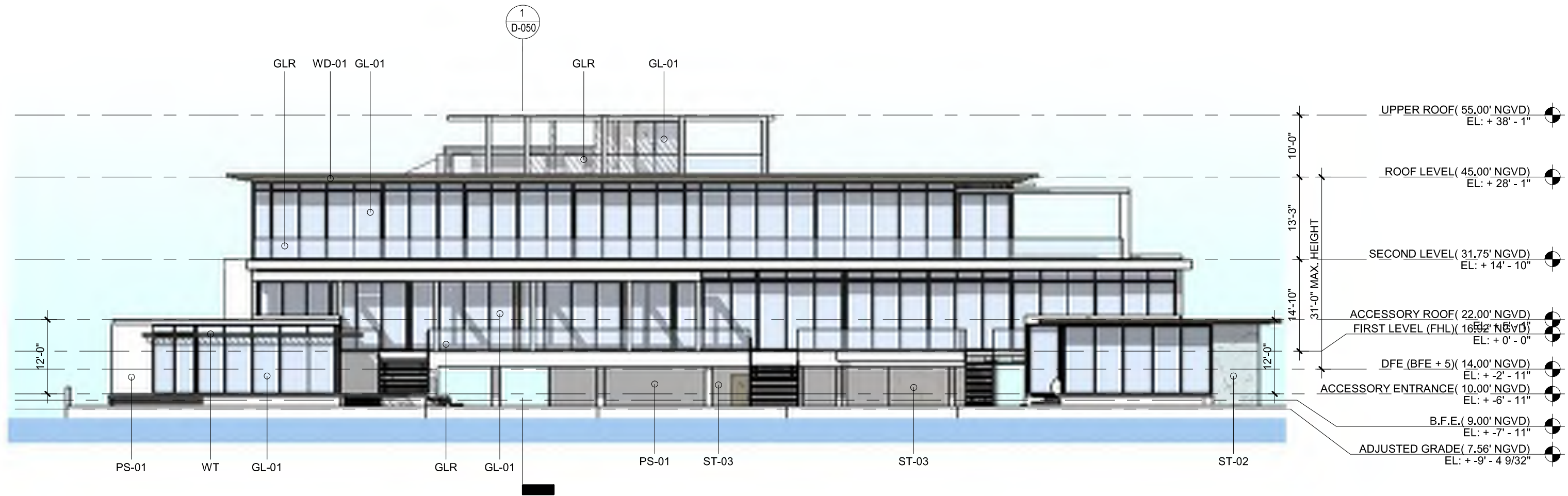

1 SOUTH ELEVATION
1/16" = 1'-0"



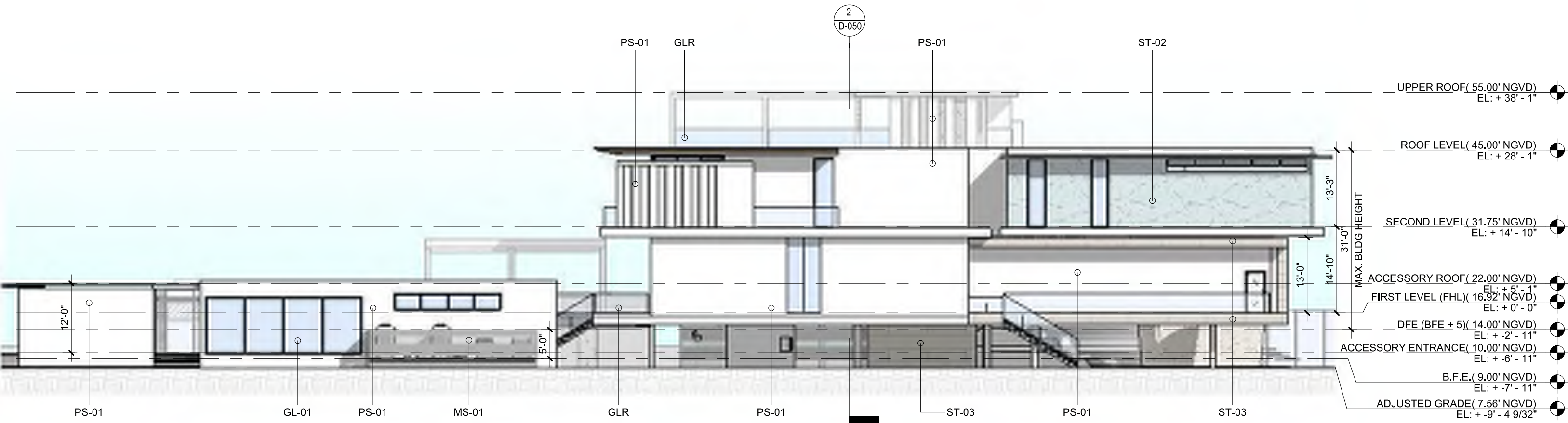

1 EAST ELEVATION
1/16" = 1'-0"



PS-01
PAINTED SMOOTH
STUCCO FINISH

VP-01
VENETIAN PLASTER FINISH

ST-01
EXTERIOR TILE CLADDING LARGE
FORMAT

ST-02
EXTERIOR STONE CLADDING
LARGE FORMAT

ST-03
EXTERIOR TILE CLADDING SMALL
FORMAT.

WD-01
CLADDEN IN SOLID HARDWOOD

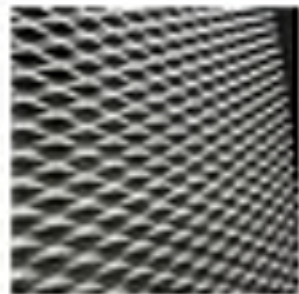

MS-01
ALUMINIUM MECHANICAL
SCREEN



GL-01
IMPACT GLAZING - CLEAR W/
BRONZE FRAME



GLR
IMPACT GLASS HANDRAIL - CLEAR

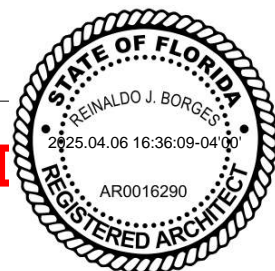

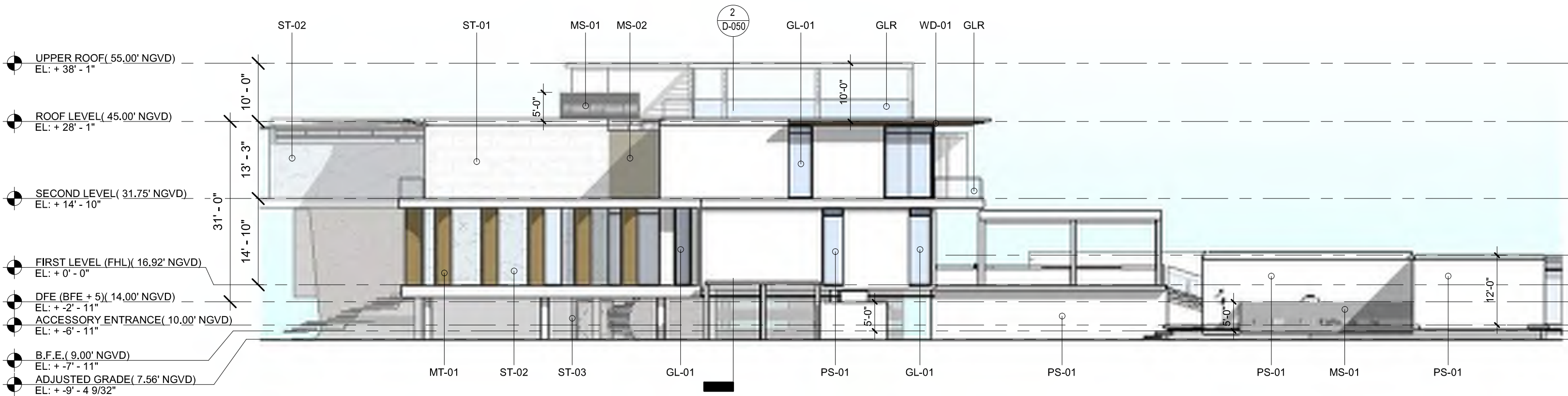

1 WEST ELEVATION
1/16" = 1'-0"



- PS-01**
PAINTED SMOOTH STUCCO FINISH
- MT-01**
METAL COLUMN COVER, BRUSHED BRONZE ALUMINIUM FINISH
- ST-01**
EXTERIOR TILE CLADDING LARGE FORMAT
- ST-02**
EXTERIOR STONE CLADDING LARGE FORMAT
- ST-03**
EXTERIOR TILE CLADDING SMALL FORMAT.
- WD-01**
CLADDED IN SOLID HARDWOOD
- MS-01**
ALUMINIUM MECHANICAL SCREEN
- MS-02**
METAL SCREEN
- GL-01**
IMPACT GLAZING - CLEAR W/ BRONZE FRAME



GLR
IMPACT GLASS HANDRAIL - CLEAR

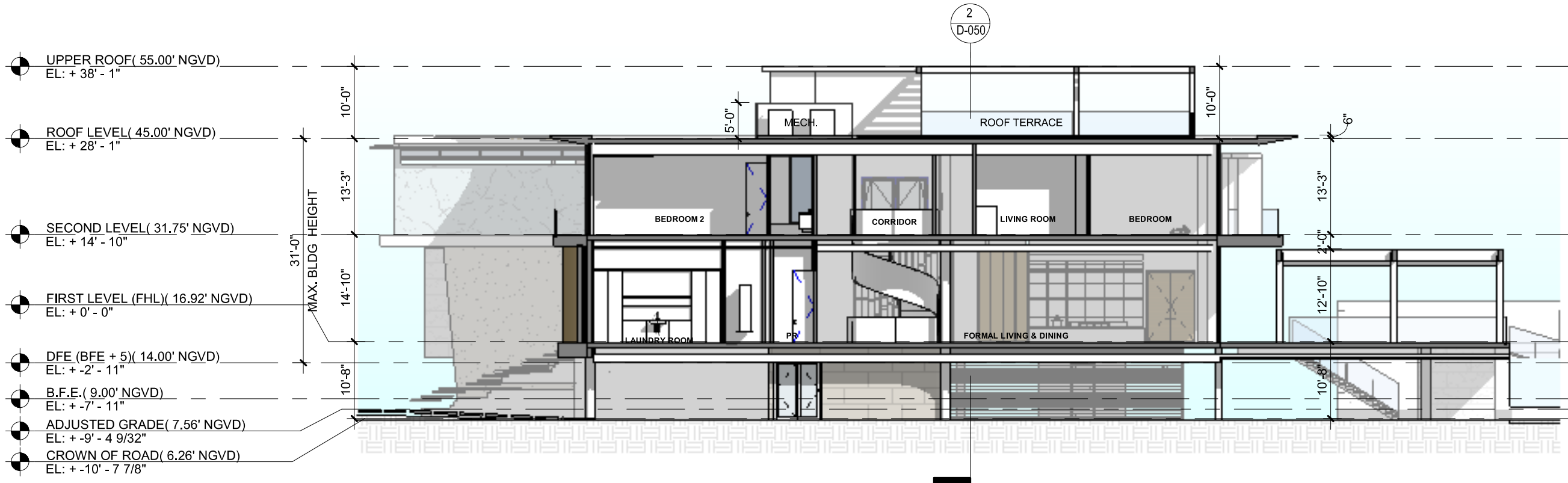

1 Section 2
1/16" = 1'-0"

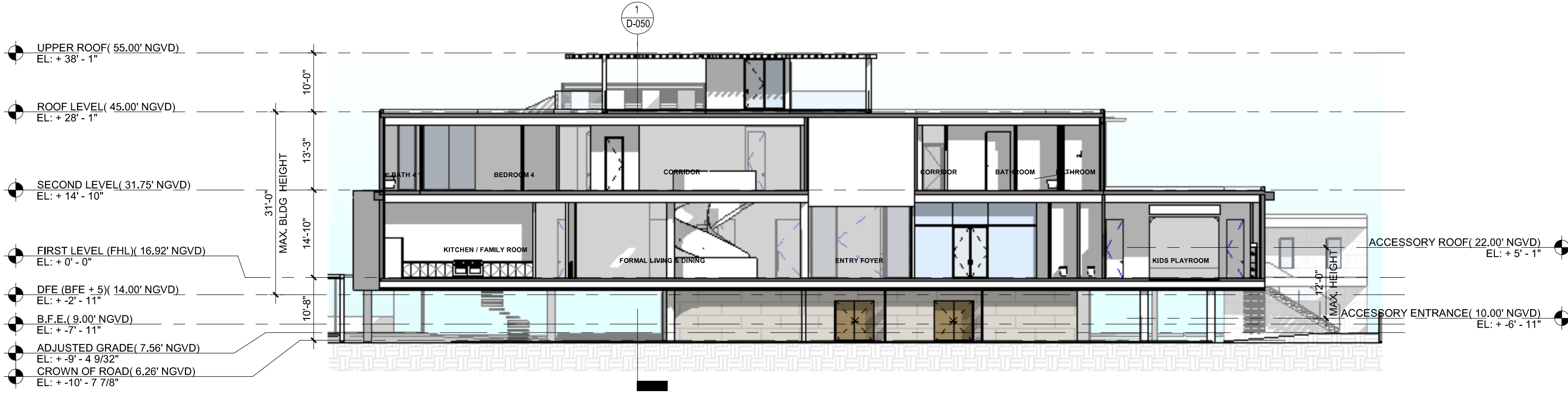

2 Section 1
1/16" = 1'-0"

SCOPE OF WORK

NEW CONSTRUCTION OF SINGLE FAMILY RESIDENCE WITH UNDERSTORY, POOL, TERRACES, PROPERTY WALLS AND FENCING, DRIVEWAY, AND LANDSCAPING

VARIANCE REQUEST 1: Provide an enclosed, air-conditioned storage area within the understory.

VARIANCE REQUEST 2: Provide concrete area within the understory for structural purposes surrounding support columns and pool areas

VARIANCE REQUEST 3: Exceed the maximum permitted lot coverage by 4.15% to provide an operable aluminum trellis, rather than a trellis with fabric covering, that exceeds a projection of five (5) feet from the exterior wall.

VARIANCE REQUEST 4: Provide mechanical equipment and screening elements in side yard to exceed maximum height of B.F.E. + 5'.

PROPERTY OWNER

94 PALM RESIDENCE LLC

ARCHITECT

BORGES ARCHITECTS + ASSOCIATES

237 S Dixie Hwy, Floor 4, Suite 419
Coral Gables, Florida 33131
O: 305.374.9216

Reinaldo Borges - rborges@borgesarchitects.com
Emilia Garcia - egarcia@borgesarchitects.com

LANDSCAPE ARCHITECT

L&ND

7294 NW 1st Court
Miami, FL
O: +1-614-439-4895
Matthew Lewis - matt@land.design

SHEET INDEX

ARCHITECTURE

D-000	COVER
D-001	INDEX & SITE LOCATION
D-002.a	RENDER
D-002.b	RENDER
D-002.c	RENDER
D-002.d	RENDER
D-002.e	RENDER
D-002.f	RENDER
D-002.g	RENDER
D-002.h	RENDER
D-005	NEIGHBORHOOD ANALYSIS
D-010	ZONING DATA
D-011	NET LOT AREA CALCULATION
D-012	SITE PLAN
D-013	GRADE LEVEL PLAN
D-014	FIRST LEVEL FLOOR PLAN
D-015	SECOND LEVEL FLOOR PLAN
D-016	ROOF LEVEL FLOOR PLAN
D-020	LOT COVERAGE DIAGRAM
D-021	UNIT SIZE DIAGRAM
D-022	UNIT SIZE DIAGRAM
D-023	UNIT SIZE DIAGRAM
D-024	UNIT SIZE DIAGRAM
D-032	VARIANCE 1 - DIAGRAM
D-033.a	VARIANCE 2 - DIAGRAM
D-033.b	VARIANCE 2 - DIAGRAM
D-033.c	VARIANCE 2 - DIAGRAM
D-033.d	VARIANCE 2 - DIAGRAM
D-033.e	VARIANCE 2 - DIAGRAM
D-034.a	VARIANCE 3 - DIAGRAM
D-034.b	VARIANCE 3 - DIAGRAM
D-034.c	VARIANCE 3 - DIAGRAM
D-034.d	VARIANCE 3 - DIAGRAM
D-034.e	VARIANCE 3 - DIAGRAM

D-035.a	VARIANCE 4 - DIAGRAM
D-035.b	VARIANCE 4 - DIAGRAM
D-035.c	VARIANCE 4 - DIAGRAM
D-035.d	VARIANCE 4 - DIAGRAM
D-035.e	VARIANCE 4 - DIAGRAM
D-040	RENDERED NORTH ELEVATION
D-041	RENDERED SOUTH ELEVATION
D-042	RENDERED EAST ELEVATION
D-043	RENDERED WEST ELEVATION
D-045	NORTH ELEVATION
D-046	SOUTH ELEVATION
D-047	EAST ELEVATION
D-048	WEST ELEVATION
D-050	SECTION

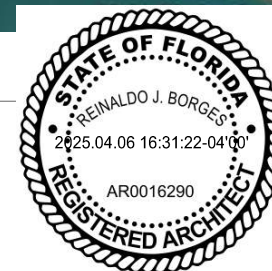

SINGLE FAMILY RESIDENTIAL - ZONING DATA SHEET

ALL INFORMATION REQUIRED BELOW MUST BE SUBMITTED AS REQUESTED. THE FORMAT OF THIS DOCUMENT MAY NOT BE MODIFIED OR ALTERED IN ANY WAY. SUBMITTALS FOUND INSUFFICIENT OR INCOMPLETE MAY FAIL THE REVIEW

ITEM #	Project Information				
1	Address:	94 PALM AVENUE MIAMI BEACH, FL 33139			
2	Folio number(s):	02-4205-001-0330			
3	Board and file number(s) :	DRB25-1087			
4	Year built: 2003	Zoning District:	RS-1		
5	Located within a Local Historic District (Yes or No):	NO			
6	Individual Historic Single Family Residence Site (Yes or No):	NO			
7	Home determined Architecturally Significant by CMB (Yes or No):	NO			
8	Base Flood Elevation:	9 & 10	Grade value in NGVD:	6.12'	
9	Adjusted grade (Flood+Grade/2): and Future adjusted grade	(9+6.12)/2=7.56'	Free board:	5	
10	30" above grade:	8.62	Lot Area:	6,000 SF, SEAWALL CENTER, 62,081.75	
11	Lot width:	200'	Lot Depth:	320'	
12	Max Lot Coverage SF and %:	18,624.53 SF / 30%	Proposed Lot Coverage SF and %:	21,202 SF / 34.15%	
13	Existing Lot Coverage SF and %:		Net Lot coverage (garage-storage)	N/A	
14	Front Yard Open Space SF and %:	4,228 SF / 70.47%	Rear Yard Open Space SF and %:	6,528 SF / 70.18%	
15	Max Unit Size SF and %:	31,040.88 SF / 50%	Proposed Unit Size SF and %:	29,414 SF / 47.38%	
16	Existing First Floor Unit Size:		Proposed First Floor Unit Size:	10,637 SF	
17	Proposed Roof Deck Area SF and % (Note: Maximum is 25% of the enclosed floor area immediately below):	1,947 SF / 20.21%			
18	Signed and sealed Landscape Plans (Tree/Vegetation Survey, Tree Disposition Plan, and Irrigation Plan).	Yes or No:	YES		
	ZONING INFORMATION / CALCULATION	Required	Existing	Proposed	Deficiencies
19	Height measured from B.F.E. plus freeboard	31'		31'	N/A
20	Front Setbacks:	30'		65'-7"	N/A
	Front First level:	20'		92'-1"	N/A
	Front second level:	30'		65'-7"	N/A
21	Front second level if lot coverage is 25% or greater:				
	a) At least 35% of the front façade shall be setback 5' from the minimum required setback.	35'		65'-7"	N/A
	b) At least 50% of the second floor along a side elevation facing a street shall be setback 5' from the minimum required setback.	N/A		N/A	N/A
22	Sum of side yard :	50'-0"		50'-0"	N/A
23	Side 1:	20'-0"		20'-0"	N/A
24	Side 2 or (facing street):	20'-0"		30'-0"	N/A
25	Rear:	46'-5 3/4"		123'-2"	N/A
26	Accessory Structure Side 1:	7'-6"		7'-6" / 20'-0"	N/A
27	Accessory Structure Side 2 or (facing street) :	7'-6"		7'-6" / 30'-0"	N/A
28	Accessory Structure Rear:	23'-3"		23'-3"	N/A
30	Additional data or information that may be applicable to the project shall be provided in the following fields.				

Notes: Indicate N/A if not applicable.

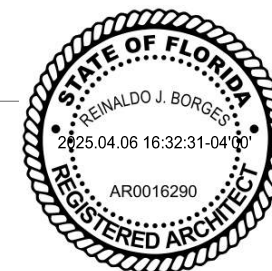

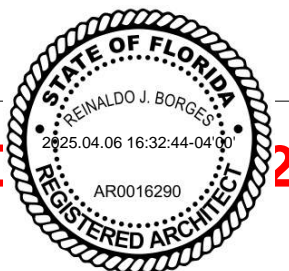
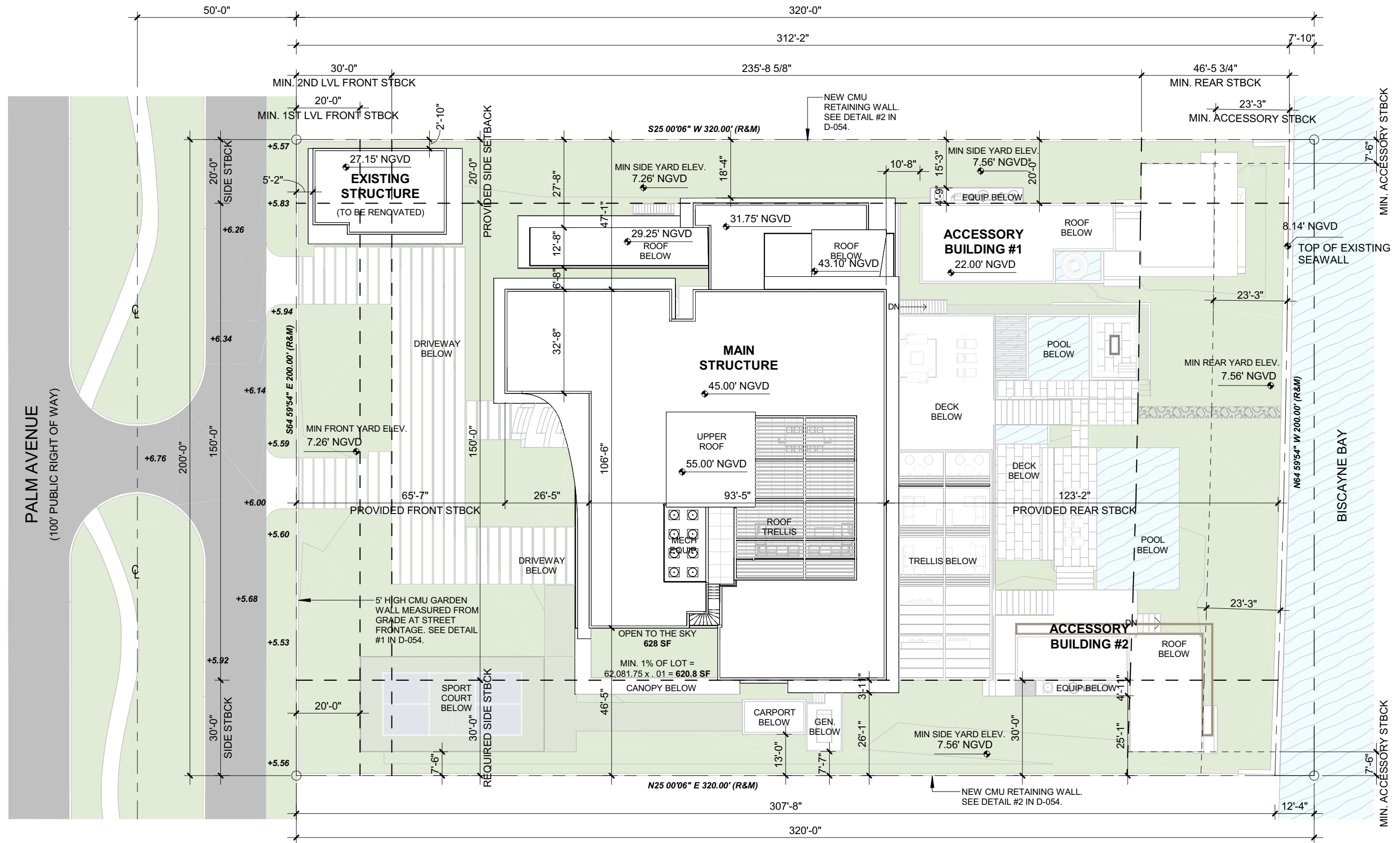

EXISTING STRUCTURE
1,002 SF

ENCLOSED STORAGE 1 &
MECH. ROOM
1,755 SF

ENCLOSED STORAGE 2
111 SF

ACCESSORY BUILDING #1A
1,316 SF

ACCESSORY BUILDING #1B
702 SF

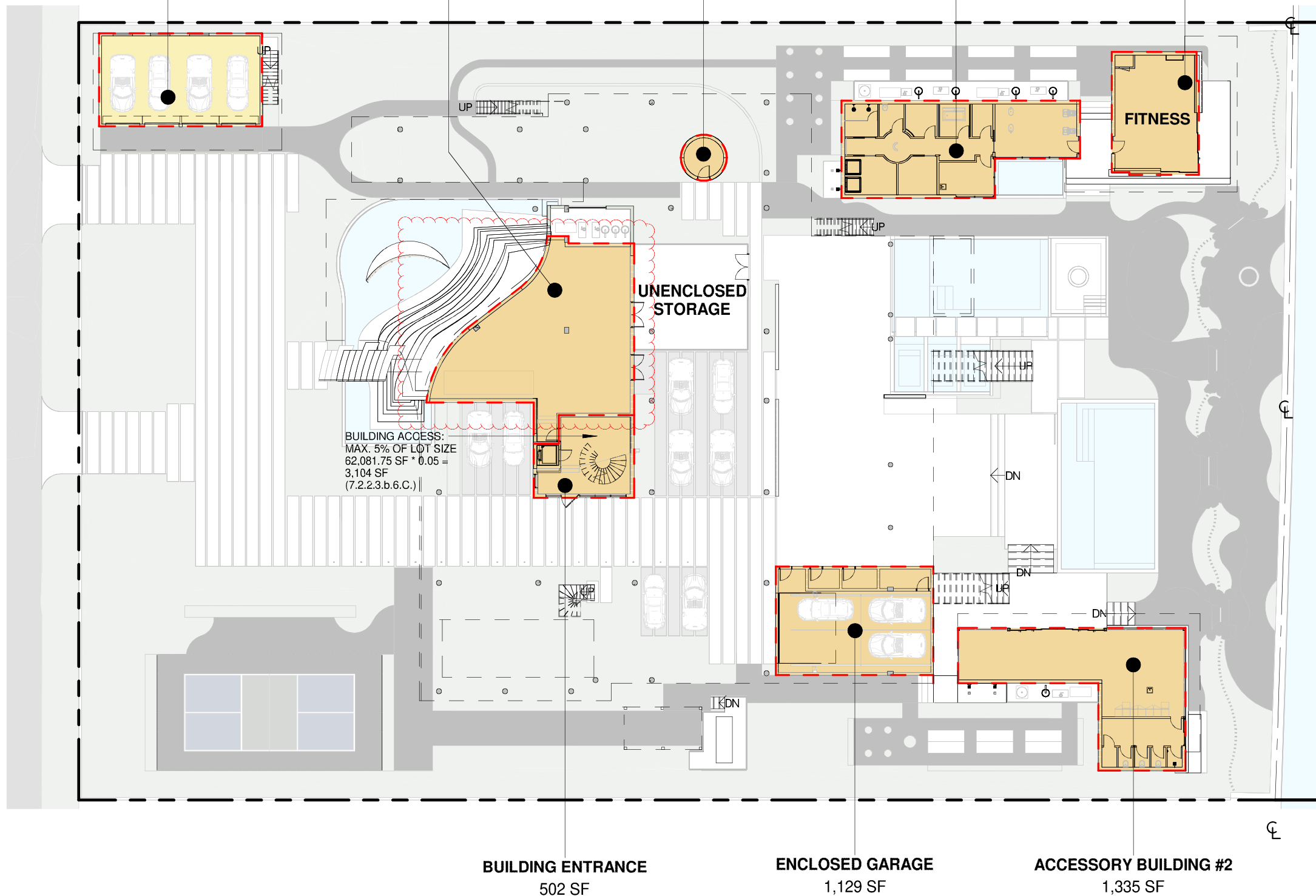

MAXIMUM UNIT SIZE (SF)	
LOT AREA = 62,081.75	
ALLOWABLE	
50% OF LOT AREA	
62,081.75 x .50 = 31,040.88	
PROVIDED	
UNDERSTORY LEVEL	
BUILDING ENTRANCE	423
ENCLOSED STORAGE 1 & MECH.	1,755
ENCLOSED STORAGE 2	111
ENCLOSED GARAGE	1,129
ACCESSORY BLDG #1A	1,316
ACCESSORY BLDG #1B	702
ACCESSORY BLDG #2	1,335
EXISTING BLDG	1,002
TOTAL	7,773
FIRST LEVEL	
MAIN STRUCTURE	10,637
EXISTING BLDG	1,093
TOTAL	11,730
SECOND LEVEL	10,214
ROOF LEVEL	297
TOTAL	30,014
	48.35%
GARAGE CREDIT	-600.00
TOTAL	29,414
	47.38%

1 UNDERSTORY LEVEL
1" = 30'-0"

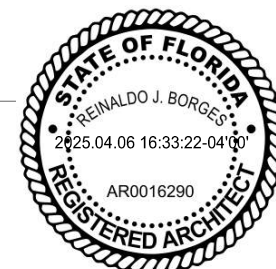

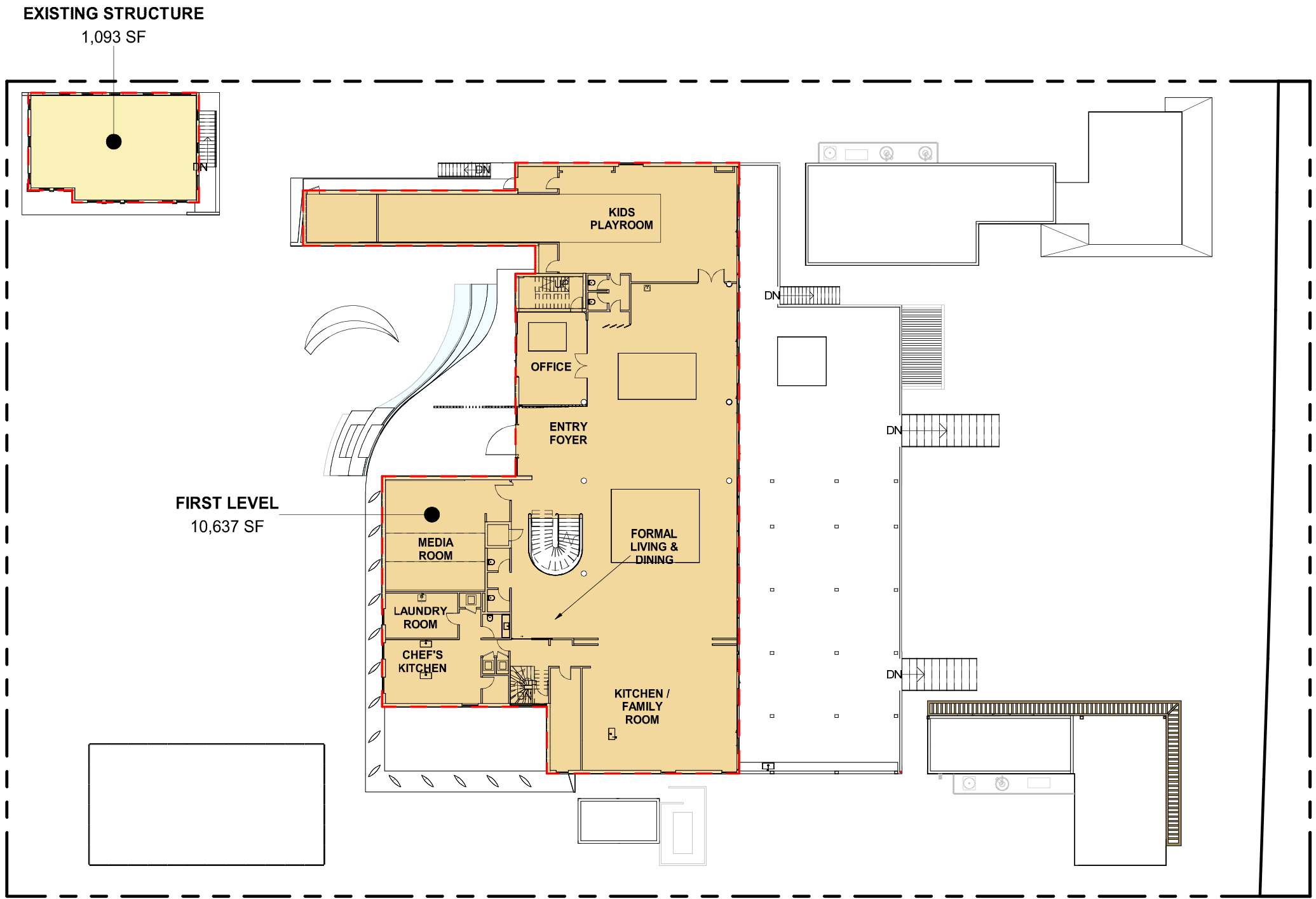

1 FIRST MAIN FLOOR
1" = 30'-0"

MAXIMUM UNIT SIZE (SF)	
LOT AREA = 62,081.75	
ALLOWABLE	
50% OF LOT AREA	
62,081.75 x .50 = 31,040.88	
PROVIDED	
UNDERSTORY LEVEL	
BUILDING ENTRANCE	423
ENCLOSED STORAGE 1 & MECH.	1,755
ENCLOSED STORAGE 2	111
ENCLOSED GARAGE	1,129
ACCESSORY BLDG #1A	1,316
ACCESSORY BLDG #1B	702
ACCESSORY BLDG #2	1,335
EXISTING BLDG	1,002
TOTAL	7,773
FIRST LEVEL	
MAIN STRUCTURE	10,637
EXISTING BLDG	1,093
TOTAL	11,730
SECOND LEVEL	10,214
ROOF LEVEL	297
TOTAL	30,014
	48.35%
GARAGE CREDIT	-600.00
TOTAL	29,414
	47.38%

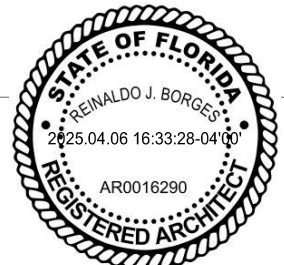

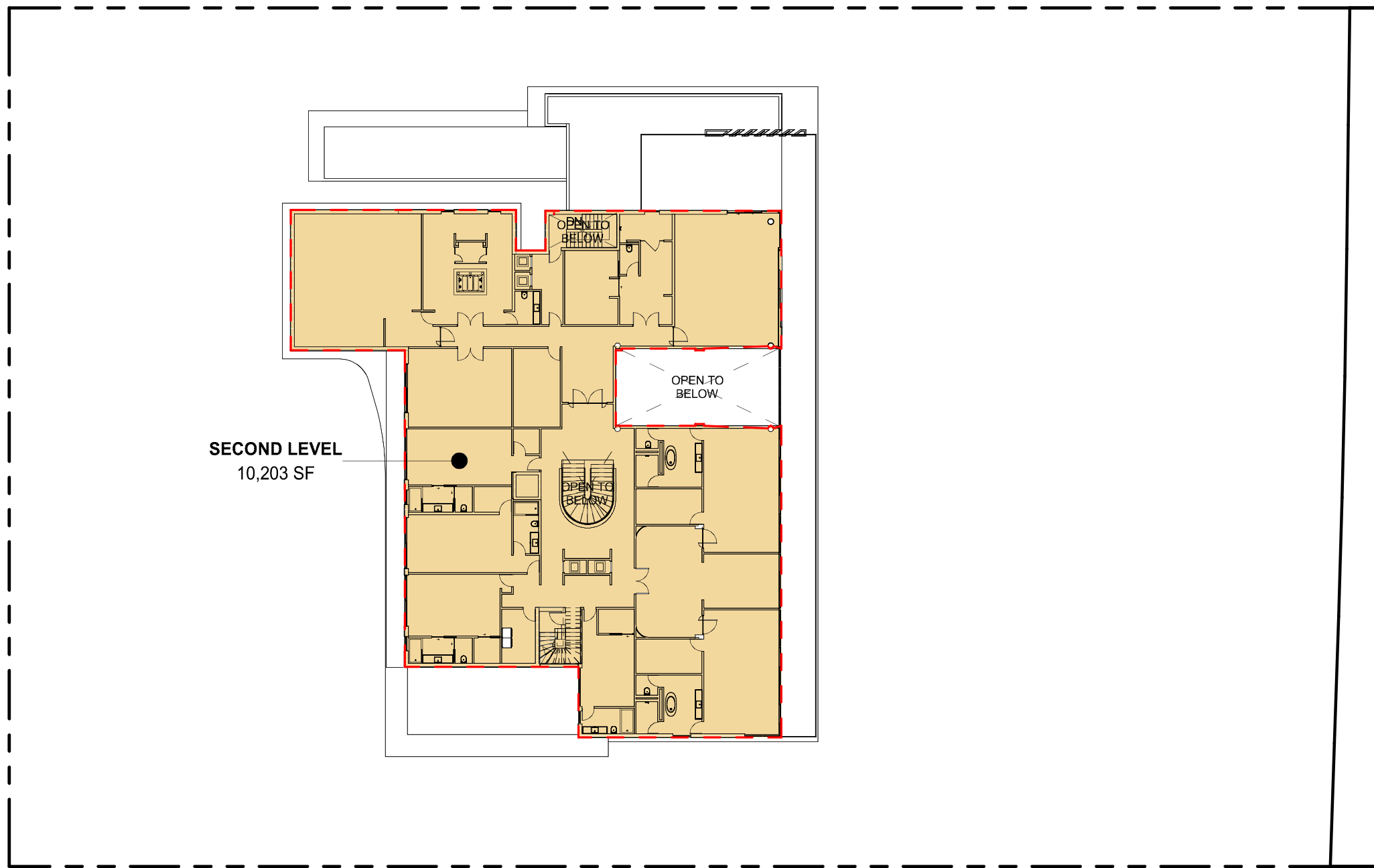

1 SECOND LEVEL
1" = 30'-0"

MAXIMUM UNIT SIZE (SF)	
LOT AREA = 62,081.75	
ALLOWABLE	
50% OF LOT AREA	
62,081.75 x .50 =	31,040.88
PROVIDED	
UNDERSTORY LEVEL	
BUILDING ENTRANCE	423
ENCLOSED STORAGE 1 & MECH.	1,755
ENCLOSED STORAGE 2	111
ENCLOSED GARAGE	1,129
ACCESSORY BLDG #1A	1,316
ACCESSORY BLDG #1B	702
ACCESSORY BLDG #2	1,335
EXISTING BLDG	1,002
TOTAL	7,773
FIRST LEVEL	
MAIN STRUCTURE	10,637
EXISTING BLDG	1,093
TOTAL	11,730
SECOND LEVEL	10,214
ROOF LEVEL	297
TOTAL	30,014
	48.35%
GARAGE CREDIT	-600.00
TOTAL	29,414
	47.38%



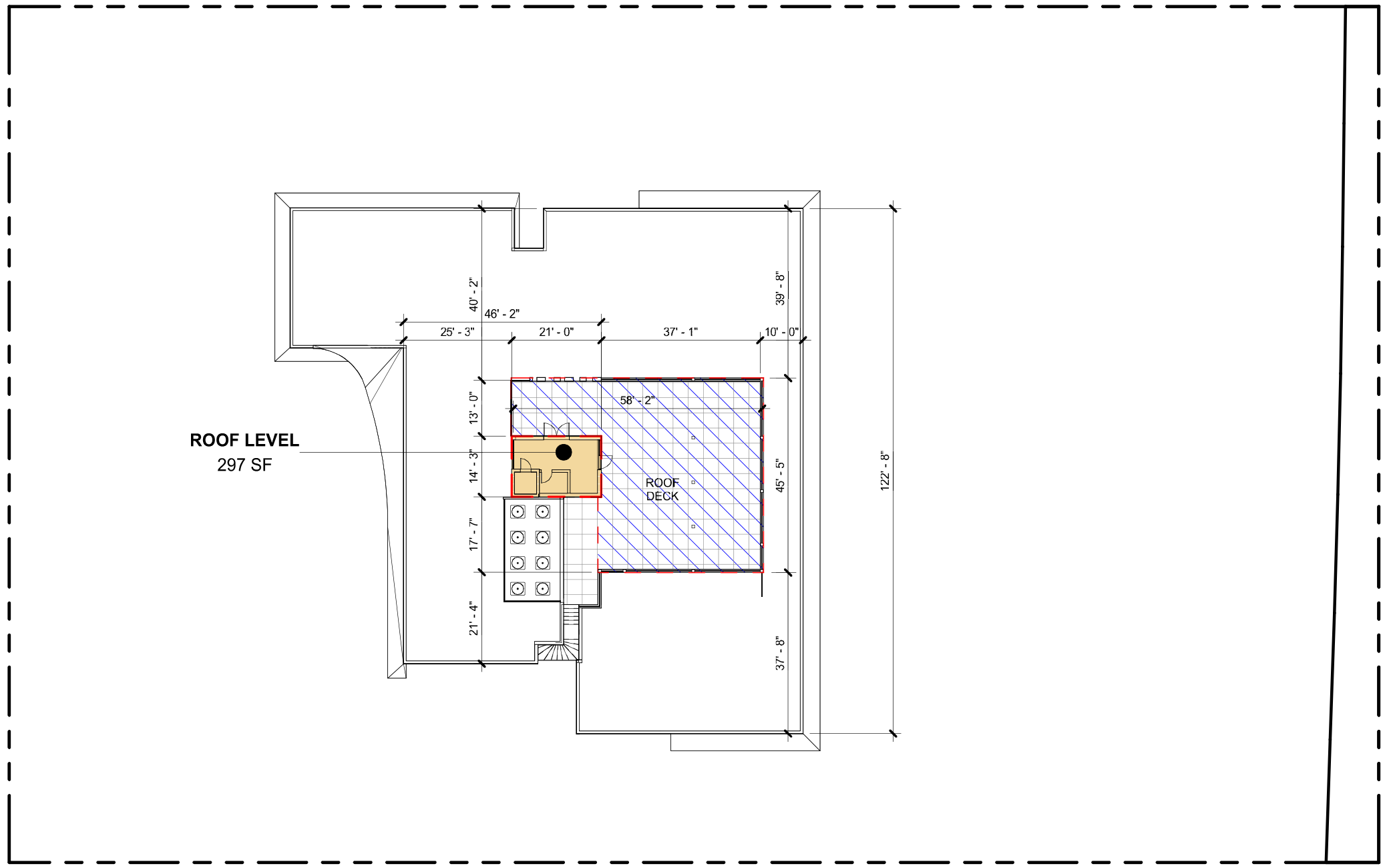

ROOF LEVEL
297 SF

1 ROOF LEVEL
1" = 30'-0"

MAXIMUM UNIT SIZE (SF)	
LOT AREA = 62,081.75	
ALLOWABLE	
50% OF LOT AREA	
62,081.75 x .50 =	31,040.88
PROVIDED	
UNDERSTORY LEVEL	
BUILDING ENTRANCE	423
ENCLOSED STORAGE 1 & MECH.	1,755
ENCLOSED STORAGE 2	111
ENCLOSED GARAGE	1,129
ACCESSORY BLDG #1A	1,316
ACCESSORY BLDG #1B	702
ACCESSORY BLDG #2	1,335
EXISTING BLDG	1,002
TOTAL	7,773
FIRST LEVEL	
MAIN STRUCTURE	10,637
EXISTING BLDG	1,093
TOTAL	11,730
SECOND LEVEL	10,214
ROOF LEVEL	297
TOTAL	30,014
TOTAL	48.35%
GARAGE CREDIT	-600.00
TOTAL	29,414
TOTAL	47.38%

ROOF STANDARDS			
	ALLOWABLE	PROVIDED	COLOR LEGEND
ROOF DECK AREA			
25% OF ENCLOSED FLOOR BELOW		2,113 SF PROVIDED	
AREA OF LEVEL BELOW=10,214			
10,214 SF x .25 = 2,553.5 SF ALLOWED		20.69%	
ROOF COVERED STRUCTURE			
20% OF ENCLOSED FLOOR BELOW		2,023 SF PROVIDED	
AREA OF LVL BELOW = 10,214			
10,214 SF x .20 = 2,042.8 SF ALLOWED		19.81%	

