

HISTORIC RESOURCES REPORT



1800 Michigan Avenue, Miami Beach, FL 33139

Report prepared by:

Studio Mc+G Architecture
Jennifer McConney-Goyoso

230 NE 97th Street | Miami Shores, FL 33138
Office (305) 573-2728



PRELIMINARY REMARKS:

The present report and attached documents comprise a survey of the property located at 1800 Michigan Avenue in Miami Beach, Florida. The project site is located in the Palm View Historic District. The subject building is surrounded by vacant lots 2 (1810 Michigan Avenue), 3 (1818 Michigan Avenue) and 4 (1039 18th Street) on block 10 at the intersection of Michigan Avenue and 18th street. This report has been prepared in anticipation of the proposal for the design of a single-family residence at 1800 Michigan Avenue. The attached study provides an overview of the existing structure based on photo surveys, historical documents and newspaper articles. The report includes, among other references, the City of Miami Beach Building Card documenting the permit history of the property. The proposed modification is designed to significantly abstract and celebrate the design features of the original house and its historical resources, in a manner consistent with the site's proposed development rights.

HISTORY of 1800 Michigan Avenue

This contributing building, under legal description 34 53 42 PALM VIEW SUB PB 6-29 LOT 1 BLK 10 stands at the intersection of Michigan Avenue and 18th street. It is recorded as built in 1935, by the firm of Carlos B. Schoeppl and Southwell. Miami Beach's historic property viewer online lists more than 20 contributing properties, including 1827 Michigan Ave (across the street from the subject property) as being designed by his firm.⁸

An article regarding the Miami Design Preservation League's position on the proposed redesignation of 603 E Dildo Drive states "Carlos B. Schoeppl was born in 1898 in Comfort, Texas. He studied at the Ecole des Beaux Arts in Paris and the Royal Academy in London. He first practiced in Houston and San Antonio, Texas. Two of his Houston commissions have received recognition: The Fred J. Heyne house is listed on the National Register and the Bryan-Chapman is designated with a Texas Historical Marker. In 1926, he traveled to Jacksonville, Florida, to convalesce from an illness and decided to set up practice in Florida to take advantage of the building boom. He came to Miami Beach in 1929 and entered into a partnership with Arnold Southwell in 1931. From a small office at 527 Lincoln Road, they moved across the street to 528 Lincoln to accommodate the growth in commissions. At the height of their practice, the partnership employed fifteen men in designing houses, hotels, stores, and apartment buildings. By 1935, their practice was receiving national press. *Print Magazine* featured them in an article titled "Profits from Small Houses (To This Office Come . . .)" that showcased Southwell's own residence while the *American Architect* published a residence designed for J.E. Yonge in an issue devoted to Miami Beach architecture. The latter journal praised Schoeppl and other Miami Beach artists for their ability to define 'American Architecture' by 'cleverly expressing the phrase in terms of building design.'

A year later, Schoeppl and Southwell dissolved their partnership. In 1937, he designed the Sunset Island residence for William and Lura Fisher. Schoeppl moved his practice to Clearwater and formed Carlos B. Schoeppl & Associates in 1969. The focus of his Clearwater practice was the design and construction of motels. Schoeppl died in 1990 at the age of 91."⁹

Historic documents demonstrate that the 1800 Michigan Avenue house sustained damages from hurricane Irene in 1999.

Despite extensive research extending to local agencies and libraries, available imagery of the existing structure is limited to a few photographs of the façade and a few aerial photographs depicting the numerous unpermitted additions carried out over the span of decades, which cross setbacks and even property lines. Through illegal additions and changes, such as the replacement of larger windows at the south façade with the small ones that remain today, the property retains little of its original character.



1969 view facing SW on Michigan Ave

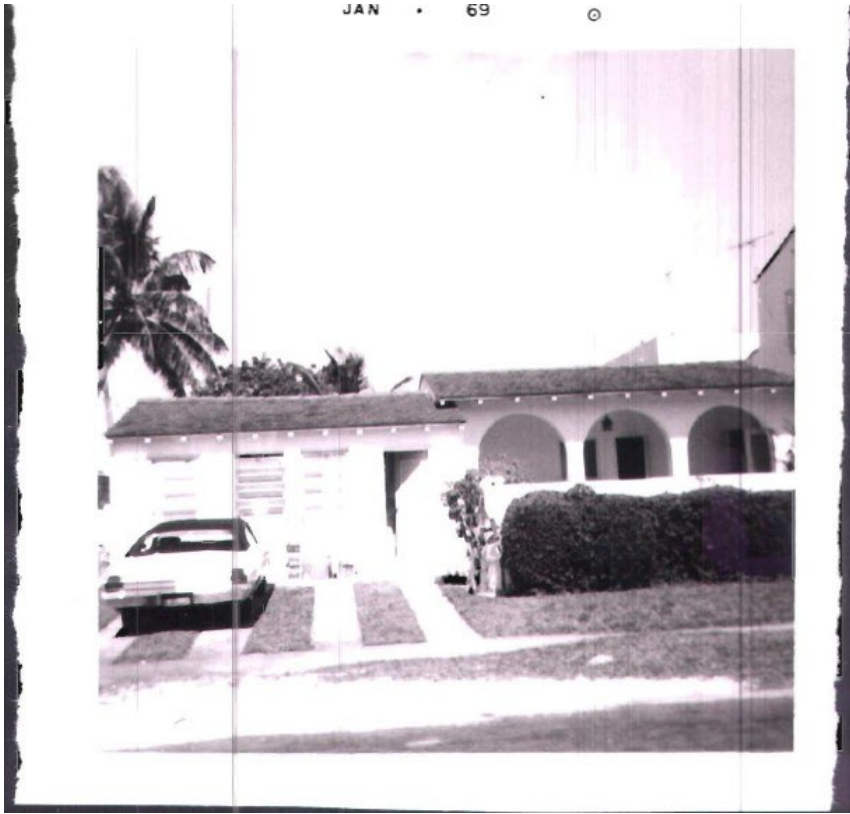

1969 view facing north on 18th street



1969 view facing NW at the intersection of Michigan Ave and 18th street



VIEW OF EXISTING DRIVEWAY SHOWING ILLEGAL ADDITION REACHING THE PROPERTY LINE AND LOCATION OF ORIGINAL GARAGE



VIEW OF EXISTING MAIN ENTRY



DETAILS OF EXISTING ENTRY

The celebrated, pronounced main entry seems to be a gesture in other Schoeppl homes such as 1753 North View Drive, 1228 Collins Ave, 1446 Meridian Ave and 1446 Meridian Avenue among others.



view of 1753 North View Drive by Carlos Schoeppl



view of 1753 1228 Collins Avenue by Carlos Schoepl



view of 1446 Meridian Avenue and of 2811 Indian Creek Drive by Carlos Schoepl

The proposed house, in similarity to the current one, stands far back from its Michigan avenue setback, allowing significant space between it and the road. It is difficult to appreciate the existing house's south façade fully, as it is concealed by large trees. It is apparent that the original design had larger windows, which were illegally replaced by much smaller ones. The non permitted additions form a large part of this façade, including a large uncovered patio screen which reaches the property line. Horizontal reveals also form part of the south façade, which the proposed design integrates.



REVEALS ON EXISTING SOUTH FACADE

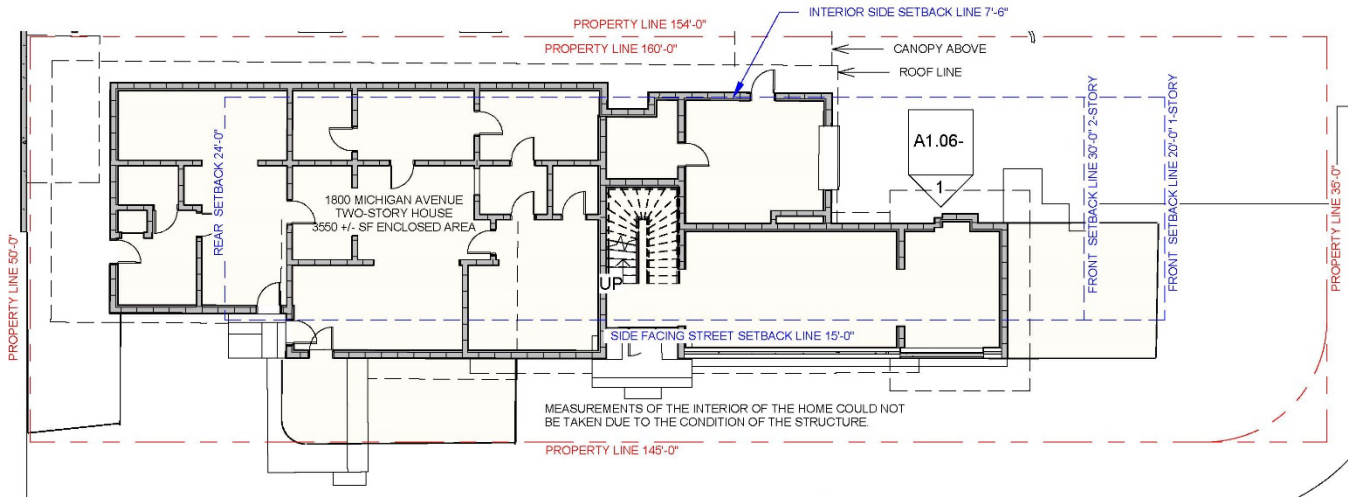

PLAN OF EXISTING HOME: FLOOR 1

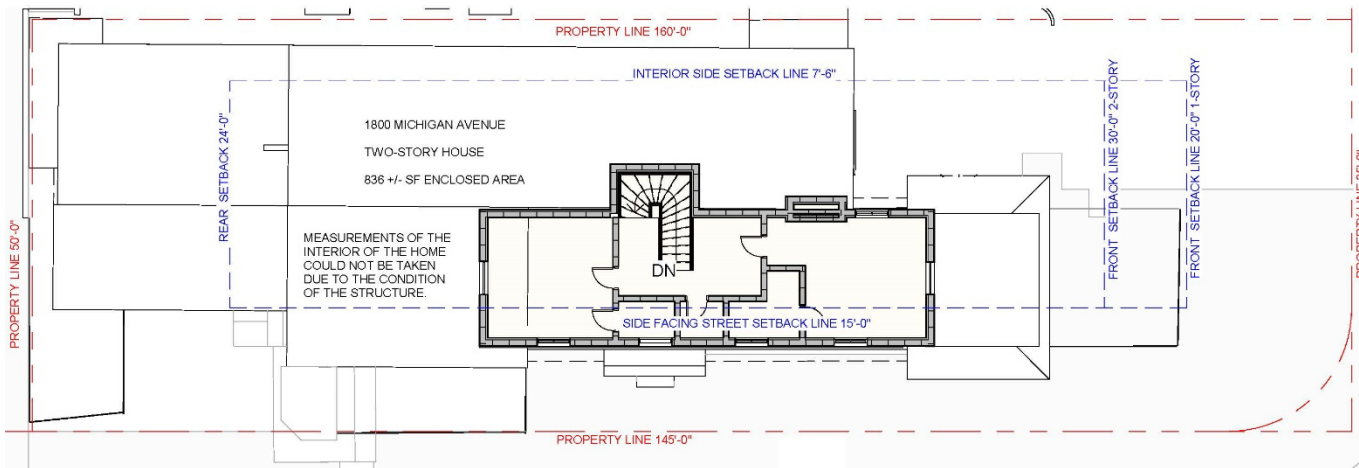

PLAN OF EXISTING HOME: FLOOR 2

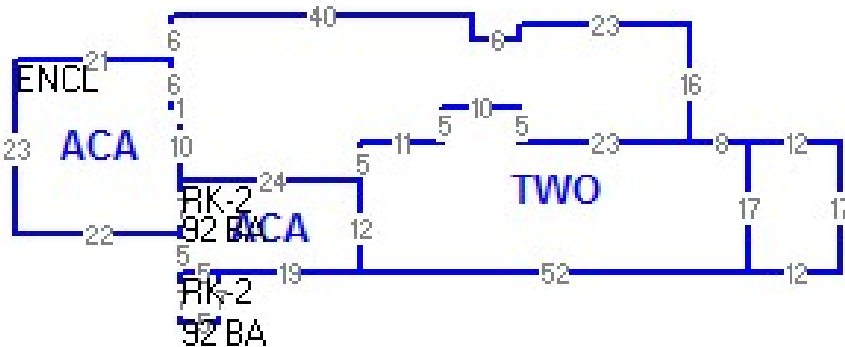

BUILDING SKETCH FROM MIAMI DADE PROPERTY RECORDS

PHOTO SURVEY:



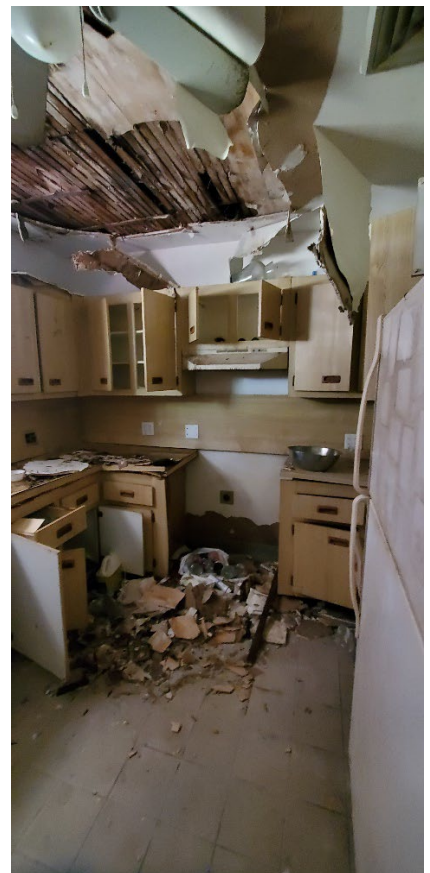
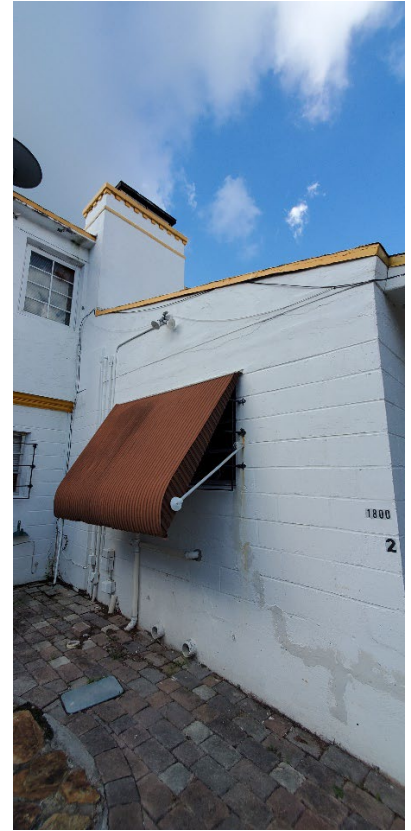
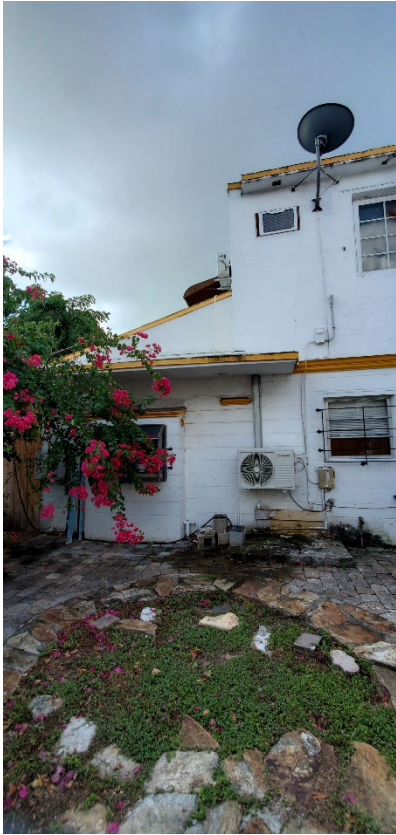



BUILDING CARD:

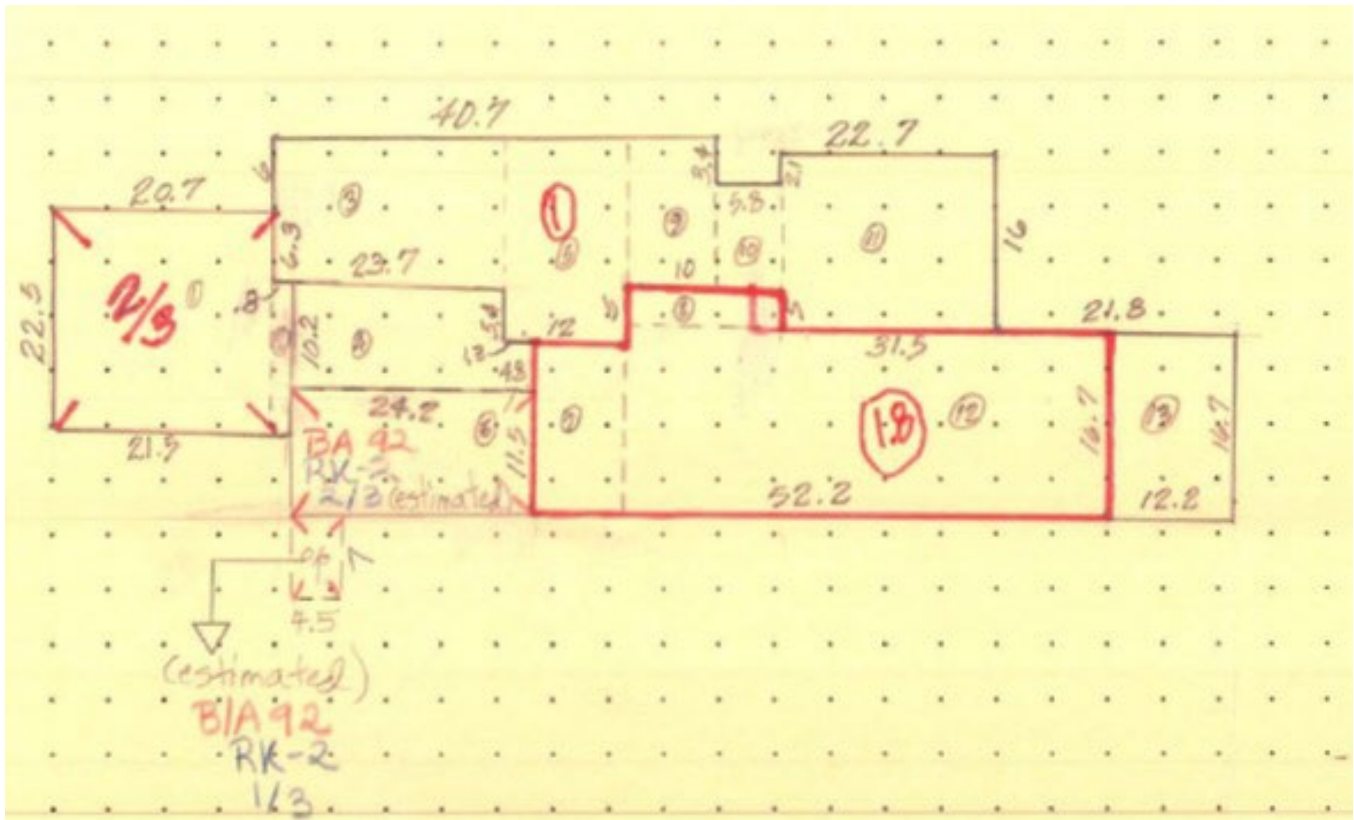

1800 MICHIGAN AVE S-2875(2997) 594250071
DATE: 4/27/53
LEGAL: 1 of 10, Palm View SIZE: 50x160
OWNER: Ben Yoman (rec Goichberg) PHONE: 5-4428
TERMS: Cash above mtg.
FRN: Aver TRAN: 2 blks CST: CBS
PMT: 2/35 LAWN: Excel CON: Excel
TAX: \$571.94 WHE SHOP: Lincoln Rd LSP: Excel
OCC: IMOC SHUT: Yes LDS: Yes
2/2up, 1/1dn, LR, DR, KwER/GS, Walled-in Patio,
GEP, 2-c w 1/1.
NOTE: SS
PHOTO-LISTING
9513 HARDING AVENUE PH: 86-1466

ORIGINAL DRAWINGS

Not available

END OF REPORT

1. The Miami Herald (Miami, Florida) Oct 28, 2012
2. The Miami Herald (Miami, Florida) Oct 30, 1921
3. The Miami News (Miami, Florida) Oct 24, 1926
4. RE: Miami Beach <https://www.remiamibeach.com/>
5. Miami Beach Studio Home of Henry Salem Hubbell <https://tinyurl.com/yc6nfp6r>
6. The Miami News (Miami, Florida) Jan 11, 1921
7. <https://naturalatlas.com/canals/collins-979450>
8. <https://apps.miamibeachfl.gov/histpropviewer/>
9. <https://mdpl.org/blog/2021/02/save-1753-north-view-drive-sunset-island-home-of-body-by-fisher-automobile-inventor/>