



1901 Alton

Miami Beach, Florida 33139

prepared for:

Crecent Heights

traffic study

TRAFTECH
ENGINEERING, INC.

December 2023

December 1, 2023

Mr. Graham Penn
Bercow Radell & Fernandez, P.A.
200 S. Biscayne Boulevard, Suite 850
Miami, Florida 33131

Re: 1901 Alton - Traffic Study

Dear Graham:

Traf Tech Engineering, Inc. is pleased to provide you with the results of the traffic study associated with the proposed 1901 Alton development planned to be located at 1901 Alton Road in the City of Miami Beach in Miami-Dade County, Florida.

It has been a pleasure working with you on this project.

Sincerely,

TRAF TECH ENGINEERING, INC.

Joaquin E. Vargas, P.E.
Senior Transportation Engineer

INTRODUCTION

1901 Alton is a proposed development planned to be located at 1901 Alton Road in the City of Miami Beach in Miami-Dade County, Florida. The location of the project site is illustrated in Figure 1 on the following page.

Traf Tech Engineering, Inc. was retained by Crescent Heights to conduct a traffic study¹ in connection with the proposed development. The study addresses trip generation and the traffic impacts created by the proposed project on the nearby transportation network. This study is divided into seven (7) sections, as listed below:

1. Inventory
2. Existing Conditions
3. Traffic Counts
4. Trip Generation
5. Trip Distribution and Traffic Assignment
6. Traffic Impact Analysis
7. Conclusions and Recommendations

¹ The traffic methodology was discussed and agreed with the City of Miami Beach staff.



LEGEND	
	Subject Site

INVENTORY

Existing Land Use

6,654 square feet of Drive-in Bank

Proposed Land Uses and Access

The 1901 Alton project consists of the following land use and intensity:

- 34,953 square foot Supermarket
- 3,908 square foot Walk-in Bank

The access to the project's proposed parking garage will consist of the following:

- Full access driveway off of 19th Street

Appendix A contains a copy of the proposed site plan for the project site.

EXISTING CONDITIONS

This section addresses the existing roadway system located in the vicinity of the project site and nearby intersections.

Roadway System

The roadway system located near the project site includes Alton Road, Michigan Avenue, 20th Street, 19th Street, and Dade Avenue. Near the project site, Alton Road, Michigan Avenue, and Dade Boulevard are four-lane facilities, while 20th Street and 19th Street, are two-lane facilities.

Nearby Intersections

With the assistance of City of Miami Beach staff, five intersections (plus the future access driveway) were identified as the locations that will be impacted the most by the proposed project. These intersections include Alton Road and Michigan Avenue, Alton Road and 20th Street, Alton Road and 19th Street, Alton Road and Dade Boulevard, and Michigan Avenue and Dade Boulevard.

Figure 2 shows the existing lane geometry of the five intersections selected for analysis purposes. The number of lanes on the street system surrounding the project site is also depicted in the figure.

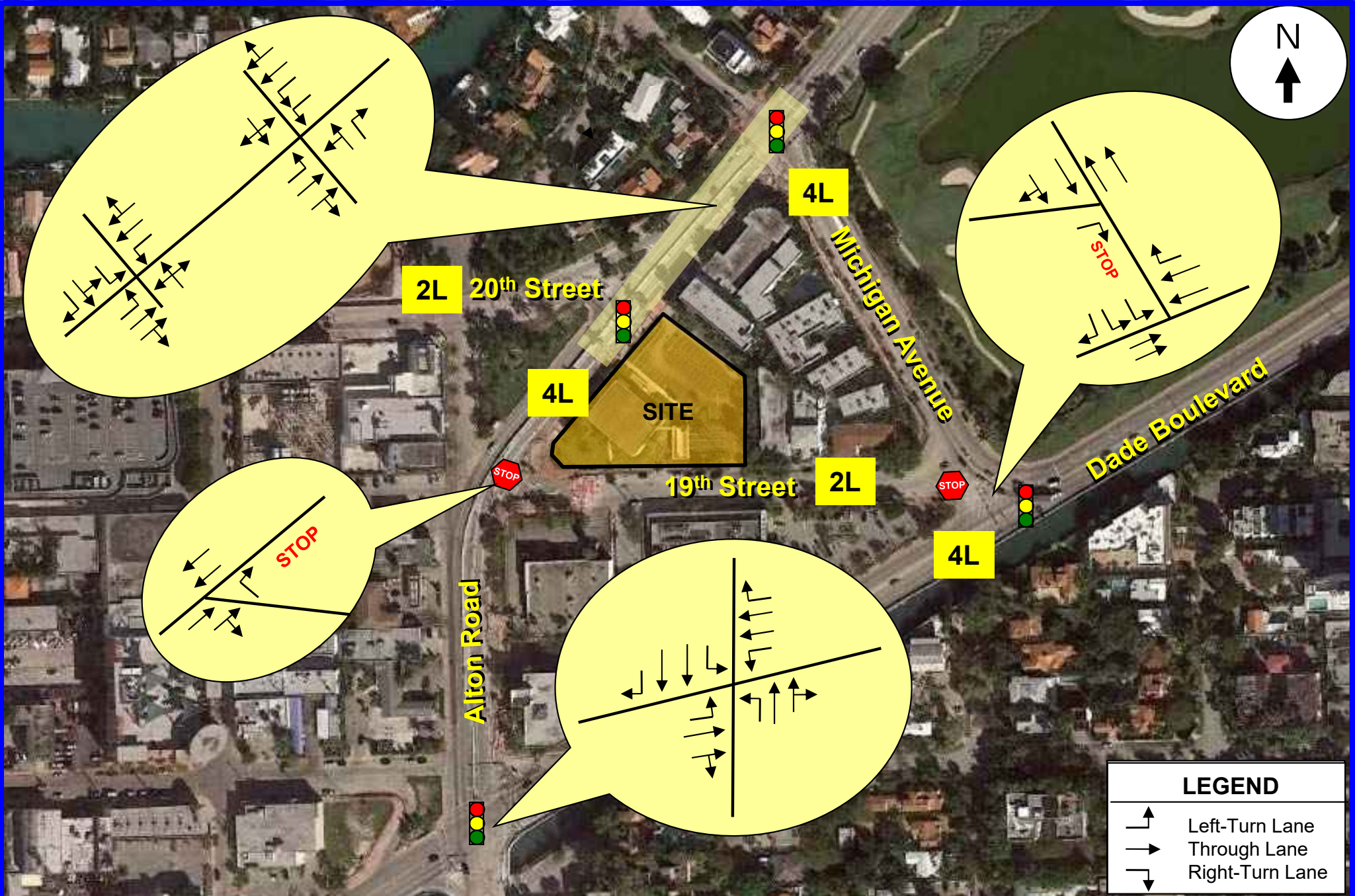

TRAFFIC COUNTS

Traf Tech Engineering, Inc., collected intersection turning movement counts at the six study intersections. The intersection turning movement counts were collected on Wednesday, August 9, 2023 from 7:00 AM and 9:00 AM and from 4:00 PM and 6:00 PM at the following intersections located near the project site:

1. Alton Road and Michigan Avenue (signalized intersection)
2. Alton Road and 20th Street (signalized intersection)
3. Alton Road and 19th Street (stop controlled)
4. Alton Road and Dade Boulevard (signalized intersection)
5. Michigan Avenue and Dade Boulevard (Signalized)

Figure 3 summarizes the results of the intersection turning movement counts undertaken during the weekday peak hours. Appendix B contains the intersection turning movement counts, as collected in the field. The signal timing plan for the signalized intersections were obtained from the Miami-Dade County's web site.

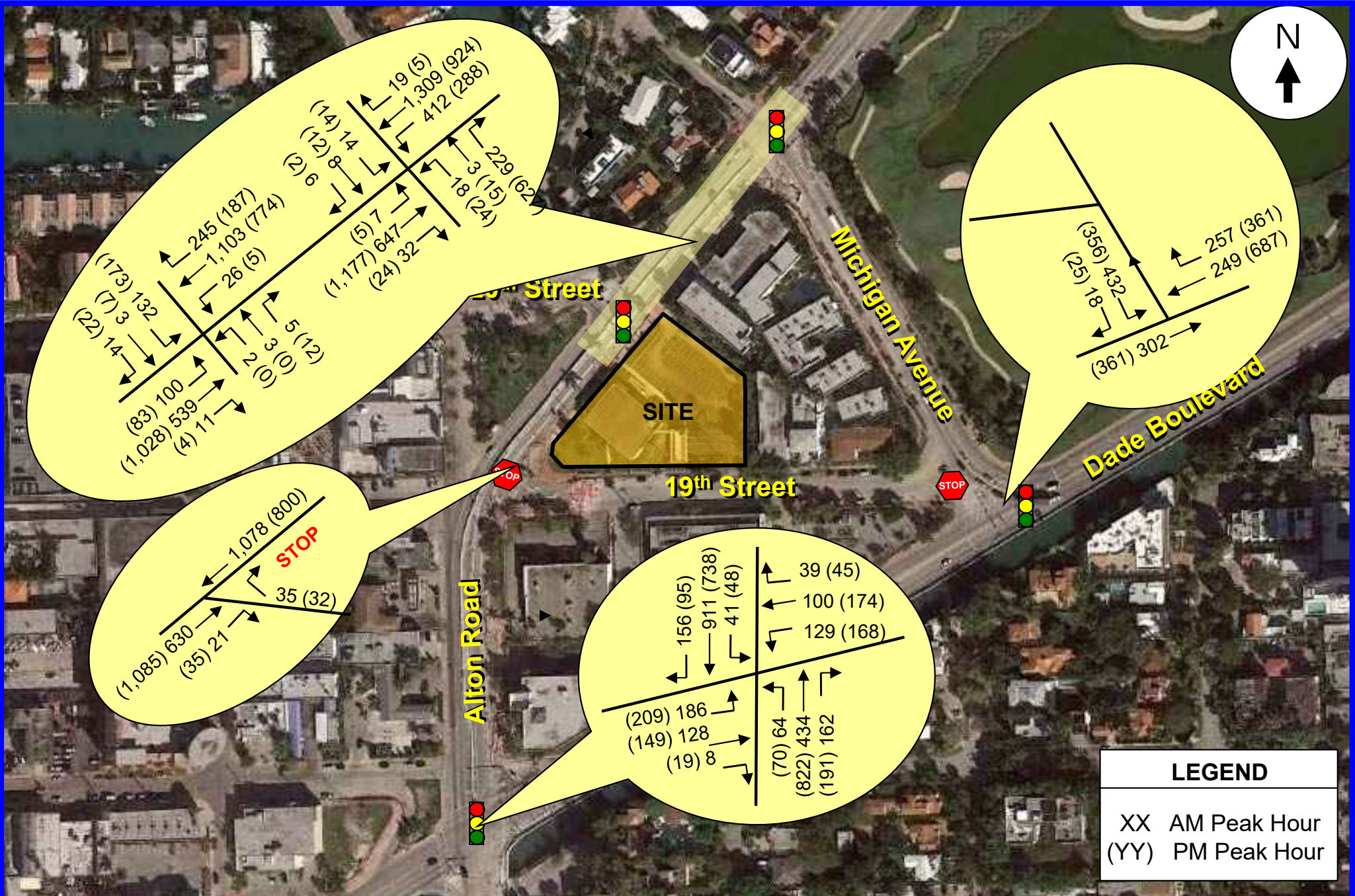

TRIP GENERATION

The trip generation for the project was based on information contained in the Institute of Transportation Engineer’s (ITE) *Trip Generation Manual* (11th Edition). According to the subject ITE manual, the most appropriate “land use” categories for existing and proposed land uses include Land Use 912 – Drive-in Bank, Land Use 850 – Supermarket, and Land Use 911 – Walk in Bank.

The trip generation analysis was undertaken for Daily, AM peak hour, and PM peak hour conditions. Using the trip generation equations from the ITE document, a trip generation analysis was undertaken for the proposed project. The results of this effort are documented in Table 1.

TABLE 1 Trip Generation Summary (Existing Use) 1901 Alton								
Land Use	Size	Daily Trips	AM Peak Hour			PM Peak Hour		
			Total Trips	Inbound	Outbound	Total Trips	Inbound	Outbound
Drive-in Bank (LUC 912)	6,654 sf	668	66	38	28	140	70	69
External Trips		668	66	38	28	139	70	69

Source: ITE Trip Generation Manual (11th Edition)

TABLE 1 Trip Generation Summary (Proposed Uses) 1901 Alton								
Land Use	Size	Daily Trips	AM Peak Hour			PM Peak Hour		
			Total Trips	Inbound	Outbound	Total Trips	Inbound	Outbound
Supermarket (LUC 850)	34,953 sf	3,454	101	60	41	314	157	157
Walk in Bank (LUC 911)	3,908 sf	n/a	n/a	n/a	n/a	48	21	27
External Trips		3,454	101	60	41	362	178	184

Source: ITE Trip Generation Manual (11th Edition)

Difference	Daily Trips	AM Peak Hour			PM Peak Hour		
		Total Trips	Inbound	Outbound	Total Trips	Inbound	Outbound
Proposed - Existing	2,786	35	22	13	223	108	115

As indicated in Table 1, the proposed project is anticipated to generate approximately 2,286 new daily trips, approximately 35 AM peak hour trips (22 inbound and 13 outbound) and approximately 223 trips during the typical afternoon peak hour (108 inbound and 115 outbound).

TRIP DISTRUBUTION AND TRAFFIC ASSIGNMENT

The trip distribution and traffic assignment for the project were based on Miami-Dade County's Cardinal Distribution information for the study area. Table 2 summarizes the County's cardinal distribution data for Traffic Analysis Zone 634, which is applicable to the project site from the latest SERPM data published by Miami-Dade County.

TABLE 2 Project Trip Distribution TAZ #634 for 1901 Alton								
Year	Movement							
	NNE	ENE	ESE	SSE	SSW	WSW	WNW	NNW
2015	16.6%	1.2%	2.7%	9.3%	19.0%	21.3%	10.8%	19.1%
2045	14.3%	0.8%	1.5%	7.9%	16.7%	27.8%	13.6%	17.4%
2026*	15.8%	1.1%	2.3%	8.8%	18.2%	23.7%	11.8%	18.5%

*Note: * Interpolated Values*

Source: Miami-Dade County (2015 & 2045 SERPM)

Using the trip distribution documented in Table 2, the following traffic assignment was assumed for the proposed development:

- 18% to and from the north via Alton Road
- 20% to and from the north via Dade Boulevard
- 6% to and from the west via Michigan Avenue
- 6% to and from the west via 20th Street
- 26% to and from the south north via Alton Road
- 24% to and from the south via Dade Boulevard

The new peak hour traffic generated by the project was assigned to the nearby transportation network using the traffic assignment documented above. The new project traffic assignment is summarized in Figure 4.

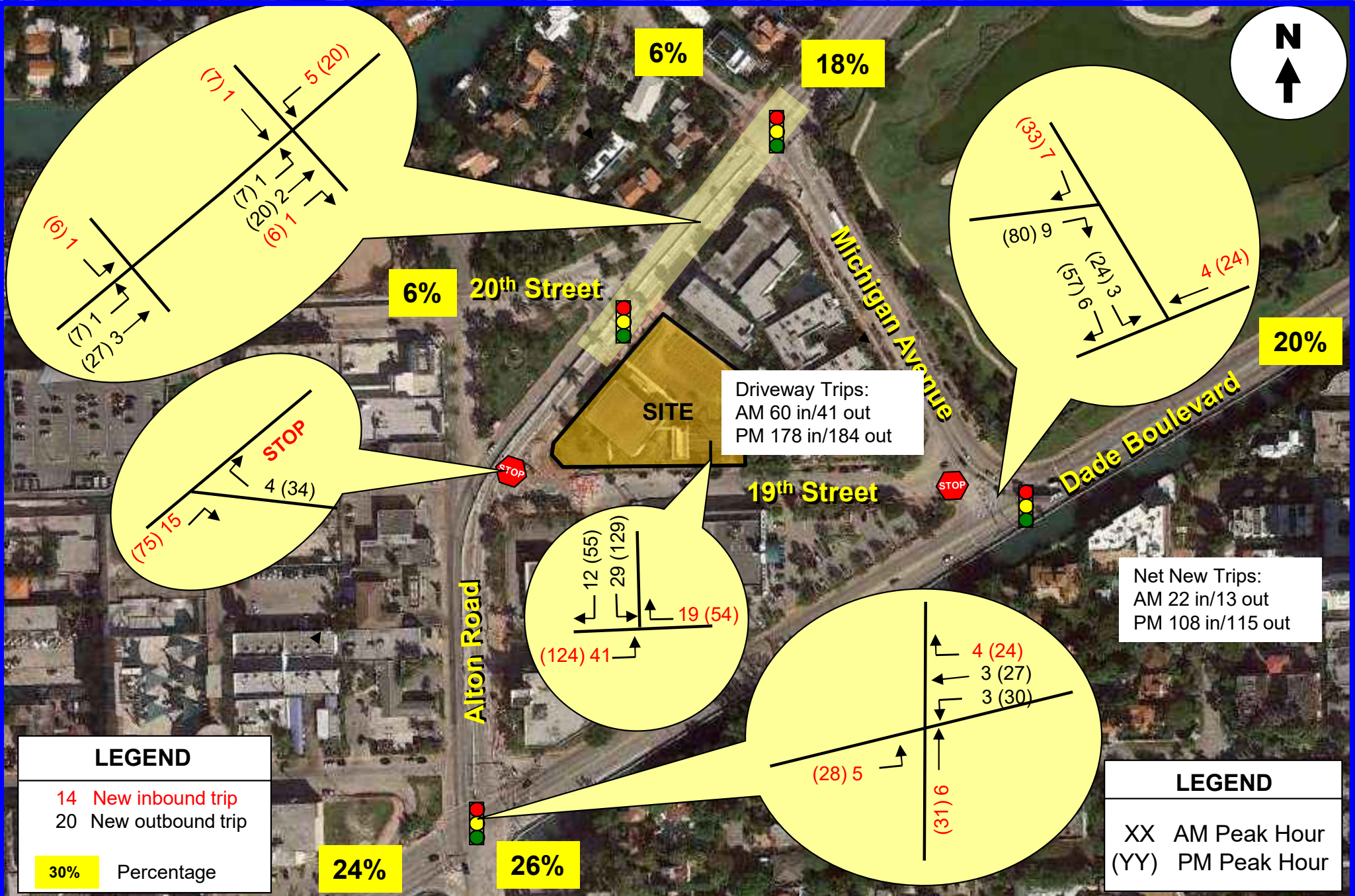

TRAFFIC ANALYSIS

This section of the study is divided into two parts. The first part consists of developing the future conditions traffic volumes for the study area. The second part includes level-of-service analyses for existing and future conditions.

Future Conditions Traffic Volumes

Two sets of future traffic volumes were developed. The first set includes project buildout conditions without the proposed project and the second set adds the new trips anticipated to be generated by the project.

In order to develop year 2026 traffic volumes (project anticipated to be built and occupied by the year 2026), without the proposed project, two separate analyses were undertaken. The first analysis converts the existing peak hour traffic counts collected in the field to average peak season conditions. Based on FDOT's Peak Season Factor Category report, a factor of 1.05 is required to convert collected traffic counts to average peak season conditions (refer to Appendix C). The second analysis includes a growth factor to project 2023 peak season traffic volumes to the year 2026. Based on traffic growth data published by the FDOT for a nearby traffic count stations, traffic growth has not occurred in the area. As documented in the historical and future growth analysis contained in Appendix C, a growth rate of 2.9%, compounded annually was used. In addition, project trips from committed development 1920 Alton Road were included.

The new trips generated by the proposed project (refer to Figure 4) were added to the 2026 background traffic in order to develop total traffic conditions. The future traffic projections for the study intersections are presented in tabular format in Appendix D. Figures 5 and 6 present the year 2026 future traffic volumes for the study area. Figure 5 includes background traffic only (without the proposed project) and Figure 6 includes the additional traffic anticipated to be generated by the project.

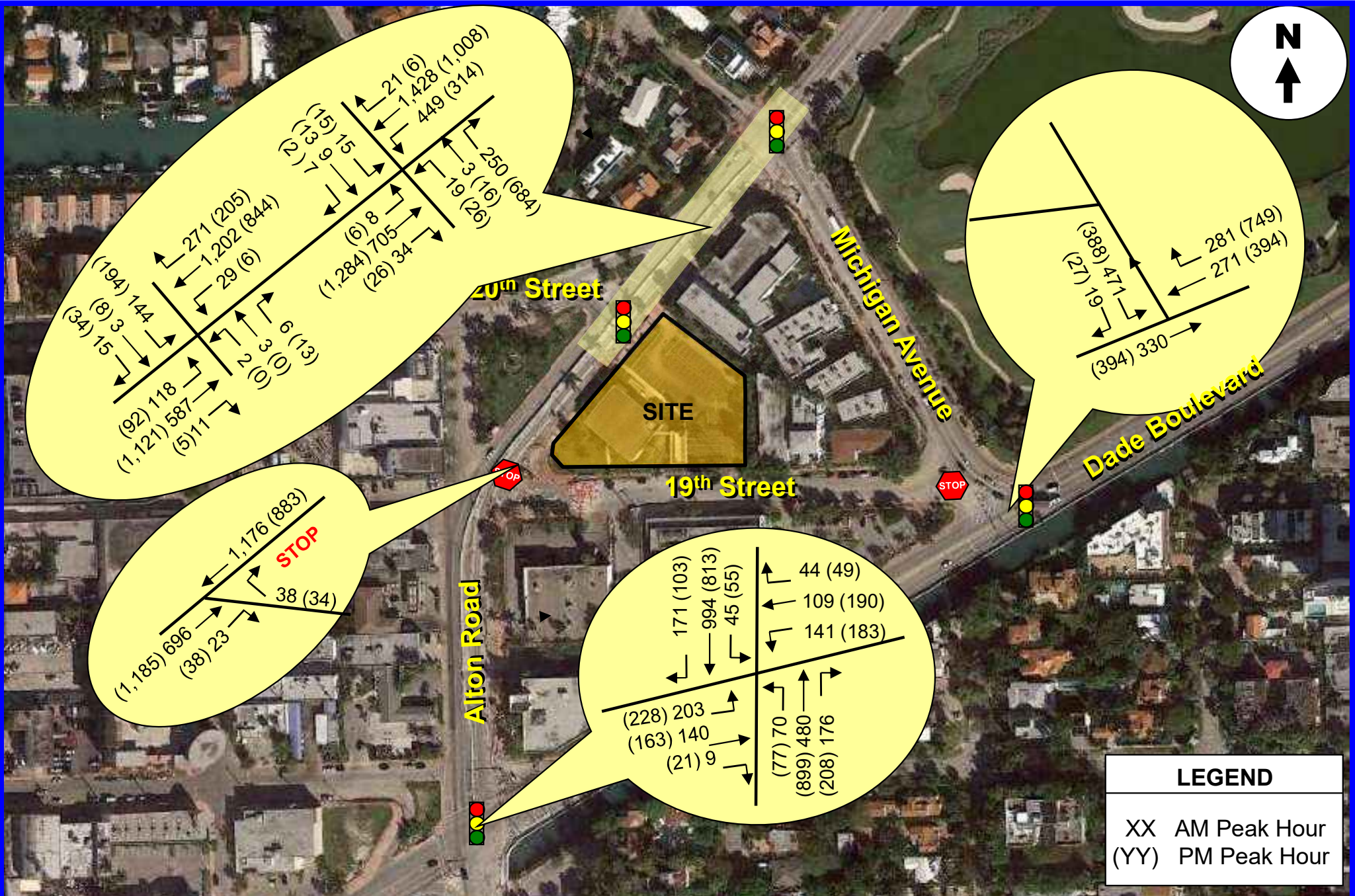

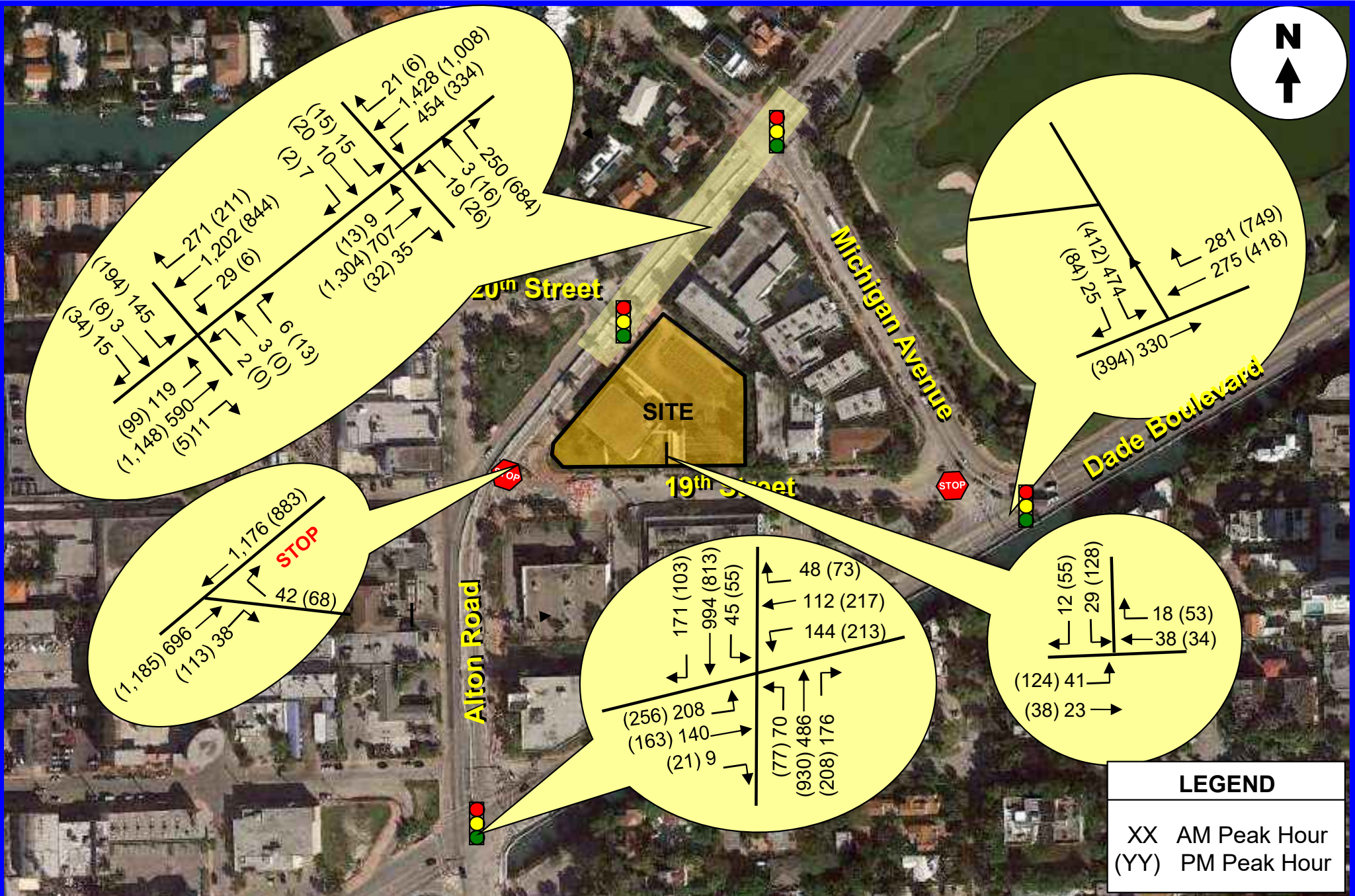

Level of Service Analyses

Intersection capacity/level of service analyses were conducted for the six study intersections. The analyses were undertaken following the capacity/level of service procedures outlined in the Highway Capacity Manual (HCM) 6th Edition using the SYNCHRO software. The results of the capacity analyses are summarized in Tables 3A and 3B.

TABLE 3A AM Peak Hour Intersection Capacity Analysis 1901 Alton Road						
Intersection	Scenario	Overall LOS/ Delay (sec)	Approach Delay			
			EB	WB	NB	SB
101: Alton Rd & N Michigan Ave	Existing	B/17.9	E/68.3	E/67.5	A/1.9	C/22.7
	Background	B/18.4	E/68.4	E/67.5	A/2.1	C/23.5
	Future	B/18.6	E/68.5	E/67.5	A/2.2	C/23.7
102: Alton Rd & 20 St/Sunset Harbour Dr	Existing	B/15.8	E/70.6	E/72.1	A/6.3	B/13.9
	Background	B/18.0	E/70.5	E/72.1	A/7.3	B/17.1
	Future	B/17.2	E/70.8	E/72.1	A/7.3	B/15.8
103: Alton Rd & 19 St	Existing			A/9.2		
	Background			A/9.4		
	Future			A/9.4		
104: Alton Rd & Dade Blvd	Existing	C/28.1	E/72.7	E/58.4	B/14.3	B/17.5
	Background	C/29.8	E/78.5	E/58.6	B/15.5	B/18.7
	Future	C/30.5	F/82.1	E/58.9	B/15.6	B/18.7
	Future + Opt	C/29.9	E/76.9	E/60.4	B/15.6	B/18.5
105: Dade Blvd & Michigan Ave	Existing	B/19.8	A/6.9	A/3.7		D/46.5
	Background	B/19.7	A/7.7	A/4.1		D/45.3
	Future	B/19.7	A/7.8	A/4.2		D/44.8
19 St & Driveway	Existing					
	Background					
	Future					A/8.7

Source: Highway Capacity Manual 6th Edition and HCM 2000

TABLE 3B PM Peak Hour Intersection Capacity Analysis 1901 Alton Road						
Intersection	Scenario	Overall LOS/ Delay (sec)	Approach Delay			
			EB	WB	NB	SB
101: Alton Rd & N Michigan Ave	Existing	B/13.4	E/65.8	E/66.5	A/2.1	C/21.6
	Background	B/13.6	E/65.8	E/66.7	A/2.6	C/21.6
	Future	B/14.3	E/66.2	E/66.6	A/3.3	C/22.4
102: Alton Rd & 20 St/Sunset Harbour Dr	Existing	B/15.0	E/70.9	E/71.0	A/7.7	B/11.0
	Background	B/16.2	E/71.1	E/71.0	A/8.6	B/12.0
	Future	B/15.6	E/71.1	E/71.0	A/8.8	B/10.7
103: Alton Rd & 19 St	Existing			B/10.3		
	Background			B/10.6		
	Future			B/11.2		
104: Alton Rd & Dade Blvd	Existing	C/33.8	F/80.8	E/58.4	C/22.0	B/19.6
	Background	D/37.6	F/96.6	E/60.7	C/24.8	C/20.7
	Future	D/45.0	F/133.4	E/69.0	C/25.4	C/20.7
	Future + Opt	D/39.5	F/80.0	E/60.8	C/29.9	C/24.6
105: Dade Blvd & Michigan Ave	Existing	B/12.6	A/5.8	A/2.8		D/46.0
	Background	B/12.6	A/6.6	A/3.1		D/44.4
	Future	B/13.6	A/7.1	A/3.4		D/42.7
19 St & Driveway	Existing					
	Background					
	Future					B/10.7

Source: Highway Capacity Manual 6th Edition and HCM 2000

As indicated in Tables 3A and 3B, all study intersections are currently operating adequately and will continue to operate at a good level of service in the year 2026 with the proposed project in place, except for one intersection.

The exception is the intersection of Alton Road and Dade Boulevard. This intersection is projected to fail under future conditions with the proposed project in place. However, with the implementation of minor signal timing improvements, the delay and LOS are expected to improve.

The proposed driveway was also evaluated, and the results show adequate operating conditions (refer to SYNCHRO analyses at the end of Appendix E).

Table 3C summarizes the 95th percentile vehicle queues for the turn lanes at the intersections affected by the project. The table includes the existing turn lane storage and

the 95th percentile vehicle queue for each scenario. The computer printouts of the intersection capacity analyses are contained in Appendix E.

TABLE 3C 95th Percentile Queue (ft)				
Alton Road & Michigan Avenue		Movement	SWBL	
		Storage (ft)	265	
	Existing	AM	261	
		PM	187	
	Background	AM	279	
		PM	201	
	Future	AM	282	
		PM	210	
	Is 95th Queue Ok?		No	
	Mitigation		(1)	
Alton Road & 20th Street		Movement	EBL	
		Storage (ft)	280	
	Existing	AM	127	
		PM	154	
	Background	AM	138	
		PM	168	
	Future	AM	138	
		PM	168	
	Is 95th Queue Ok?		Yes	
	Mitigation		No	
Alton Road & Dade Boulevard		Movement	WBR	
		Storage (ft)	60	
	Existing	AM	0	
		PM	0	
	Background	AM	0	
		PM	0	
	Future	AM	0	
		PM	28	
	Is 95th Queue Ok?		Yes	
	Mitigation		No	

Notes:

95th percentile volume exceeds capacity, queue may be longer.

Turn lanes affected by project trips

(1) Future background queues without the project trips are expected to extend beyond the storage bay. The project increases the queue by 17 ft or one vehicle.

Note that the SWL queue at the intersection of Alton Road and Michigan Avenue extend beyond the length of the existing storage bay during the AM background condition scenario without the project traffic in place. The impact of the project trips on this queue is 17 ft or less than one vehicle. Therefore, mitigation is not provided.

Parking Analysis

Table 4 provides a summary of the required and provided parking spaces for each of the proposed land uses. As shown in Table 4, a total of 165 spaces are provided and the proposed development is to provide a total of 277 spaces. Please refer to the site plan sheet No 1 for more details.

Table 4 – Parking Summary

PARKING REQUIREMENTS				
SPACE	REQUIRED	GROSS AREA/ SEATS	FACTOR	PARKING SPACES
GROCERY STORE	1 SPACE / 250 SF	34,953	250	140
CAFÉ (WITHIN STORE)	1 SPACE / 4 SEATS	60	4	15
BANK	1 SPACE / 400 SF	3,908	400	10
				TOTAL 165
				PROVIDED 277
				EXCESS -112

Maneuverability Analysis

A maneuverability analysis was conducted for passenger vehicles at the entrance into and out of the parking garage, loading areas, and garbage collection trucks using the AutoTURN software. The AutoTURN exhibits are included in Appendix F.

MULTIMODAL EVALUATION

Sidewalks are provided on both sides of Alton Road, Michigan Avenue, 20th Street and 19th Street. The width of the sidewalk along Alton Road is nine (9) feet and along 19th Street it is five (5) feet.

Safe pedestrian features (ramps, pedestrian signals with push buttons) are provided at the signalized intersections of Alton Road and Michigan Avenue, Alton Road and 20th Street, Alton Road and Dade Boulevard, and Michigan Avenue and Dade Boulevard. Miami Dade Transit routes 115, middle beach loop, and south beach loop travel north and south along Alton Road and Dade Boulevard. Bus stops are located along Alton Road and Dade Boulevard. A Citi Bike station is located on 19th Street, approximately 200 feet from the 1901 Alton project (south side of 19th Street near Dade Boulevard). Additionally, the project is providing bicycle racks along Alton Road (for 80 bicycles).

TRANSPORTATION DEMAND MANAGEMENT

Traf Tech Engineering, Inc. prepared a Transportation Demand Management (TDM) plan for the 1901 Alton Road project. Travel Demand Management plans (TDM) establish policies and mechanisms to reduce automobile trips to and from designated facilities. TDM plans usually use several approaches to address all modes of transportation likely to be used to provide access to a facility such as single occupant driving, carpooling, transit, bicycling and walking. The goal of TDM plans is to increase the use of alternatives modes to single occupant driving, i.e., to reduce the number of automobile trips to and from the facility and consequently, minimizing automobile traffic impacts on the street system.

Successful TDM plans not only address all modes of transportation, but also use policies such as inducements for alternative modes (subsidies), physical enhancements (bike lockers, preferential parking for carpools) and disincentives for automobile use (no free parking for employees).

Potential measures for each mode are addressed below. Use of an employee transportation subsidy is also presented.

Pedestrian Access

Walking not only reduces automobile trips and their contribution to congestion and emissions, it also provides health benefits to the employees who use this mode of transportation. It is, however, the mode that is least likely to be used for a number of reasons. It is unlikely that employees of the commercial building use will reside within a reasonable walking distance (within ¼ - ½ mile) of the subject facility. However, the area near the subject project is a high pedestrian traffic area and therefore, many bank customers and future grocery shoppers of the 1901 Alton Road project are expected to be walking trips. Sidewalks exist on both sides of Alton Road and 19th Street, as well as safe pedestrian crosswalks (with ramps and pedestrian signals) at the adjacent and nearby signalized intersections of Alton Road & Dade Boulevard, Alton Road and 20th Street,

Alton Road & Michigan Avenue, and Dade Boulevard & Michigan Avenue. The sidewalk width along Alton Road is nine (9) feet and along 19th Street it is five (5) feet.

Bicycling

The site of the 1901 Alton Road project offers two potential approaches to encourage cycling, the use of the Citi Bike program and use of grocery store employee-owned bicycles. Additionally, use of Citi Bike could be supported by providing monthly passes to employees. Monthly passes are \$15.00 for unlimited 30-minute rides and \$25.00 for unlimited 60-minute rides. Within the immediate area of the project, there is one (1) convenient Citi Bike rental station (located on the southwest corner of 20th Street and Sunset Drive). Future customers and employees could be informed of this Citi Bike Station. This station has sixteen (16) bicycle rental bicycles.

(Goal: Offer 2 free City Bike passes to retail employees. Integrate bikeshare information into communication materials for future residents and visitors).

Mass Transit

There are several transit options for the 1901 Alton Road development. These transit options include Routes 115, South Beach Loop, and Middle Beach Loop. The nearest bus stop for these services is located on Alton Road, just south of 19th Street (within 250 feet from the project site). These transit routes provide frequent service and access to all of Miami-Dade County as well as connections to other destinations outside of the County. Employers of the grocery store can provide a significant inducement to employees to use public transportation (Miami-Dade Transit, MDT) through a transit subsidy. Transit subsidies can also provide tax benefits to both employees and employers.

MDT offers three methods to provide transit subsidies:

The employee uses pre-tax dollars from their salary to purchase monthly transit passes. There is no income tax on the portion of their salary used for transit passes. The pre-tax funds also reduce the employees' taxable salary, reducing the total amount of income tax paid by the employees. The employer pays the total cost of a monthly transit pass using a tax-deductible (to the employer) subsidy. The employer receives a tax deduction equivalent to the value of the transit subsidies provided to the employees. The transit subsidy is a fringe benefit to employees and is not taxable income.

Both the employer and employees share the cost of transit passes, paying for them with pre-tax dollars. The employer reduces his/her payroll taxes. Employees do not pay income tax on the money used for transit passes.

MDT monthly passes if purchased by an individual are \$112.50. Corporate discounts are available based on the number of participating employees. For 4 – 99 employees, monthly passes are \$101.25 per employee, for 100 or more employees, the cost is \$95.65 per employee.

Goal: Offer 2 free transit passes to retail employees. Provide bus schedule information on the lobby of the grocery store.

CONCLUSIONS AND RECOMMENDATIONS

1901 Alton is a proposed development planned to be located at 1901 Alton Road in the City of Miami Beach in Miami-Dade County, Florida. The site will be developed with the following land use and intensity:

- 34,953 square foot Supermarket
- 3,908 square foot Drive-in Bank

Access to the site is provided via a full access driveway off 19th Street. The conclusions and recommendations of the traffic study are presented below:

- The proposed project is anticipated to generate approximately 2,286 new daily trips, approximately 35 AM peak hour trips (22 inbound and 13 outbound) and approximately 223 trips during the typical afternoon peak hour (108 inbound and 115 outbound).

As indicated in Table 1, the proposed project is anticipated to generate approximately

- All study intersections are currently operating adequately and will continue to operate at a good level of service in the year 2026 with the proposed project in place, except for one intersection. The exception is the intersection of Alton Road and Dade Boulevard. This intersection is projected to fail under future conditions with the proposed project in place. However, with the implementation of minor signal timing improvements, the delay and LOS are expected to improve.
- The proposed driveway was also evaluated, and the results show adequate operating conditions.

APPENDIX A

Site Plan – 1901 Alton

DESIGN REVIEW BOARD
1901 ALTON ROAD

FINAL SUBMITTAL
10/09/2023

FILE NO. DRB23-0956

COMMERCIAL PROJECT
1901 ALTON ROAD MIAMI BEACH, FLORIDA, 33139
SCOPE OF WORK: NEW CONSTRUCTION OF 4 STORY BUILDING WITH GROUND FLOOR RETAIL AND 3 LEVELS OF PARKING



OPPENHEIM
ARCHITECTURE



7500 NE 4th Court
Suite 102
Miami, FL 33138
T: (305) 573-2728

PROJECT NUMBER

2314

PROJECT NAME

WHOLE FOODS
AND
WELLS FARGO
1901 ALTON ROAD
MIAMI BEACH, FL 33141

OWNER

CRESCENT HEIGHTS

FACADE ARCHITECT

OPPENHEIM ARCHITECTURE
AND DESIGN

DRAWING

COVER-DRB



Digitally signed by
Jennifer McConney
DN: c=US, o=STUDIO
MCG+G
ARCHITECTURE,
dnQualifier=401410
D00000186945F530E
0000E32D,
231 Jennifer
McConney
Date: 2023.10.06
16:00:59 -04'00'

JENNIFER MCCONNEY FLORIDA LIC# 160059

ALL DRAWINGS AND WRITTEN MATERIAL APPEARING
HEREIN CONSTITUTE THE ORIGINAL AND UNPUBLISHED
WORK OF STUDIO MCG+G ARCHITECTURE AND
MAY NOT BE DUPLICATED, COPIED OR DISCLOSED
WITHOUT THE EXPRESS WRITTEN CONSENT OF
STUDIO MCG+G ARCHITECTURE & PLANNING, INC. © 2023

SCALE:

DRAWN: CV, JDB

CHECK: JMcG

DATE: 10/09/23

SHEET NUMBER

A0.00

MIAMI BEACH

Planning Department, 1700 Convention Center Drive
Miami Beach, Florida 33139, www.miamibeachfl.gov
305.673.7550

ZONING DATA SHEET



7500 NE 4th Court
Suite 102
Miami, FL 33138
T: (305) 573-2728

PROJECT NUMBER

2314

PROJECT NAME

**WHOLE FOODS
AND
WELLS FARGO**
1901 ALTON ROAD
MIAMI BEACH, FL 33141

OWNER

CRESCENT HEIGHTS

FACADE ARCHITECT

OPPENHEIM ARCHITECTURE
AND DESIGN

DRAWING

**INDEX OF
DRAWINGS
AND SITE
DATA**

JENNIFER MCCONNEY FLORIDA LIC# AR93044

ALL DRAWINGS AND WRITTEN MATERIAL APPEARING
HEREIN CONSTITUTE THE ORIGINAL AND UNPUBLISHED
WORK OF STUDIO MCG ARCHITECTURE AND
MAY NOT BE DUPLICATED, USED OR DISCLOSED
WITHOUT THE EXPRESS WRITTEN CONSENT OF
STUDIO MCG ARCHITECTURE & PLANNING, INC. (c) 2020

SCALE: 1/4" = 1'-0"

DRAWN: CV, JDB

CHECK: JMcG

DATE: 10/09/23

SHEET NUMBER

A0.01

INDEX OF DRAWINGS

SHEET #	DESCRIPTION	SUBM1	SUBM2	SUBM3
	SURVEY		•	
A0.00-PB	COVER-PB		•	
A0.01	INDEX OF DRAWINGS AND SITE DATA		•	
A0.02	GROSS AREA DIAGRAMS		•	
A0.03	FAR DIAGRAMS		•	
A0.04	RENDERING VIEW OF SOUTH AND ALTON RD FACADES		•	
A0.07	AERIAL VIEWS		•	
A0.08	EXISTING PHOTOGRAPHY		•	
A0.09	EXISTING PHOTOGRAPHY		•	
A0.10	EXISTING PHOTOGRAPHY		•	
A0.11	EXISTING PHOTOGRAPHY		•	
A0.12	EXISTING PHOTOGRAPHY		•	
A0.13	EXISTING PHOTOGRAPHY		•	
A0.14	EXISTING PHOTOGRAPHY		•	
A0.14.1	EXISTING PHOTOGRAPHY		•	
A0.15	SITE ELEVATIONS		•	
A0.16	SITE ELEVATIONS		•	
A0.17	EXPLODED AXONOMETRIC DIAGRAM		•	
A1.00	SITE PLAN		•	
A1.01	LEVEL 1 FLOOR PLAN		•	
A1.02	LEVEL 1.5 FLOOR PLAN		•	
A1.03	LEVEL 2 FLOOR PLAN		•	
A1.04	LEVEL 3 FLOOR PLAN		•	
A1.05	LEVEL 4 FLOOR PLAN AND ROOF PLAN		•	
A1.06	LOADING DOCK DIAGRAMS		•	
A1.07	DEMO FLOOR PLAN		•	
A2.01	BUILDING ELEVATIONS		•	
A2.02	BUILDING ELEVATIONS		•	
A2.03	BUILDING SECTIONS		•	
A2.10	WALL SECTION		•	
A2.11	WALL SECTION		•	
A2.12	WALL SECTION		•	

ITEM #	Zoning Information	LAND USE: CD-2
1	Address:	1901 Alton Rd, Miami Beach, FL 33139
2	Board and File numbers:	
3	Folio number(s):	02-3234-001-0030
4	Year constructed:	1986
5	Base Flood Elevation:	8'-0" NGVD
		(road elevation to be raised in 2025 per City of Miami Beach)
6	Adjusted grade (Flood+Grade/2)	8'-0"
7	Lot Width	N/A
8	Minimum Unit Size	N/A
9	Existing User	WELLS FARGO
	Proposed Use:	GROCERY STORE MAIN USE, BANK ACCESSORY USE

		Maximum	Existing	Proposed	Deficiencies
10	Height	45'-0"		43'-0"	-
11	Number of Stories	N/A	1	4	-
12	FAR	1	0.00	0.94	-
13	FLOOR AREA Square Footage	55,377 SF	0 SF	52,100 SF	-
14	GROSS Square Footage	N/A	N/A	199,772 SF	-
15	Number of Units Residential	N/A	N/A	N/A	-
16	Number of Units Hotel	N/A	N/A	N/A	-
17	Number of Seats	N/A	N/A	N/A	-
18	Occupancy Load	N/A	N/A	SEE CHART	-

	Setbacks	Required	Existing	Proposed	Deficiencies
	Pedestal (CD-1) COMMERCIAL, LOW INTENSITY DISTRICT				
19	Front Setback (ALTON RD):	0'-0"	N/A	0' - 0"	-
20	Interior side Setback (NE):	10'-0"	N/A	10'-0"	-
21	Rear Setback (E):	10'-0"	N/A	10'-0"	-
22	Side Setback facing Street (NE 19th ST):	0'-0"	N/A	0'-0"	-

	Parking	Required	Existing	Proposed	Deficiencies
23	Parking District (DISTRICT #1) TIER 1	163		277	-
24	Total # of parking spaces required	163	N/A	277	-
25	Parking Space Dimensions	8.5' X 18'	N/A	8.5' X 18'	-
26	Parking Space Configurations (45°, 60°, 90°, Parallel)		N/A	90 DEG	-
27	ADA Spaces		N/A	12	-
28	Tandem Spaces	0	N/A	0	-
29	Drive Aisle Width	22'	N/A	22'	-
30	Valet Drop off and pick up	N/A	N/A	N/A	-
31	Loading zones and Trash collection areas	2	N/A	2	-
32	Bikes (SHORT TERM)	4	N/A	4	-
33	Bikes (LONG TERM)	15	N/A	15	-
34	loading spaces: 3 for 20-40k sf	3	N/A	3	-

35	Is this a contributing building?	NO
36	Located within a Local Historic District?	NO

PARKING REQUIREMENTS				
SPACE	REQUIRED	GROSS AREA/ SEATS	FACTOR	PARKING SPACES
GROCERY STORE	1 SPACE / 250 SF	34,953	250	140
CAFÉ (WITHIN STORE)	1 SPACE / 4 SEATS	60	4	15
BANK	1 SPACE / 400 SF	3,908	400	10
		TOTAL		165
		PROVIDED		277
		EXCESS		-112

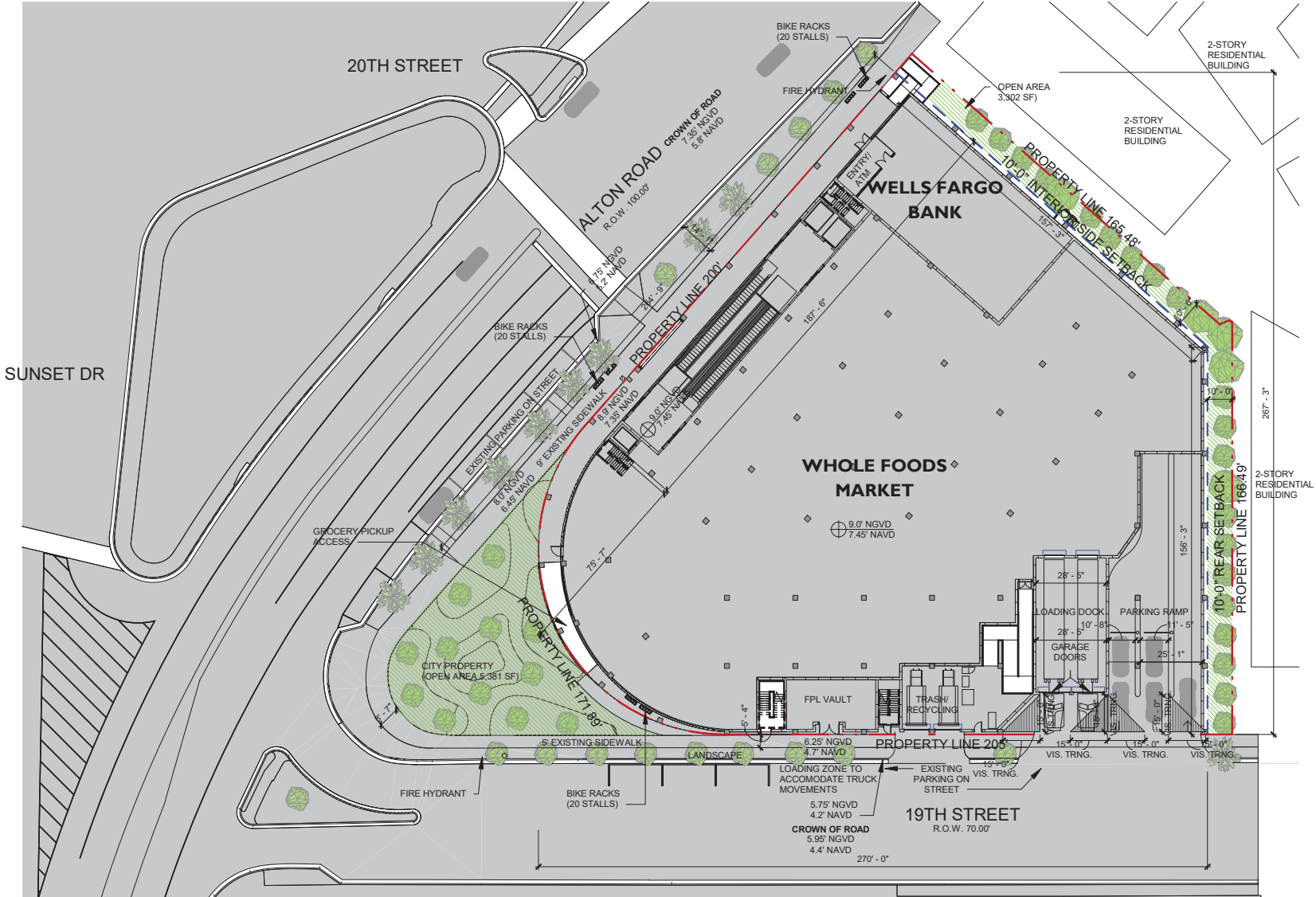

WALGREENS



SITE PLAN
1" = 40'-0"

Parking Schedule		
Level	Comments	Count
	PARKING ON STREET	3
L2 PARKING	PARKING 1 CAR TYP.	79
L2 PARKING	PARKING SINGLE ADA	4
L3 PARKING	PARKING 1 CAR TYP.	85
L3 PARKING	PARKING SINGLE ADA	6
L4 PARKING	PARKING 1 CAR TYP.	96
L4 PARKING	PARKING SINGLE ADA	4

277



APPENDIX B

Traffic Counts

Traf Tech Engineering Inc.

File Name : 1-Alton Rd & Michigan Ave
 Site Code : 00000000
 Start Date : 8/9/2023
 Page No : 1

Groups Printed- Peds & Bikes

Start Time	Alton Rd From North				Michigan Ave From East				Alton Rd From South				Michigan Ave From West				Int. Total
	Bikes			Peds	Bikes			Peds	Bikes			Peds	Bikes			Peds	
07:00	1	0	0	0	0	0	0	0	0	0	0	2	0	0	0	0	3
07:15	0	0	0	0	0	0	0	0	0	0	0	0	1	0	0	0	1
07:30	0	0	0	0	0	0	0	0	0	0	0	1	0	0	0	0	1
07:45	0	0	0	0	0	0	0	0	0	0	0	2	3	0	0	0	5
Total	1	0	0	0	0	0	0	0	0	0	0	5	4	0	0	0	10
08:00	0	0	0	0	0	0	0	0	2	0	0	0	0	0	0	0	2
08:15	0	0	0	0	2	0	0	0	0	0	0	2	9	0	0	0	13
08:30	0	0	0	0	0	0	0	0	0	0	0	0	1	0	0	0	1
08:45	0	0	0	0	3	0	0	0	0	0	0	0	0	0	0	0	3
Total	0	0	0	0	5	0	0	0	2	0	0	2	10	0	0	0	19
*** BREAK ***																	
16:00	0	0	0	0	0	0	0	0	0	0	0	3	2	0	0	0	5
16:15	0	0	0	0	1	0	0	0	0	0	0	0	0	0	0	0	1
16:30	0	0	0	1	0	0	0	0	0	0	0	1	0	0	0	1	3
16:45	0	0	0	0	26	0	0	0	0	0	0	0	0	0	0	1	27
Total	0	0	0	1	27	0	0	0	0	0	0	4	2	0	0	2	36
17:00	0	0	0	0	1	0	0	0	0	0	0	0	1	0	0	0	2
17:15	0	0	0	0	0	0	0	0	0	0	0	1	0	0	0	0	1
17:30	0	0	0	0	1	0	0	0	0	0	0	0	0	0	0	0	1
17:45	0	0	0	0	0	0	0	0	0	0	0	2	0	0	0	0	2
Total	0	0	0	0	2	0	0	0	0	0	0	3	1	0	0	0	6
Grand Total	1	0	0	1	34	0	0	0	2	0	0	14	17	0	0	2	71
Apprch %	50	0	0	50	100	0	0	0	12.5	0	0	87.5	89.5	0	0	10.5	
Total %	1.4	0	0	1.4	47.9	0	0	0	2.8	0	0	19.7	23.9	0	0	2.8	

Traf Tech Engineering Inc.

File Name : 1-Alton Rd & Michigan Ave
 Site Code : 00000000
 Start Date : 8/9/2023
 Page No : 1

Groups Printed- Autos - Heavy Vehicles

Start Time	Alton Rd From North					Michigan Ave From East					Alton Rd From South					Michigan Ave From West					Int. Total
	Right	Thru	Left	U-Turns	App. Total	Right	Thru	Left	U-Turns	App. Total	Right	Thru	Left	U-Turns	App. Total	Right	Thru	Left	U-Turns	App. Total	
07:00	2	235	59	0	296	46	0	5	0	51	5	71	0	1	77	0	0	0	0	0	424
07:15	2	284	88	0	374	37	0	1	0	38	5	91	0	0	96	2	0	2	0	4	512
07:30	2	244	62	0	308	54	0	7	0	61	1	100	1	0	102	1	0	4	0	5	476
07:45	2	304	84	0	390	37	1	3	0	41	4	98	1	0	103	0	1	4	0	5	539
Total	8	1067	293	0	1368	174	1	16	0	191	15	360	2	1	378	3	1	10	0	14	1951
08:00	5	286	81	1	373	58	1	2	0	61	7	142	2	0	151	1	2	2	0	5	590
08:15	6	313	94	0	413	55	2	5	0	62	4	151	3	1	159	2	0	1	0	3	637
08:30	5	300	100	1	406	50	0	2	0	52	8	173	1	0	182	2	2	7	0	11	651
08:45	2	348	115	0	465	55	0	8	0	63	11	150	0	0	161	1	4	3	0	8	697
Total	18	1247	390	2	1657	218	3	17	0	238	30	616	6	1	653	6	8	13	0	27	2575
*** BREAK ***																					
16:00	1	226	79	0	306	181	3	4	0	188	8	255	0	1	264	1	4	3	0	8	766
16:15	2	221	50	2	275	150	3	6	0	159	6	305	0	0	311	1	4	3	0	8	753
16:30	0	210	71	0	281	130	3	7	0	140	6	303	4	0	313	0	1	3	0	4	738
16:45	2	223	72	0	297	136	5	6	0	147	3	258	0	0	261	0	2	4	0	6	711
Total	5	880	272	2	1159	597	14	23	0	634	23	1121	4	1	1149	2	11	13	0	26	2968
17:00	1	218	64	0	283	159	2	8	0	169	8	262	0	0	270	0	4	9	0	13	735
17:15	0	212	52	0	264	151	2	8	0	161	8	269	2	0	279	0	3	7	0	10	714
17:30	1	257	50	0	308	117	2	3	0	122	7	277	0	1	285	1	3	2	0	6	721
17:45	2	264	43	0	309	101	0	6	0	107	5	212	0	0	217	0	1	1	0	2	635
Total	4	951	209	0	1164	528	6	25	0	559	28	1020	2	1	1051	1	11	19	0	31	2805
Grand Total	35	4145	1164	4	5348	1517	24	81	0	1622	96	3117	14	4	3231	12	31	55	0	98	10299
Apprch %	0.7	77.5	21.8	0.1		93.5	1.5	5	0		3	96.5	0.4	0.1		12.2	31.6	56.1	0		
Total %	0.3	40.2	11.3	0	51.9	14.7	0.2	0.8	0	15.7	0.9	30.3	0.1	0	31.4	0.1	0.3	0.5	0	1	
Autos	31	4050	1145			1496						3055									10082
% Autos	88.6	97.7	98.4	100	97.8	98.6	100	96.3	0	98.5	94.8	98	92.9	100	97.9	66.7	96.8	96.4	0	92.9	97.9
Heavy Vehicles																					
% Heavy Vehicles	11.4	2.3	1.6	0	2.2	1.4	0	3.7	0	1.5	5.2	2	7.1	0	2.1	33.3	3.2	3.6	0	7.1	2.1

Traf Tech Engineering Inc.

File Name : 1-Alton Rd & Michigan Ave

Site Code : 00000000

Start Date : 8/9/2023

Page No : 2

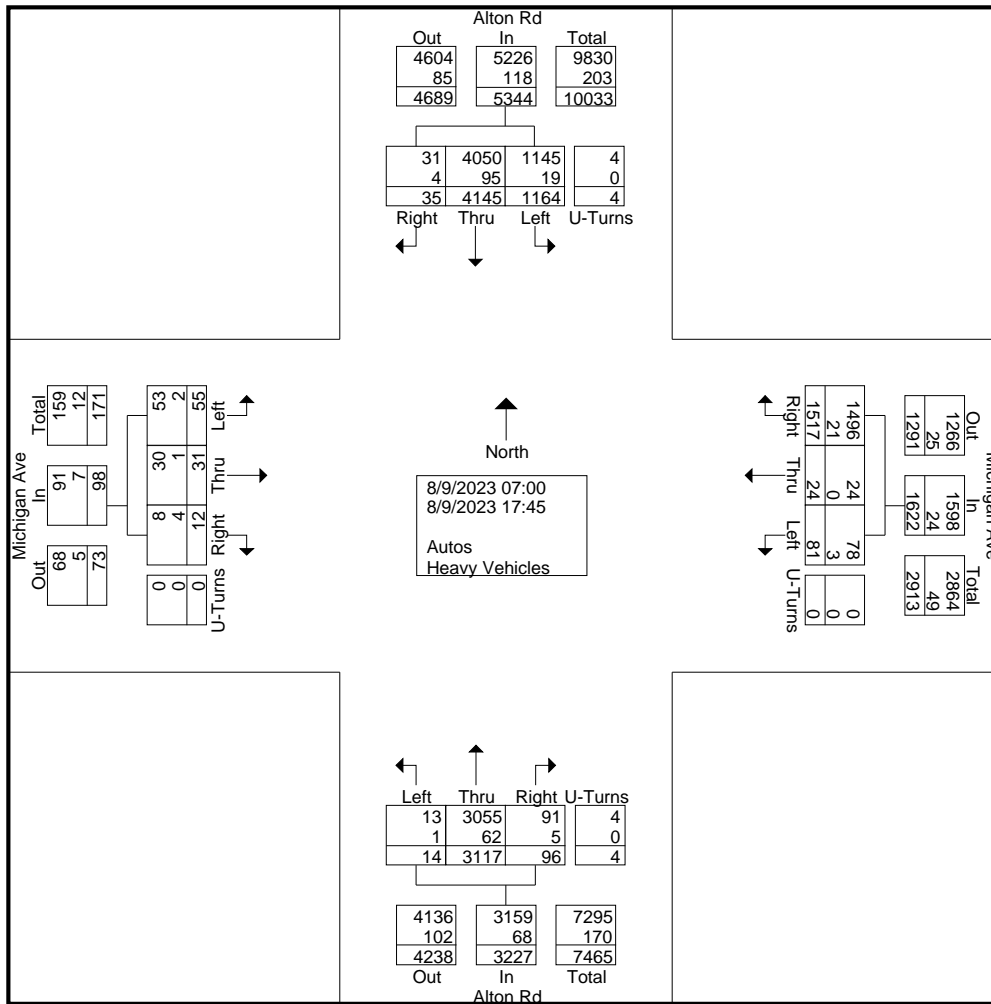

Traf Tech Engineering Inc.

File Name : 1-Alton Rd & Michigan Ave
 Site Code : 00000000
 Start Date : 8/9/2023
 Page No : 3

Start Time	Alton Rd From North					Michigan Ave From East					Alton Rd From South					Michigan Ave From West					Int. Total
	Right	Thru	Left	U-Turns	App. Total	Right	Thru	Left	U-Turns	App. Total	Right	Thru	Left	U-Turns	App. Total	Right	Thru	Left	U-Turns	App. Total	
Peak Hour Analysis From 07:00 to 17:45 - Peak 1 of 1																					
Peak Hour for Entire Intersection Begins at 16:00																					
16:00	1	226	79	0	306	181	3	4	0	188	8	255	0	1	264	1	4	3	0	8	766
16:15	2	221	50	2	275	150	3	6	0	159	6	305	0	0	311	1	4	3	0	8	753
16:30	0	210	71	0	281	130	3	7	0	140	6	303	4	0	313	0	1	3	0	4	738
16:45	2	223	72	0	297	136	5	6	0	147	3	258	0	0	261	0	2	4	0	6	711
Total Volume	5	880	272	2	1159	597	14	23	0	634	23	1121	4	1	1149	2	11	13	0	26	2968
% App. Total	0.4	75.9	23.5	0.2		94.2	2.2	3.6	0		2	97.6	0.3	0.1		7.7	42.3	50	0		
PHF	.625	.973	.861	.250	.947	.825	.700	.821	.000	.843	.719	.919	.250	.250	.918	.500	.688	.813	.000	.813	.969
Autos	3	869	272	2	1146	594	14	23	0	631	23	1109									
% Autos	60.0	98.8	100	100	98.9	99.5	100	100	0	99.5	100	98.9	100	100	99.0	50.0	100	92.3	0	92.3	99.0
Heavy Vehicles																					
% Heavy Vehicles	40.0	1.3	0	0	1.1	0.5	0	0	0	0.5	0	1.1	0	0	1.0	50.0	0	7.7	0	7.7	1.0

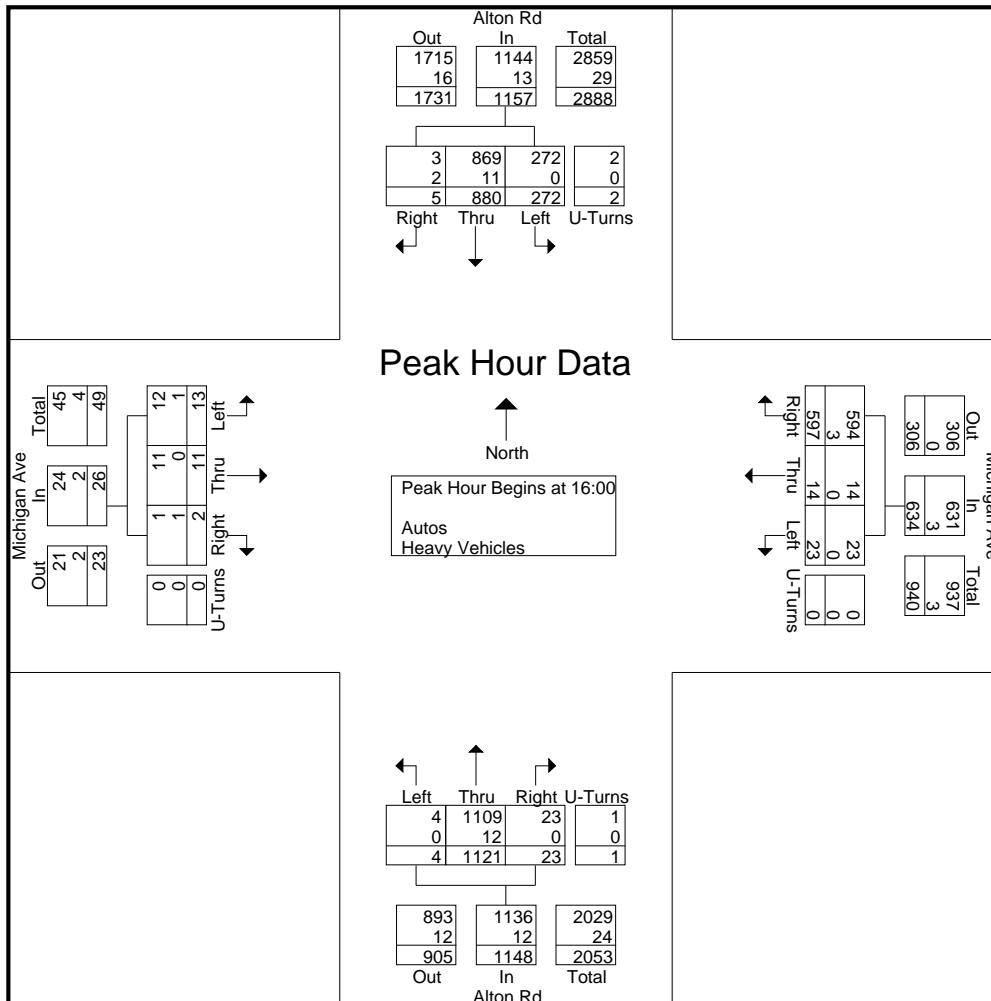

Traf Tech Engineering Inc.

File Name : 1-Alton Rd & Michigan Ave
 Site Code : 00000000
 Start Date : 8/9/2023
 Page No : 4

Start Time	Alton Rd From North					Michigan Ave From East					Alton Rd From South					Michigan Ave From West					Int. Total
	Right	Thru	Left	U-Turns	App. Total	Right	Thru	Left	U-Turns	App. Total	Right	Thru	Left	U-Turns	App. Total	Right	Thru	Left	U-Turns	App. Total	
Peak Hour Analysis From 07:00 to 08:45 - Peak 1 of 1																					
Peak Hour for Entire Intersection Begins at 08:00																					
08:00	5	286	81	1	373	58	1	2	0	61	7	142	2	0	151	1	2	2	0	5	590
08:15	6	313	94	0	413	55	2	5	0	62	4	151	3	1	159	2	0	1	0	3	637
08:30	5	300	100	1	406	50	0	2	0	52	8	173	1	0	182	2	2	7	0	11	651
08:45	2	348	115	0	465	55	0	8	0	63	11	150	0	0	161	1	4	3	0	8	697
Total Volume	18	1247	390	2	1657	218	3	17	0	238	30	616	6	1	653	6	8	13	0	27	2575
% App. Total	1.1	75.3	23.5	0.1		91.6	1.3	7.1	0		4.6	94.3	0.9	0.2		22.2	29.6	48.1	0		
PHF	.750	.896	.848	.500	.891	.940	.375	.531	.000	.944	.682	.890	.500	.250	.897	.750	.500	.464	.000	.614	.924
Autos	16	1209																			
% Autos	88.9	97.0	98.7	100	97.3	96.8	100	88.2	0	96.2	86.7	96.8	83.3	100	96.2	83.3	87.5	100	0	92.6	96.9
Heavy Vehicles																					
% Heavy Vehicles	11.1	3.0	1.3	0	2.7	3.2	0	11.8	0	3.8	13.3	3.2	16.7	0	3.8	16.7	12.5	0	0	7.4	3.1

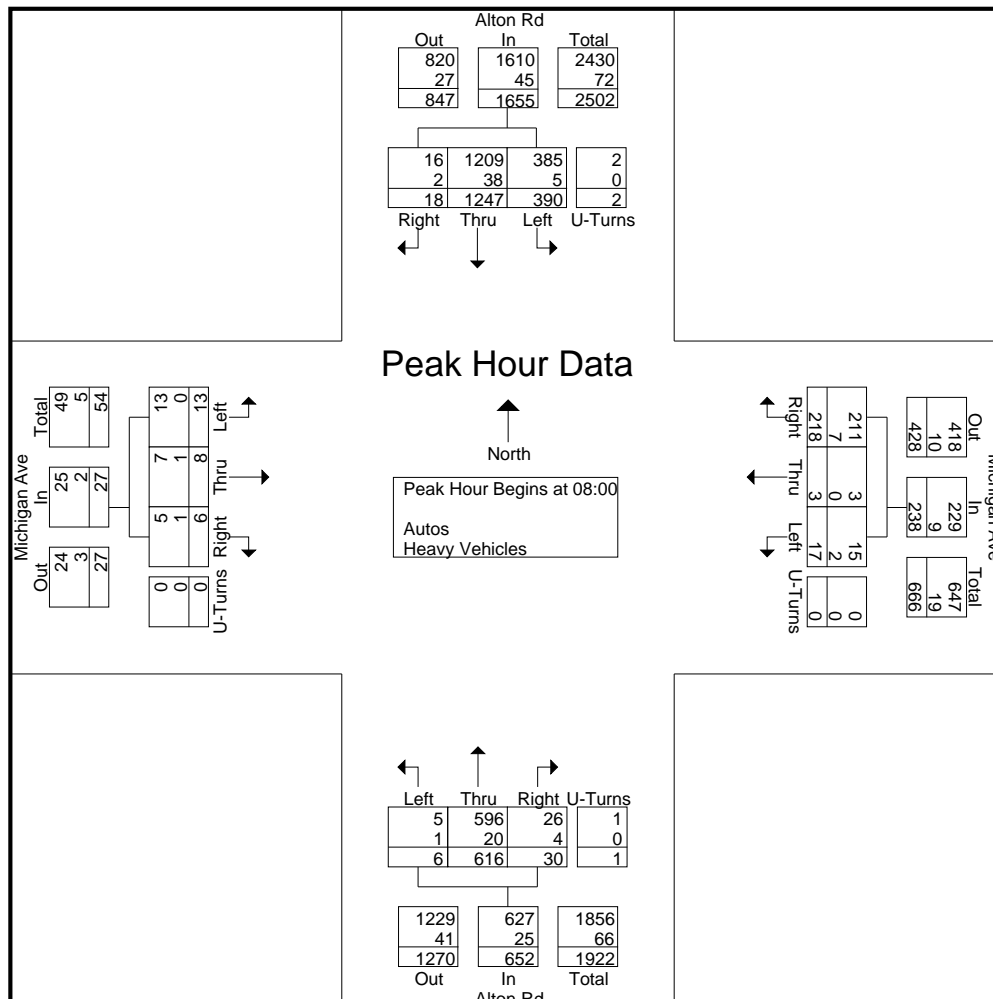

Traf Tech Engineering Inc.

File Name : 1-Alton Rd & Michigan Ave

Site Code : 00000000

Start Date : 8/9/2023

Page No : 5

Start Time	Alton Rd From North					Michigan Ave From East					Alton Rd From South					Michigan Ave From West					Int. Total
	Right	Thru	Left	U-Turns	App. Total	Right	Thru	Left	U-Turns	App. Total	Right	Thru	Left	U-Turns	App. Total	Right	Thru	Left	U-Turns	App. Total	

Peak Hour Analysis From 16:00 to 17:45 - Peak 1 of 1

Peak Hour for Entire Intersection Begins at 16:00

16:00	1	226	79	0	306	181	3	4	0	188	8	255	0	1	264	1	4	3	0	8	766
16:15	2	221	50	2	275	150	3	6	0	159	6	305	0	0	311	1	4	3	0	8	753
16:30	0	210	71	0	281	130	3	7	0	140	6	303	4	0	313	0	1	3	0	4	738
16:45	2	223	72	0	297	136	5	6	0	147	3	258	0	0	261	0	2	4	0	6	711
Total Volume	5	880	272	2	1159	597	14	23	0	634	23	1121	4	1	1149	2	11	13	0	26	2968
% App. Total	0.4	75.9	23.5	0.2		94.2	2.2	3.6	0		2	97.6	0.3	0.1		7.7	42.3	50	0		
PHF	.625	.973	.861	.250	.947	.825	.700	.821	.000	.843	.719	.919	.250	.250	.918	.500	.688	.813	.000	.813	.969
Autos	3	869	272	2	1146	594	14	23	0	631	23	1109									
% Autos	60.0	98.8	100	100	98.9	99.5	100	100	0	99.5	100	98.9	100	100	99.0	50.0	100	92.3	0	92.3	99.0
Heavy Vehicles																					
% Heavy Vehicles	40.0	1.3	0	0	1.1	0.5	0	0	0	0.5	0	1.1	0	0	1.0	50.0	0	7.7	0	7.7	1.0

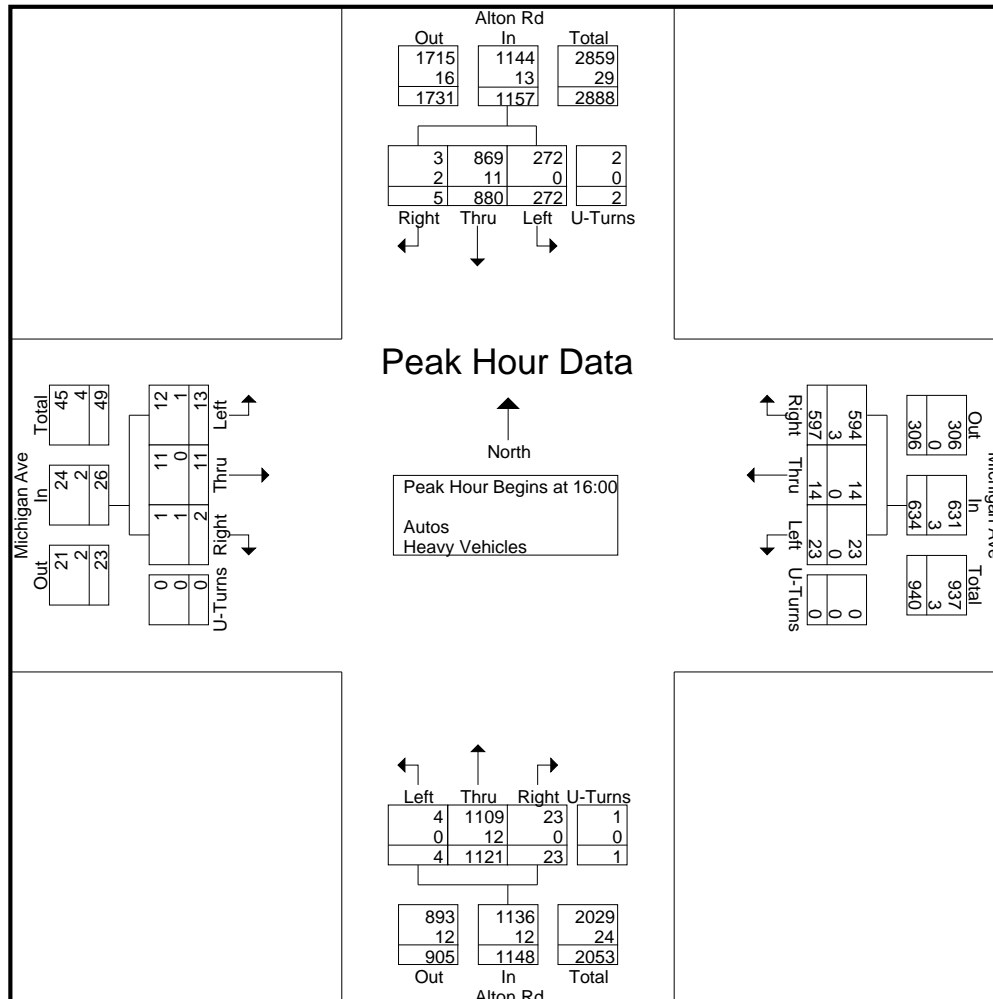

Traf Tech Engineering Inc.

File Name : 2-Alton Rd & 20th St
 Site Code : 00000000
 Start Date : 8/9/2023
 Page No : 1

Groups Printed- Peds & Bikes

Start Time	Alton Rd From North				20th Street From East				Alton Rd From South				20th Street From West				Int. Total	
	Bikes			Peds	Bikes			Peds	Bikes			Peds	Bikes			Peds		
*** BREAK ***																		
08:00	0	0	0	0	0	0	0	0	0	0	0	0	0	0	0	0	1	1
08:15	0	0	0	0	0	0	0	0	0	0	0	0	1	10	0	0	0	11
*** BREAK ***																		
Total	0	0	0	0	0	0	0	0	0	0	0	0	1	10	0	0	1	12
*** BREAK ***																		
16:00	0	0	0	0	0	0	0	0	0	0	0	3	0	0	0	0	0	3
*** BREAK ***																		
16:30	0	0	0	0	0	0	0	0	0	0	0	0	1	0	0	0	0	1
*** BREAK ***																		
Total	0	0	0	0	0	0	0	0	0	0	0	3	1	0	0	0	0	4
*** BREAK ***																		
17:15	0	0	0	0	0	0	0	0	0	1	0	0	0	0	0	0	0	1
17:30	0	0	0	1	0	0	0	0	0	0	0	0	1	0	0	0	0	2
*** BREAK ***																		
Total	0	0	0	1	0	0	0	0	0	1	0	0	1	0	0	0	0	3
Grand Total	0	0	0	1	0	0	0	0	0	1	0	0	5	11	0	0	1	19
Apprch %	0	0	0	100	0	0	0	0	16.7	0	0	83.3	91.7	0	0	0	8.3	
Total %	0	0	0	5.3	0	0	0	0	5.3	0	0	26.3	57.9	0	0	0	5.3	

Traf Tech Engineering Inc.

File Name : 2-Alton Rd & 20th St
 Site Code : 00000000
 Start Date : 8/9/2023
 Page No : 1

Groups Printed- Autos - Heavy Vehicles

Start Time	Alton Rd From North					20th Street From East					Alton Rd From South					20th Street From West					Int. Total
	Right	Thru	Left	U-Turns	App. Total	Right	Thru	Left	U-Turns	App. Total	Right	Thru	Left	U-Turns	App. Total	Right	Thru	Left	U-Turns	App. Total	
07:00	40	196	6	1	243	3	0	0	0	3	2	64	9	0	75	5	1	16	0	22	343
07:15	45	207	3	2	257	1	0	0	0	1	0	75	16	1	92	2	0	15	0	17	367
07:30	42	245	6	0	293	1	0	0	0	1	0	84	13	0	97	0	1	13	0	14	405
07:45	54	246	1	2	303	0	0	0	0	0	0	94	22	0	116	5	0	19	0	24	443
Total	181	894	16	5	1096	5	0	0	0	5	2	317	60	1	380	12	2	63	0	77	1558
08:00	50	238	2	0	290	1	1	0	0	2	3	113	19	0	135	4	1	26	0	31	458
08:15	65	257	3	0	325	1	1	0	0	2	3	124	27	0	154	2	1	27	0	30	511
08:30	50	247	10	0	307	2	1	1	0	4	1	151	21	0	173	2	0	32	0	34	518
08:45	68	308	4	6	386	1	0	1	0	2	3	125	27	1	156	5	1	41	0	47	591
Total	233	1050	19	6	1308	5	3	2	0	10	10	513	94	1	618	13	3	126	0	142	2078
*** BREAK ***																					
16:00	45	184	2	0	231	5	0	0	0	5	1	222	20	0	243	9	4	41	0	54	533
16:15	44	184	2	0	230	2	0	0	0	2	1	269	18	3	291	5	3	36	0	44	567
16:30	45	175	0	0	220	2	0	0	0	2	0	261	13	0	274	2	0	40	0	42	538
16:45	44	194	1	0	239	2	0	0	0	2	2	227	25	0	254	5	0	48	0	53	548
Total	178	737	5	0	920	11	0	0	0	11	4	979	76	3	1062	21	7	165	0	193	2186
17:00	43	181	3	0	227	3	0	0	0	3	1	195	19	0	215	4	1	47	0	52	497
17:15	44	175	1	1	221	2	0	1	0	3	0	234	19	2	255	5	5	54	0	64	543
17:30	37	227	1	1	266	7	1	1	0	9	2	220	21	0	243	6	0	45	0	51	569
17:45	38	234	1	1	274	3	0	1	0	4	0	168	10	1	179	4	1	41	0	46	503
Total	162	817	6	3	988	15	1	3	0	19	3	817	69	3	892	19	7	187	0	213	2112
Grand Total	754	3498	46	14	4312	36	4	5	0	45	19	2626	299	8	2952	65	19	541	0	625	7934
Apprch %	17.5	81.1	1.1	0.3		80	8.9	11.1	0		0.6	89	10.1	0.3		10.4	3	86.6	0		
Total %	9.5	44.1	0.6	0.2	54.3	0.5	0.1	0.1	0	0.6	0.2	33.1	3.8	0.1	37.2	0.8	0.2	6.8	0	7.9	
Autos	741	3431										2596									
% Autos	98.3	98.1	100	100	98.1	100	100	100	0	100	100	98.9	93.3	100	98.3	95.4	100	98.9	0	98.6	98.2
Heavy Vehicles																					
% Heavy Vehicles	1.7	1.9	0	0	1.9	0	0	0	0	0	0	1.1	6.7	0	1.7	4.6	0	1.1	0	1.4	1.8

Traf Tech Engineering Inc.

File Name : 2-Alton Rd & 20th St

Site Code : 00000000

Start Date : 8/9/2023

Page No : 2

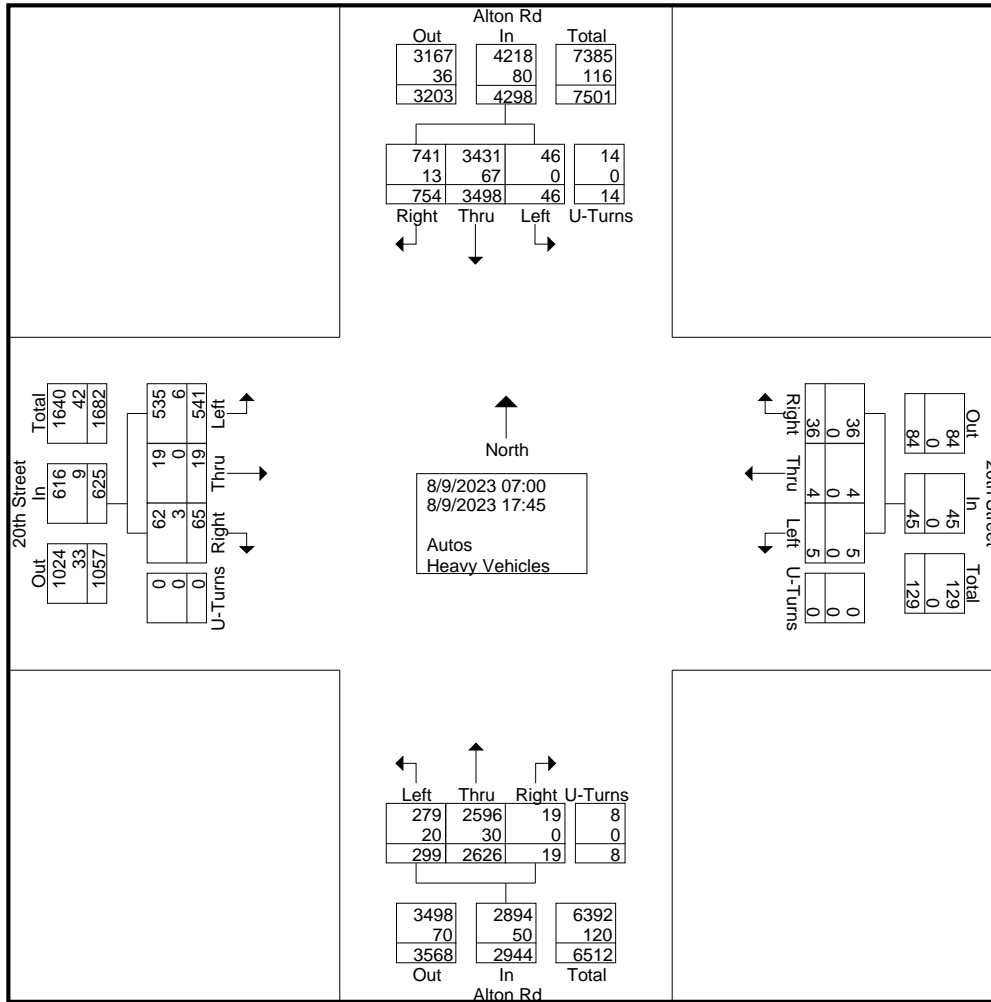

Traf Tech Engineering Inc.

File Name : 2-Alton Rd & 20th St
 Site Code : 00000000
 Start Date : 8/9/2023
 Page No : 3

Start Time	Alton Rd From North					20th Street From East					Alton Rd From South					20th Street From West					Int. Total
	Right	Thru	Left	U-Turns	App. Total	Right	Thru	Left	U-Turns	App. Total	Right	Thru	Left	U-Turns	App. Total	Right	Thru	Left	U-Turns	App. Total	
Peak Hour Analysis From 07:00 to 17:45 - Peak 1 of 1																					
Peak Hour for Entire Intersection Begins at 16:00																					
16:00	45	184	2	0	231	5	0	0	0	5	1	222	20	0	243	9	4	41	0	54	533
16:15	44	184	2	0	230	2	0	0	0	2	1	269	18	3	291	5	3	36	0	44	567
16:30	45	175	0	0	220	2	0	0	0	2	0	261	13	0	274	2	0	40	0	42	538
16:45	44	194	1	0	239	2	0	0	0	2	2	227	25	0	254	5	0	48	0	53	548
Total Volume	178	737	5	0	920	11	0	0	0	11	4	979	76	3	1062	21	7	165	0	193	2186
% App. Total	19.3	80.1	0.5	0		100	0	0	0		0.4	92.2	7.2	0.3		10.9	3.6	85.5	0		
PHF	.989	.950	.625	.000	.962	.550	.000	.000	.000	.550	.500	.910	.760	.250	.912	.583	.438	.859	.000	.894	.964
Autos	178	725	5	0	908	11	0	0	0	11	4	974	73	3	1054	21	7	163	0	191	2164
% Autos	100	98.4	100	0	98.7	100	0	0	0	100	100	99.5	96.1	100	99.2	100	100	98.8	0	99.0	99.0
Heavy Vehicles																					
% Heavy Vehicles	0	1.6	0	0	1.3	0	0	0	0	0	0	0.5	3.9	0	0.8	0	0	1.2	0	1.0	1.0

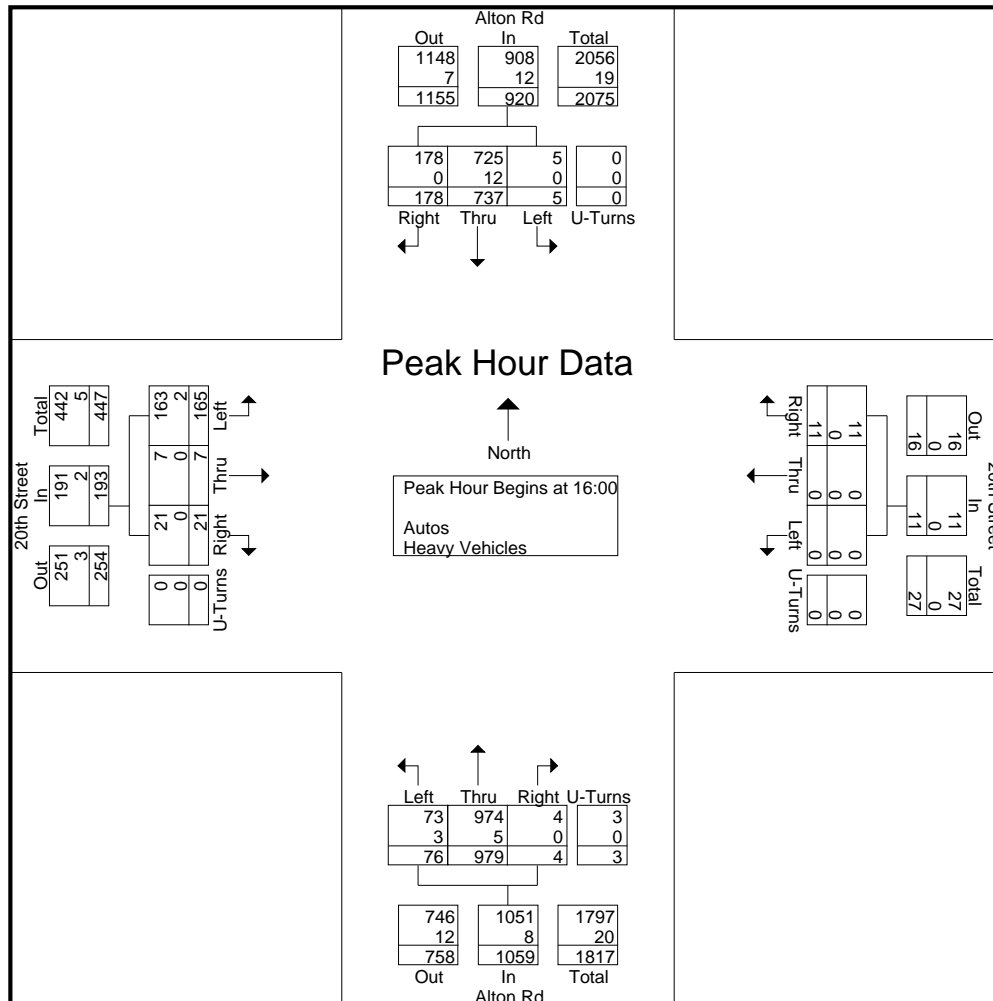

Traf Tech Engineering Inc.

File Name : 2-Alton Rd & 20th St
 Site Code : 00000000
 Start Date : 8/9/2023
 Page No : 4

Start Time	Alton Rd From North					20th Street From East					Alton Rd From South					20th Street From West					Int. Total
	Right	Thru	Left	U-Turns	App. Total	Right	Thru	Left	U-Turns	App. Total	Right	Thru	Left	U-Turns	App. Total	Right	Thru	Left	U-Turns	App. Total	
Peak Hour Analysis From 07:00 to 08:45 - Peak 1 of 1																					
Peak Hour for Entire Intersection Begins at 08:00																					
08:00	50	238	2	0	290	1	1	0	0	2	3	113	19	0	135	4	1	26	0	31	458
08:15	65	257	3	0	325	1	1	0	0	2	3	124	27	0	154	2	1	27	0	30	511
08:30	50	247	10	0	307	2	1	1	0	4	1	151	21	0	173	2	0	32	0	34	518
08:45	68	308	4	6	386	1	0	1	0	2	3	125	27	1	156	5	1	41	0	47	591
Total Volume	233	1050	19	6	1308	5	3	2	0	10	10	513	94	1	618	13	3	126	0	142	2078
% App. Total	17.8	80.3	1.5	0.5		50	30	20	0		1.6	83	15.2	0.2		9.2	2.1	88.7	0		
PHF	.857	.852	.475	.250	.847	.625	.750	.500	.000	.625	.833	.849	.870	.250	.893	.650	.750	.768	.000	.755	.879
Autos	226	1019																			
% Autos	97.0	97.0	100	100	97.1	100	100	100	0	100	100	97.7	91.5	100	96.8	84.6	100	97.6	0	96.5	97.0
Heavy Vehicles																					
% Heavy Vehicles	3.0	3.0	0	0	2.9	0	0	0	0	0	0	2.3	8.5	0	3.2	15.4	0	2.4	0	3.5	3.0

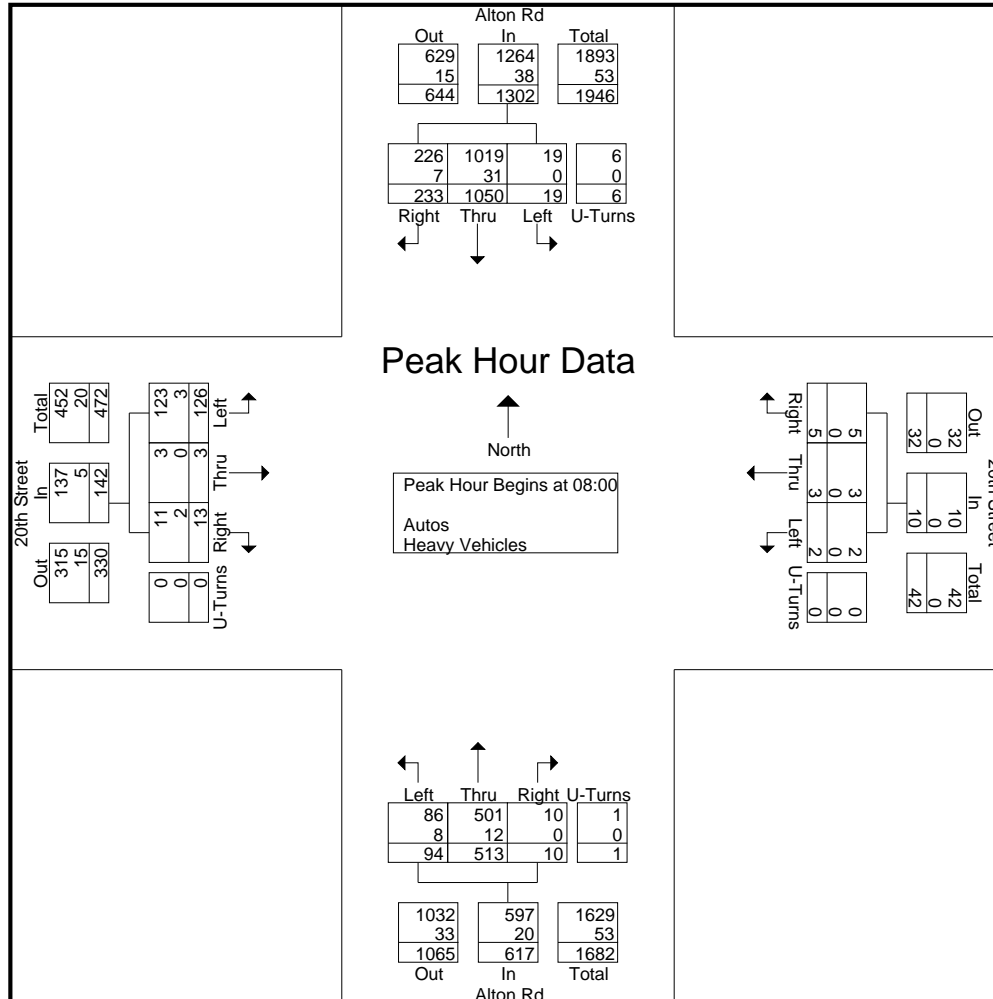

Traf Tech Engineering Inc.

File Name : 2-Alton Rd & 20th St
 Site Code : 00000000
 Start Date : 8/9/2023
 Page No : 5

Start Time	Alton Rd From North					20th Street From East					Alton Rd From South					20th Street From West					Int. Total
	Right	Thru	Left	U-Turns	App. Total	Right	Thru	Left	U-Turns	App. Total	Right	Thru	Left	U-Turns	App. Total	Right	Thru	Left	U-Turns	App. Total	
Peak Hour Analysis From 16:00 to 17:45 - Peak 1 of 1																					
Peak Hour for Entire Intersection Begins at 16:00																					
16:00	45	184	2	0	231	5	0	0	0	5	1	222	20	0	243	9	4	41	0	54	533
16:15	44	184	2	0	230	2	0	0	0	2	1	269	18	3	291	5	3	36	0	44	567
16:30	45	175	0	0	220	2	0	0	0	2	0	261	13	0	274	2	0	40	0	42	538
16:45	44	194	1	0	239	2	0	0	0	2	2	227	25	0	254	5	0	48	0	53	548
Total Volume	178	737	5	0	920	11	0	0	0	11	4	979	76	3	1062	21	7	165	0	193	2186
% App. Total	19.3	80.1	0.5	0		100	0	0	0		0.4	92.2	7.2	0.3		10.9	3.6	85.5	0		
PHF	.989	.950	.625	.000	.962	.550	.000	.000	.000	.550	.500	.910	.760	.250	.912	.583	.438	.859	.000	.894	.964
Autos	178	725	5	0	908	11	0	0	0	11	4	974	73	3	1054	21	7	163	0	191	2164
% Autos	100	98.4	100	0	98.7	100	0	0	0	100	100	99.5	96.1	100	99.2	100	100	98.8	0	99.0	99.0
Heavy Vehicles																					
% Heavy Vehicles	0	1.6	0	0	1.3	0	0	0	0	0	0	0.5	3.9	0	0.8	0	0	1.2	0	1.0	1.0

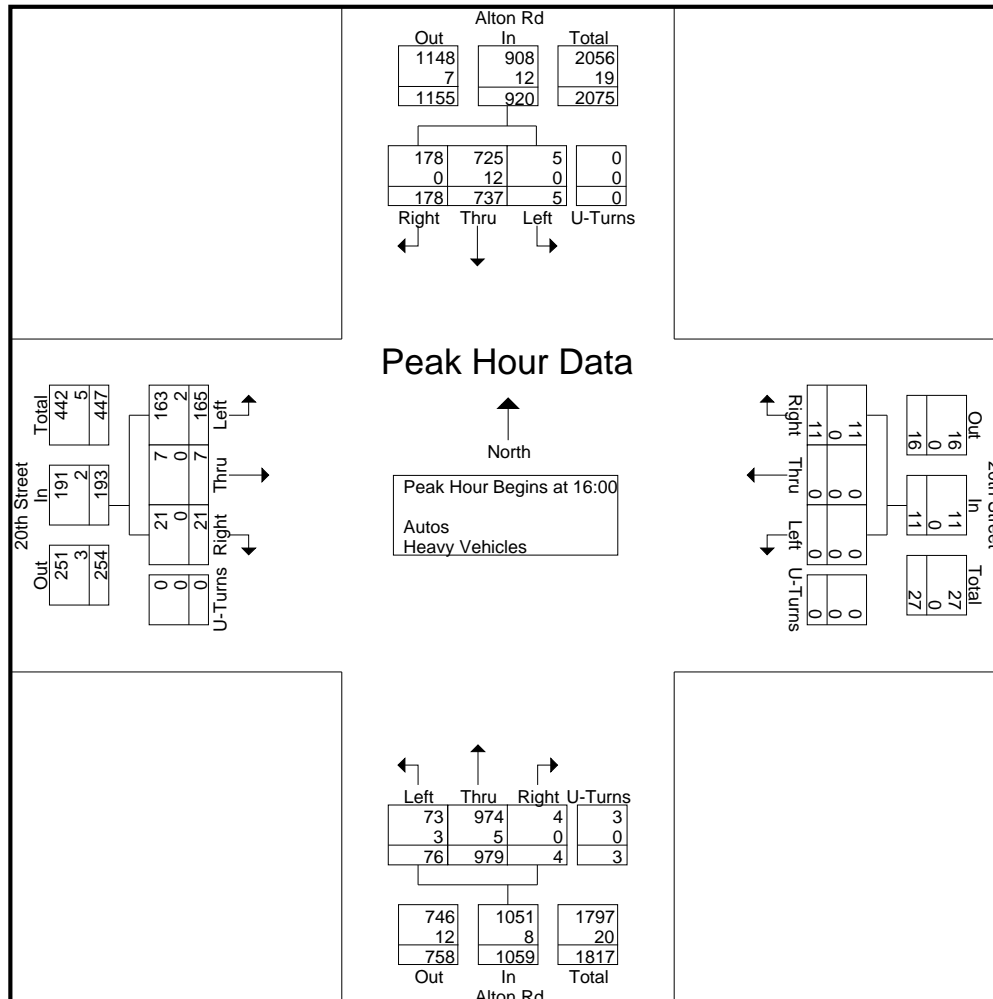

Traf Tech Engineering Inc.

File Name : 3-Alton Rd & 19th St

Site Code : 00000000

Start Date : 8/9/2023

Page No : 1

Groups Printed- Peds & Bikes

Start Time	Alton Rd From North				19th Street From East				Alton Rd From South				19th Street From West				Int. Total
	Bikes			Peds	Bikes			Peds	Bikes			Peds	Bikes			Peds	
07:00	0	0	0	1	0	0	0	0	0	0	0	0	0	0	0	0	1
07:15	0	0	0	1	0	0	0	0	0	0	0	3	0	0	0	0	4
*** BREAK ***																	
07:45	0	0	0	0	0	0	0	0	0	0	0	1	0	0	0	0	1
Total	0	0	0	2	0	0	0	0	0	0	0	4	0	0	0	0	6
08:00	0	0	0	0	0	0	0	0	0	0	0	1	0	0	0	0	1
08:15	0	0	0	0	0	0	0	0	0	0	0	3	0	0	0	0	3
08:30	0	0	0	0	0	0	0	0	0	0	0	1	0	0	0	0	1
08:45	0	0	0	1	0	0	0	0	0	0	0	1	0	0	0	0	2
Total	0	0	0	1	0	0	0	0	0	0	0	6	0	0	0	0	7
*** BREAK ***																	
16:00	0	0	0	2	0	0	0	2	1	0	0	0	0	0	0	0	5
*** BREAK ***																	
16:30	0	0	0	1	0	0	0	0	0	0	0	0	0	0	0	0	1
*** BREAK ***																	
Total	0	0	0	3	0	0	0	2	1	0	0	0	0	0	0	0	6
*** BREAK ***																	
17:15	0	0	0	0	0	0	0	0	0	0	0	1	0	0	0	0	1
*** BREAK ***																	
17:45	0	0	0	0	0	0	0	0	0	0	0	1	0	0	0	0	1
Total	0	0	0	0	0	0	0	0	0	0	0	2	0	0	0	0	2
Grand Total	0	0	0	6	0	0	0	2	1	0	0	12	0	0	0	0	21
Apprch %	0	0	0	100	0	0	0	100	7.7	0	0	92.3	0	0	0	0	
Total %	0	0	0	28.6	0	0	0	9.5	4.8	0	0	57.1	0	0	0	0	

Traf Tech Engineering Inc.

File Name : 3-Alton Rd & 19th St
 Site Code : 00000000
 Start Date : 8/9/2023
 Page No : 1

Groups Printed- Autos - Heavy Vehicles

Start Time	Alton Rd From North					19th Street From East					Alton Rd From South					19th Street From West					Int. Total
	Right	Thru	Left	U-Turns	App. Total	Right	Thru	Left	U-Turns	App. Total	Right	Thru	Left	U-Turns	App. Total	Right	Thru	Left	U-Turns	App. Total	
07:00	1	211	0	0	212	2	0	0	0	2	1	72	0	0	73	5	0	0	0	5	292
07:15	0	193	0	0	193	2	0	0	0	2	1	94	0	0	95	7	0	0	0	7	297
07:30	0	247	0	0	247	1	0	0	0	1	3	96	0	0	99	15	0	0	0	15	362
07:45	2	244	0	0	246	3	0	0	0	3	2	109	0	0	111	18	0	0	0	18	378
Total	3	895	0	0	898	8	0	0	0	8	7	371	0	0	378	45	0	0	0	45	1329
08:00	1	235	0	0	236	11	0	0	0	11	4	133	0	0	137	29	0	0	0	29	413
08:15	0	258	0	0	258	6	0	0	0	6	3	160	0	0	163	26	0	0	0	26	453
08:30	1	243	0	0	244	10	0	0	0	10	4	157	0	0	161	23	0	0	0	23	438
08:45	0	291	0	0	291	6	0	0	0	6	9	150	0	0	159	29	0	0	0	29	485
Total	2	1027	0	0	1029	33	0	0	0	33	20	600	0	0	620	107	0	0	0	107	1789
*** BREAK ***																					
16:00	0	196	0	0	196	7	0	0	0	7	7	247	0	0	254	22	0	0	0	22	479
16:15	0	192	0	0	192	13	0	0	0	13	11	265	0	0	276	31	0	0	0	31	512
16:30	0	177	0	0	177	4	0	0	0	4	8	272	0	0	280	31	0	0	0	31	492
16:45	0	197	0	0	197	6	0	0	0	6	7	249	0	0	256	20	0	0	0	20	479
Total	0	762	0	0	762	30	0	0	0	30	33	1033	0	0	1066	104	0	0	0	104	1962
17:00	2	181	0	0	183	7	0	0	0	7	3	210	0	0	213	30	0	0	0	30	433
17:15	0	183	0	0	183	9	0	0	0	9	4	252	0	0	256	25	0	0	0	25	473
17:30	0	231	0	0	231	10	0	0	0	10	5	239	0	0	244	18	0	0	0	18	503
17:45	1	234	0	0	235	3	0	0	0	3	4	183	0	0	187	18	0	0	0	18	443
Total	3	829	0	0	832	29	0	0	0	29	16	884	0	0	900	91	0	0	0	91	1852
Grand Total	8	3513	0	0	3521	100	0	0	0	100	76	2888	0	0	2964	347	0	0	0	347	6932
Apprch %	0.2	99.8	0	0		100	0	0	0		2.6	97.4	0	0		100	0	0	0		
Total %	0.1	50.7	0	0	50.8	1.4	0	0	0	1.4	1.1	41.7	0	0	42.8	5	0	0	0	5	
Autos	8	3428										2806									
% Autos	100	97.6	0	0	97.6	96	0	0	0	96	84.2	97.2	0	0	96.8	91.4	0	0	0	91.4	96.9
Heavy Vehicles																					
% Heavy Vehicles	0	2.4	0	0	2.4	4	0	0	0	4	15.8	2.8	0	0	3.2	8.6	0	0	0	8.6	3.1

Traf Tech Engineering Inc.

File Name : 3-Alton Rd & 19th St
 Site Code : 00000000
 Start Date : 8/9/2023
 Page No : 2

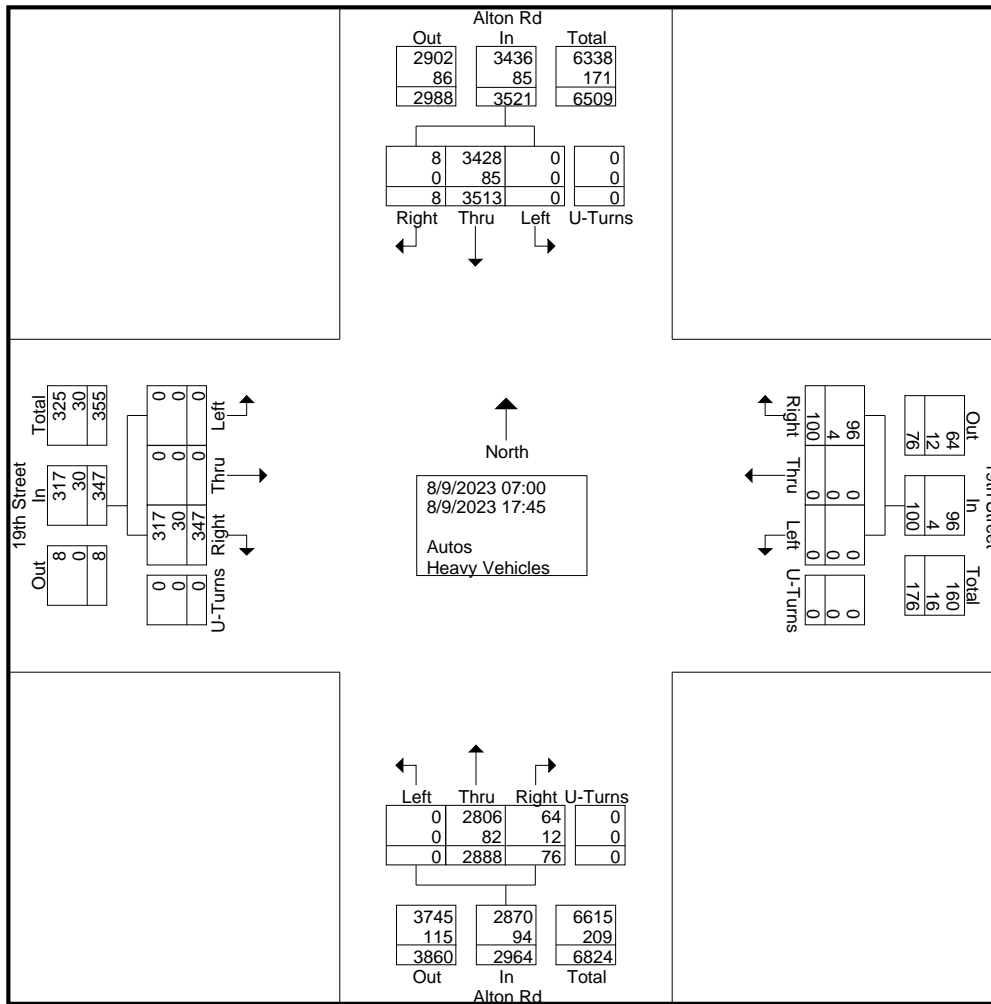

Traf Tech Engineering Inc.

File Name : 3-Alton Rd & 19th St
 Site Code : 00000000
 Start Date : 8/9/2023
 Page No : 3

Start Time	Alton Rd From North					19th Street From East					Alton Rd From South					19th Street From West					Int. Total
	Right	Thru	Left	U-Turns	App. Total	Right	Thru	Left	U-Turns	App. Total	Right	Thru	Left	U-Turns	App. Total	Right	Thru	Left	U-Turns	App. Total	
Peak Hour Analysis From 07:00 to 17:45 - Peak 1 of 1																					
Peak Hour for Entire Intersection Begins at 16:00																					
16:00	0	196	0	0	196	7	0	0	0	7	7	247	0	0	254	22	0	0	0	22	479
16:15	0	192	0	0	192	13	0	0	0	13	11	265	0	0	276	31	0	0	0	31	512
16:30	0	177	0	0	177	4	0	0	0	4	8	272	0	0	280	31	0	0	0	31	492
16:45	0	197	0	0	197	6	0	0	0	6	7	249	0	0	256	20	0	0	0	20	479
Total Volume	0	762	0	0	762	30	0	0	0	30	33	1033	0	0	1066	104	0	0	0	104	1962
% App. Total	0	100	0	0	100	100	0	0	0	100	3.1	96.9	0	0	100	100	0	0	0	100	1962
PHF	.000	.967	.000	.000	.967	.577	.000	.000	.000	.577	.750	.949	.000	.000	.952	.839	.000	.000	.000	.839	.958
Autos	0	751	0	0	751	30	0	0	0	30	30	1016	0	0	1046	94.2	0	0	0	94.2	1962
% Autos	0	98.6	0	0	98.6	100	0	0	0	100	90.9	98.4	0	0	98.1	94.2	0	0	0	94.2	98.1
Heavy Vehicles	0	1.4	0	0	1.4	0	0	0	0	0	9.1	1.6	0	0	1.9	5.8	0	0	0	5.8	1.9
% Heavy Vehicles	0	1.4	0	0	1.4	0	0	0	0	0	9.1	1.6	0	0	1.9	5.8	0	0	0	5.8	1.9

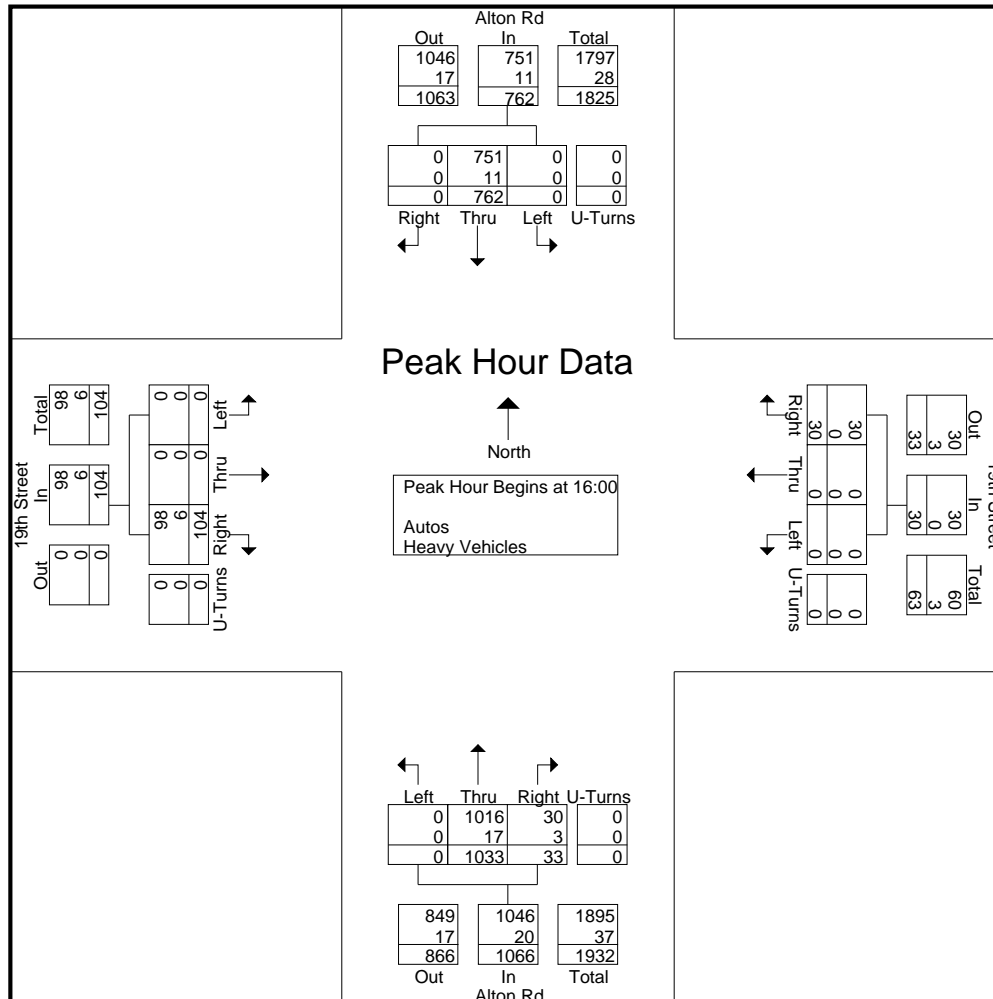

Traf Tech Engineering Inc.

File Name : 3-Alton Rd & 19th St
 Site Code : 00000000
 Start Date : 8/9/2023
 Page No : 4

Start Time	Alton Rd From North					19th Street From East					Alton Rd From South					19th Street From West					Int. Total
	Right	Thru	Left	U-Turns	App. Total	Right	Thru	Left	U-Turns	App. Total	Right	Thru	Left	U-Turns	App. Total	Right	Thru	Left	U-Turns	App. Total	
Peak Hour Analysis From 07:00 to 08:45 - Peak 1 of 1																					
Peak Hour for Entire Intersection Begins at 08:00																					
08:00	1	235	0	0	236	11	0	0	0	11	4	133	0	0	137	29	0	0	0	29	413
08:15	0	258	0	0	258	6	0	0	0	6	3	160	0	0	163	26	0	0	0	26	453
08:30	1	243	0	0	244	10	0	0	0	10	4	157	0	0	161	23	0	0	0	23	438
08:45	0	291	0	0	291	6	0	0	0	6	9	150	0	0	159	29	0	0	0	29	485
Total Volume	2	1027	0	0	1029	33	0	0	0	33	20	600	0	0	620	107	0	0	0	107	1789
% App. Total	0.2	99.8	0	0		100	0	0	0		3.2	96.8	0	0		100	0	0	0		
PHF	.500	.882	.000	.000	.884	.750	.000	.000	.000	.750	.556	.938	.000	.000	.951	.922	.000	.000	.000	.922	.922
Autos	2	991	0	0	993	31	0	0	0	31	16	574	0	0	590	95	0	0	0	95	1709
% Autos	100	96.5	0	0	96.5	93.9	0	0	0	93.9	80.0	95.7	0	0	95.2	88.8	0	0	0	88.8	95.5
Heavy Vehicles																					
% Heavy Vehicles	0	3.5	0	0	3.5	6.1	0	0	0	6.1	20.0	4.3	0	0	4.8	11.2	0	0	0	11.2	4.5

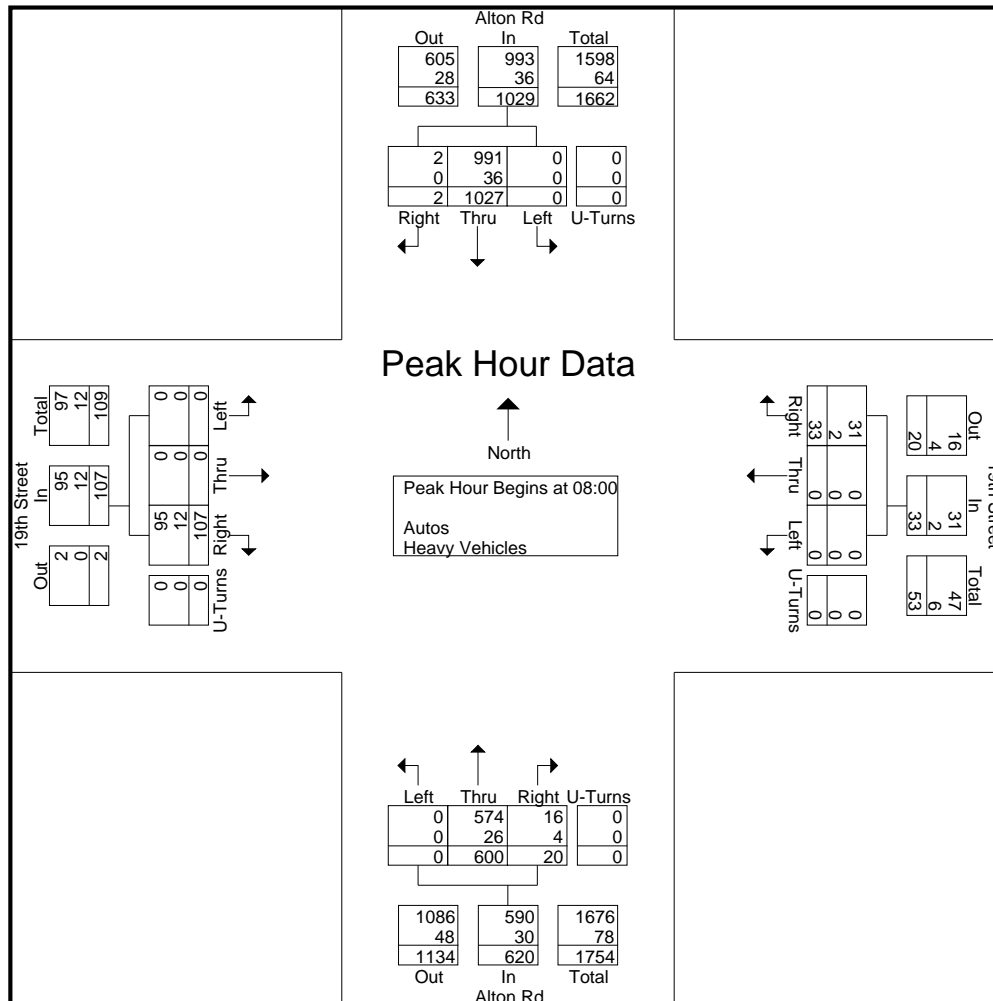

Traf Tech Engineering Inc.

File Name : 3-Alton Rd & 19th St
 Site Code : 00000000
 Start Date : 8/9/2023
 Page No : 5

Start Time	Alton Rd From North					19th Street From East					Alton Rd From South					19th Street From West					Int. Total
	Right	Thru	Left	U-Turns	App. Total	Right	Thru	Left	U-Turns	App. Total	Right	Thru	Left	U-Turns	App. Total	Right	Thru	Left	U-Turns	App. Total	

Peak Hour Analysis From 16:00 to 17:45 - Peak 1 of 1

Peak Hour for Entire Intersection Begins at 16:00

16:00	0	196	0	0	196	7	0	0	0	7	7	247	0	0	254	22	0	0	0	22	479
16:15	0	192	0	0	192	13	0	0	0	13	11	265	0	0	276	31	0	0	0	31	512
16:30	0	177	0	0	177	4	0	0	0	4	8	272	0	0	280	31	0	0	0	31	492
16:45	0	197	0	0	197	6	0	0	0	6	7	249	0	0	256	20	0	0	0	20	479
Total Volume	0	762	0	0	762	30	0	0	0	30	33	1033	0	0	1066	104	0	0	0	104	1962
% App. Total	0	100	0	0	100	100	0	0	0	100	3.1	96.9	0	0	100	100	0	0	0	100	1962
PHF	.000	.967	.000	.000	.967	.577	.000	.000	.000	.577	.750	.949	.000	.000	.952	.839	.000	.000	.000	.839	.958
Autos	0	751	0	0	751	30	0	0	0	30	30	1016	0	0	1046	104	0	0	0	104	1962
% Autos	0	98.6	0	0	98.6	100	0	0	0	100	90.9	98.4	0	0	98.1	94.2	0	0	0	94.2	98.1
Heavy Vehicles	0	1.4	0	0	1.4	0	0	0	0	0	9.1	1.6	0	0	1.9	5.8	0	0	0	5.8	1.9
% Heavy Vehicles	0	1.4	0	0	1.4	0	0	0	0	0	9.1	1.6	0	0	1.9	5.8	0	0	0	5.8	1.9

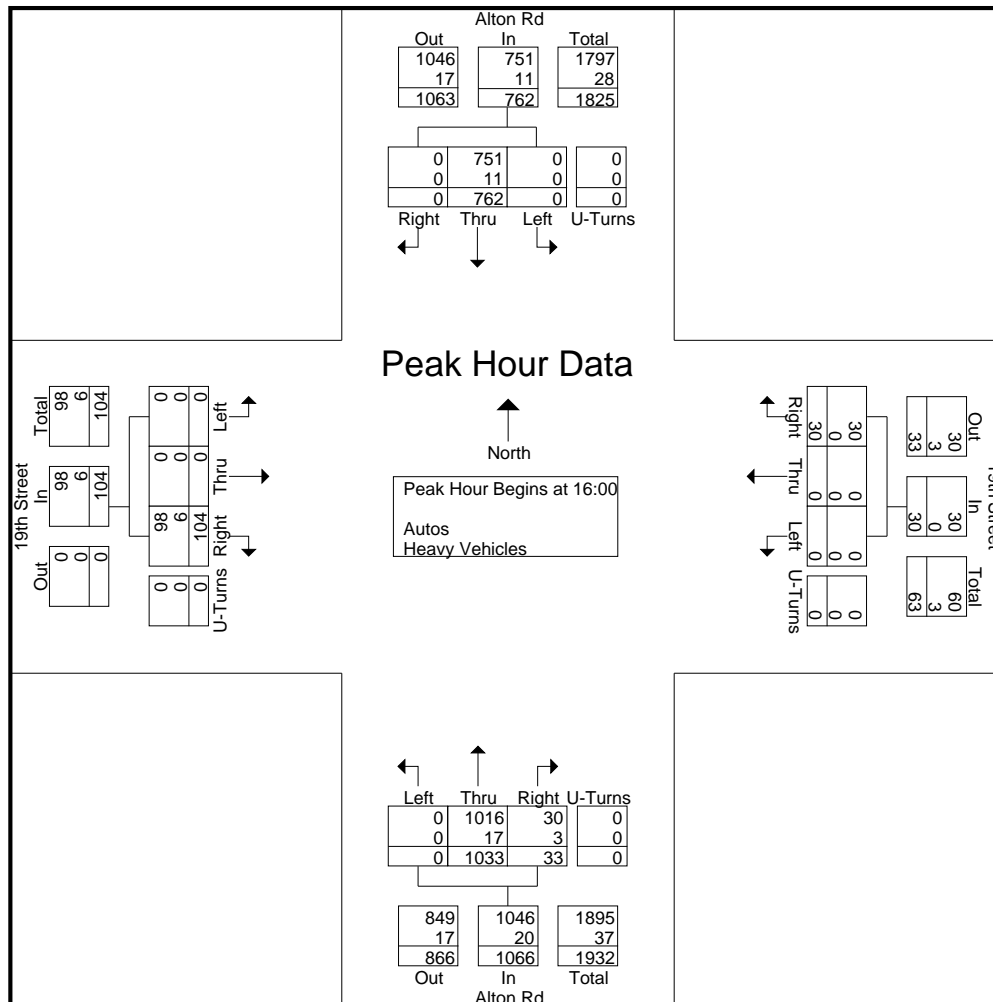

Traf Tech Engineering Inc.

File Name : 4-Alton Rd & Dade Ave
 Site Code : 00000000
 Start Date : 8/9/2023
 Page No : 1

Groups Printed- Peds & Bikes

Start Time	Alton Rd From North				Dade Ave From East				Alton Rd From South				Dade Ave From West				Int. Total
	Bikes			Peds	Bikes			Peds	Bikes			Peds	Bikes			Peds	
07:00	1	0	0	2	0	0	0	2	2	0	0	0	1	0	0	3	11
07:15	4	0	0	0	0	0	0	0	0	0	0	2	0	0	0	4	10
07:30	1	0	0	0	0	0	0	5	3	0	0	0	0	0	0	5	14
07:45	3	0	0	0	0	0	0	5	5	0	0	0	1	0	0	4	18
Total	9	0	0	2	0	0	0	12	10	0	0	2	2	0	0	16	53
08:00	4	0	0	0	1	0	0	2	11	0	0	4	2	0	0	3	27
08:15	6	0	0	0	1	0	0	5	5	0	0	0	2	0	0	2	21
08:30	0	0	0	0	0	0	0	1	4	0	0	0	0	0	0	3	8
08:45	3	0	0	2	1	0	0	6	3	0	0	2	3	0	0	0	20
Total	13	0	0	2	3	0	0	14	23	0	0	6	7	0	0	8	76
*** BREAK ***																	
16:00	3	0	0	0	1	0	0	1	1	0	0	1	2	0	0	1	10
16:15	0	0	0	0	1	0	0	8	2	0	0	0	1	0	0	9	21
16:30	0	0	0	0	0	0	0	3	4	0	0	0	1	0	0	1	9
16:45	0	0	0	0	5	0	0	1	5	0	0	0	1	0	0	3	15
Total	3	0	0	0	7	0	0	13	12	0	0	1	5	0	0	14	55
17:00	1	0	0	2	3	0	0	2	1	0	0	0	6	0	0	3	18
17:15	3	0	0	1	0	0	0	6	1	0	0	3	0	0	0	9	23
17:30	2	0	0	1	1	0	0	0	1	0	0	4	0	0	0	2	11
17:45	3	0	0	8	0	0	0	3	0	0	0	2	1	0	0	4	21
Total	9	0	0	12	4	0	0	11	3	0	0	9	7	0	0	18	73
Grand Total	34	0	0	16	14	0	0	50	48	0	0	18	21	0	0	56	257
Apprch %	68	0	0	32	21.9	0	0	78.1	72.7	0	0	27.3	27.3	0	0	72.7	
Total %	13.2	0	0	6.2	5.4	0	0	19.5	18.7	0	0	7	8.2	0	0	21.8	

Traf Tech Engineering Inc.

File Name : 4-Alton Rd & Dade Ave
 Site Code : 00000000
 Start Date : 8/9/2023
 Page No : 1

Groups Printed- Autos - Heavy Vehicles

Start Time	Alton Rd From North					Dade Ave From East					Alton Rd From South					Dade Ave From West					Int. Total
	Right	Thru	Left	U-Turns	App. Total	Right	Thru	Left	U-Turns	App. Total	Right	Thru	Left	U-Turns	App. Total	Right	Thru	Left	U-Turns	App. Total	
07:00	38	178	2	0	218	0	11	18	0	29	27	52	9	1	89	1	11	21	0	33	369
07:15	27	168	4	1	200	1	16	23	0	40	23	67	8	0	98	3	17	24	0	44	382
07:30	38	197	3	1	239	2	16	26	0	44	31	74	10	1	116	1	12	23	0	36	435
07:45	45	194	9	1	249	7	18	30	0	55	24	70	6	0	100	0	17	35	0	52	456
Total	148	737	18	3	906	10	61	97	0	168	105	263	33	2	403	5	57	103	0	165	1642
08:00	45	181	8	4	238	8	25	31	0	64	34	88	13	1	136	3	31	40	0	74	512
08:15	35	206	10	3	254	13	19	27	0	59	32	109	20	1	162	2	24	43	0	69	544
08:30	30	242	7	0	279	8	15	30	0	53	37	110	11	0	158	1	32	49	0	82	572
08:45	39	239	3	4	285	8	36	35	0	79	50	106	13	2	171	2	35	45	0	82	617
Total	149	868	28	11	1056	37	95	123	0	255	153	413	57	4	627	8	122	177	0	307	2245
*** BREAK ***																					
16:00	20	169	4	6	199	11	32	41	0	84	32	189	11	1	233	3	34	57	0	94	610
16:15	27	184	7	5	223	9	40	47	0	96	44	235	15	0	294	4	39	55	0	98	711
16:30	19	171	4	8	202	8	35	42	0	85	37	181	14	2	234	2	43	59	0	104	625
16:45	23	174	9	3	209	16	45	37	0	98	54	191	15	1	261	4	34	42	0	80	648
Total	89	698	24	22	833	44	152	167	0	363	167	796	55	4	1022	13	150	213	0	376	2594
17:00	21	174	6	4	205	10	46	34	0	90	47	176	18	2	243	8	26	43	0	77	615
17:15	25	158	5	3	191	9	41	38	0	88	38	195	14	1	248	1	36	35	0	72	599
17:30	26	196	13	4	239	15	37	43	0	95	45	188	17	1	251	7	34	42	0	83	668
17:45	34	191	9	1	235	4	33	33	0	70	36	143	15	2	196	3	44	35	0	82	583
Total	106	719	33	12	870	38	157	148	0	343	166	702	64	6	938	19	140	155	0	314	2465
Grand Total	492	3022	103	48	3665	129	465	535	0	1129	591	2174	209	16	2990	45	469	648	0	1162	8946
Apprch %	13.4	82.5	2.8	1.3		11.4	41.2	47.4	0		19.8	72.7	7	0.5		3.9	40.4	55.8	0		
Total %	5.5	33.8	1.2	0.5	41	1.4	5.2	6	0	12.6	6.6	24.3	2.3	0.2	33.4	0.5	5.2	7.2	0	13	
Autos	472	2939										2108									
% Autos	95.9	97.3	97.1	97.9	97.1	90.7	99.4	98.5	0	98	98.3	97	98.1	100	97.3	95.6	99.1	97.7	0	98.2	97.4
Heavy Vehicles																					
% Heavy Vehicles	4.1	2.7	2.9	2.1	2.9	9.3	0.6	1.5	0	2	1.7	3	1.9	0	2.7	4.4	0.9	2.3	0	1.8	2.6

Traf Tech Engineering Inc.

File Name : 4-Alton Rd & Dade Ave
 Site Code : 00000000
 Start Date : 8/9/2023
 Page No : 2

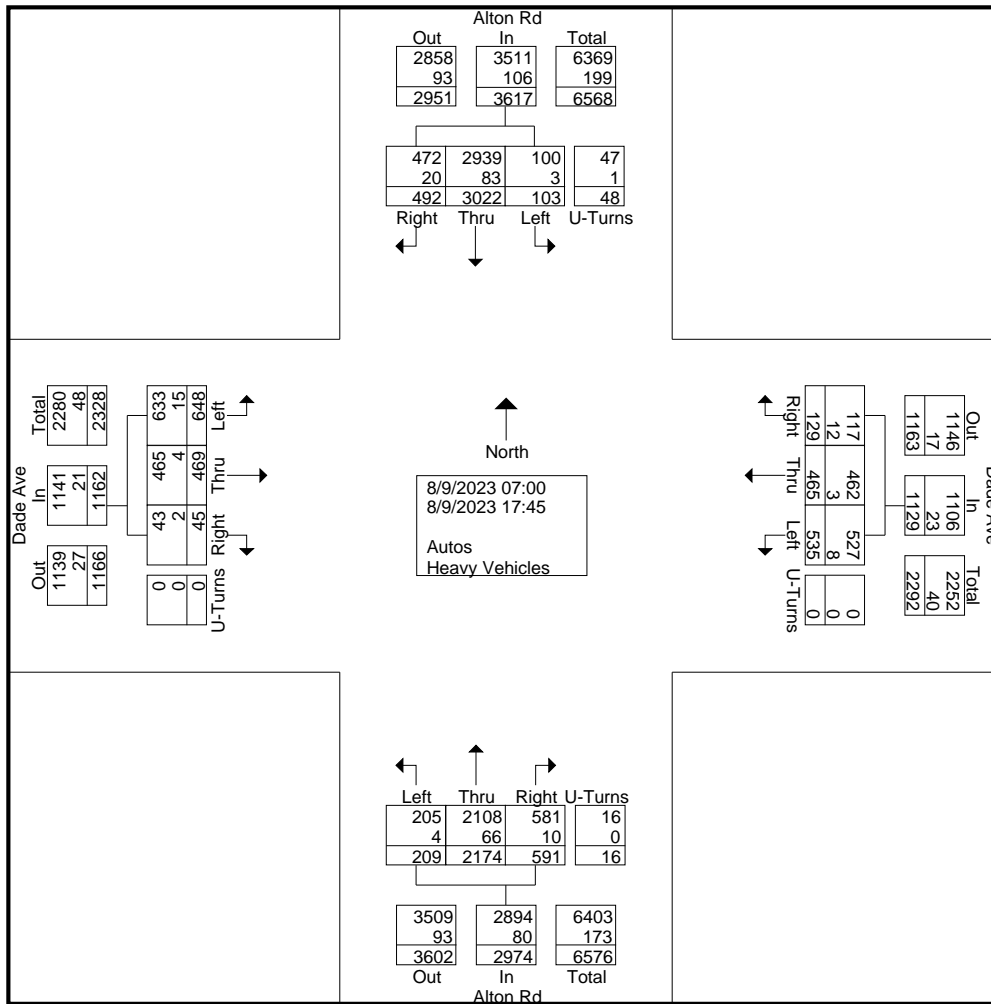

Traf Tech Engineering Inc.

File Name : 4-Alton Rd & Dade Ave
 Site Code : 00000000
 Start Date : 8/9/2023
 Page No : 3

Start Time	Alton Rd From North					Dade Ave From East					Alton Rd From South					Dade Ave From West					Int. Total
	Right	Thru	Left	U-Turns	App. Total	Right	Thru	Left	U-Turns	App. Total	Right	Thru	Left	U-Turns	App. Total	Right	Thru	Left	U-Turns	App. Total	
Peak Hour Analysis From 07:00 to 17:45 - Peak 1 of 1																					
Peak Hour for Entire Intersection Begins at 16:15																					
16:15	27	184	7	5	223	9	40	47	0	96	44	235	15	0	294	4	39	55	0	98	711
16:30	19	171	4	8	202	8	35	42	0	85	37	181	14	2	234	2	43	59	0	104	625
16:45	23	174	9	3	209	16	45	37	0	98	54	191	15	1	261	4	34	42	0	80	648
17:00	21	174	6	4	205	10	46	34	0	90	47	176	18	2	243	8	26	43	0	77	615
Total Volume	90	703	26	20	839	43	166	160	0	369	182	783	62	5	1032	18	142	199	0	359	2599
% App. Total	10.7	83.8	3.1	2.4		11.7	45	43.4	0		17.6	75.9	6	0.5		5	39.6	55.4	0		
PHF	.833	.955	.722	.625	.941	.672	.902	.851	.000	.941	.843	.833	.861	.625	.878	.563	.826	.843	.000	.863	.914
Autos	89	690	26	20	825	40	165	160	0	365	182	769	62	5	1018	18	141	196	0	355	2563
% Autos	98.9	98.2	100	100	98.3	93.0	99.4	100	0	98.9	100	98.2	100	100	98.6	100	99.3	98.5	0	98.9	98.6
Heavy Vehicles																					
% Heavy Vehicles	1.1	1.8	0	0	1.7	7.0	0.6	0	0	1.1	0	1.8	0	0	1.4	0	0.7	1.5	0	1.1	1.4

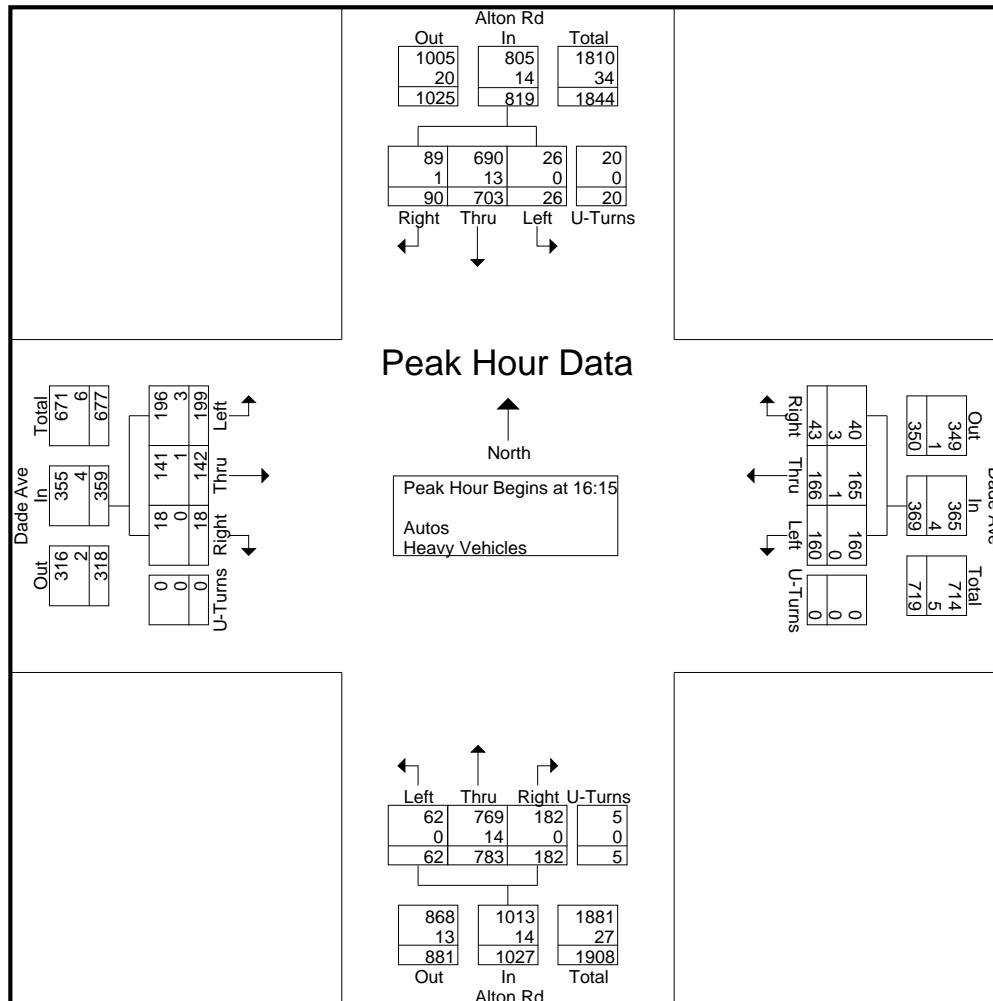

Traf Tech Engineering Inc.

File Name : 4-Alton Rd & Dade Ave
 Site Code : 00000000
 Start Date : 8/9/2023
 Page No : 4

Start Time	Alton Rd From North					Dade Ave From East					Alton Rd From South					Dade Ave From West					Int. Total
	Right	Thru	Left	U-Turns	App. Total	Right	Thru	Left	U-Turns	App. Total	Right	Thru	Left	U-Turns	App. Total	Right	Thru	Left	U-Turns	App. Total	
Peak Hour Analysis From 07:00 to 08:45 - Peak 1 of 1																					
Peak Hour for Entire Intersection Begins at 08:00																					
08:00	45	181	8	4	238	8	25	31	0	64	34	88	13	1	136	3	31	40	0	74	512
08:15	35	206	10	3	254	13	19	27	0	59	32	109	20	1	162	2	24	43	0	69	544
08:30	30	242	7	0	279	8	15	30	0	53	37	110	11	0	158	1	32	49	0	82	572
08:45	39	239	3	4	285	8	36	35	0	79	50	106	13	2	171	2	35	45	0	82	617
Total Volume	149	868	28	11	1056	37	95	123	0	255	153	413	57	4	627	8	122	177	0	307	2245
% App. Total	14.1	82.2	2.7	1		14.5	37.3	48.2	0		24.4	65.9	9.1	0.6		2.6	39.7	57.7	0		
PHF	.828	.897	.700	.688	.926	.712	.660	.879	.000	.807	.765	.939	.713	.500	.917	.667	.871	.903	.000	.936	.910
Autos	141	833	28	11	1013	31	95	120	0	246	148	394	55	4	601	7	120	170	0	297	2157
% Autos	94.6	96.0	100	100	95.9	83.8	100	97.6	0	96.5	96.7	95.4	96.5	100	95.9	87.5	98.4	96.0	0	96.7	96.1
Heavy Vehicles																					
% Heavy Vehicles	5.4	4.0	0	0	4.1	16.2	0	2.4	0	3.5	3.3	4.6	3.5	0	4.1	12.5	1.6	4.0	0	3.3	3.9

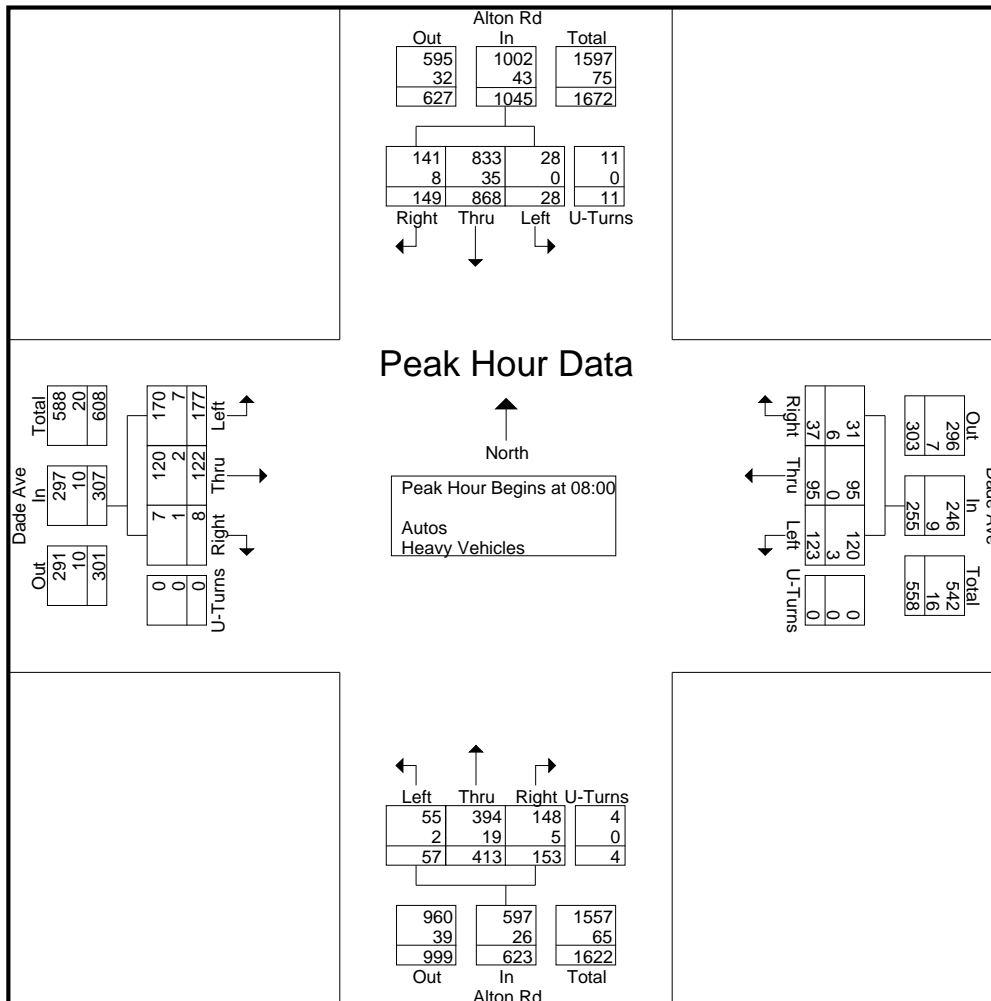

Traf Tech Engineering Inc.

File Name : 4-Alton Rd & Dade Ave

Site Code : 00000000

Start Date : 8/9/2023

Page No : 5

Start Time	Alton Rd From North					Dade Ave From East					Alton Rd From South					Dade Ave From West					Int. Total
	Right	Thru	Left	U-Turns	App. Total	Right	Thru	Left	U-Turns	App. Total	Right	Thru	Left	U-Turns	App. Total	Right	Thru	Left	U-Turns	App. Total	

Peak Hour Analysis From 16:00 to 17:45 - Peak 1 of 1

Peak Hour for Entire Intersection Begins at 16:15

16:15	27	184	7	5	223	9	40	47	0	96	44	235	15	0	294	4	39	55	0	98	711
16:30	19	171	4	8	202	8	35	42	0	85	37	181	14	2	234	2	43	59	0	104	625
16:45	23	174	9	3	209	16	45	37	0	98	54	191	15	1	261	4	34	42	0	80	648
17:00	21	174	6	4	205	10	46	34	0	90	47	176	18	2	243	8	26	43	0	77	615
Total Volume	90	703	26	20	839	43	166	160	0	369	182	783	62	5	1032	18	142	199	0	359	2599
% App. Total	10.7	83.8	3.1	2.4		11.7	45	43.4	0		17.6	75.9	6	0.5		5	39.6	55.4	0		
PHF	.833	.955	.722	.625	.941	.672	.902	.851	.000	.941	.843	.833	.861	.625	.878	.563	.826	.843	.000	.863	.914
Autos	89	690	26	20	825	40	165	160	0	365	182	769	62	5	1018	18	141	196	0	355	2563
% Autos	98.9	98.2	100	100	98.3	93.0	99.4	100	0	98.9	100	98.2	100	100	98.6	100	99.3	98.5	0	98.9	98.6
Heavy Vehicles	1.1	1.8	0	0	1.7	7.0	0.6	0	0	1.1	0	1.8	0	0	1.4	0	0.7	1.5	0	1.1	1.4
% Heavy Vehicles																					

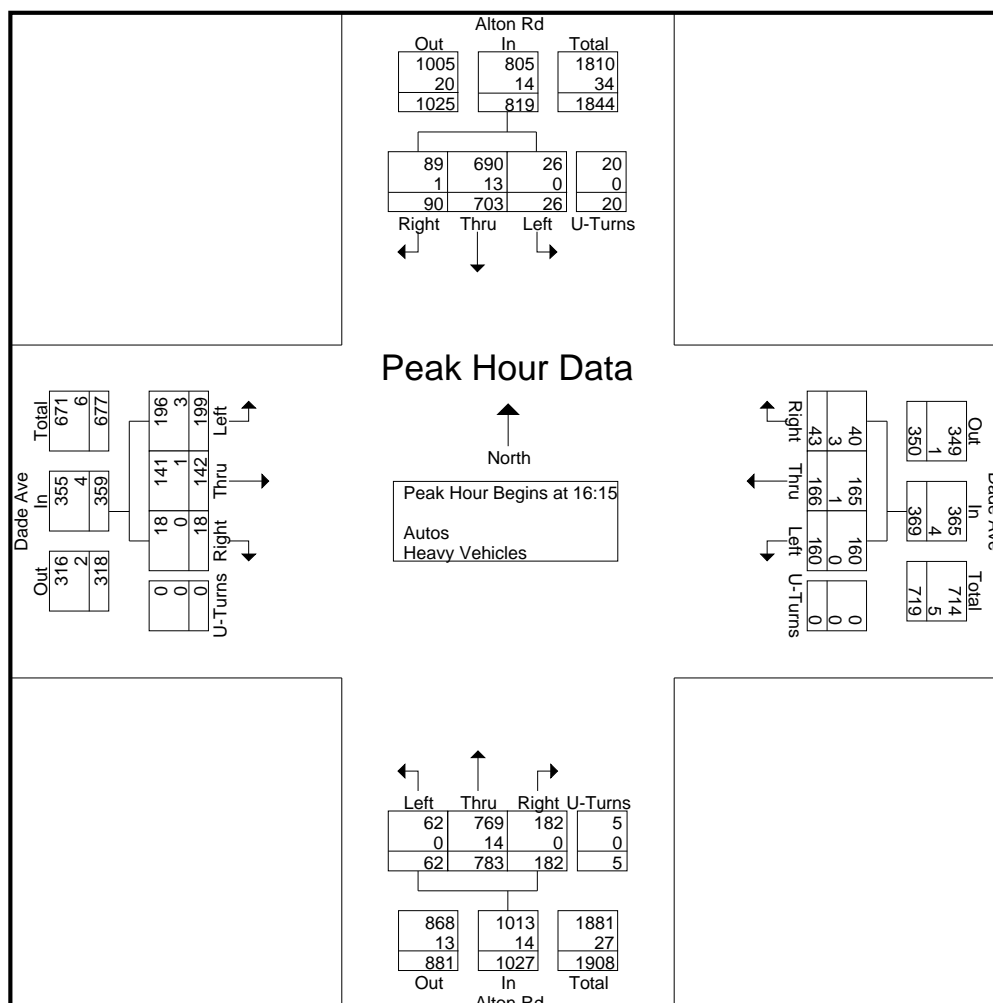

Traf Tech Engineering Inc.

File Name : 5-Michigan Ave & Dade Ave
 Site Code : 00000000
 Start Date : 8/9/2023
 Page No : 1

Groups Printed- Peds & Bikes

Start Time	Michigan Ave From North				Dade Ave From East				Michigan Ave From South				Dade Ave From West				Int. Total	
	Bikes			Peds	Bikes			Peds	Bikes			Peds	Bikes			Peds		
07:00	1	0	0	1	0	0	0	0	0	0	0	0	0	0	0	0	1	3
07:15	3	0	0	1	0	0	0	0	0	0	0	0	1	0	0	0	0	5
07:30	2	0	0	2	0	0	0	0	0	0	0	0	0	0	0	0	0	4
07:45	2	0	0	2	0	0	0	0	0	0	0	0	0	0	0	0	0	4
Total	8	0	0	6	0	0	0	0	0	0	0	0	1	0	0	0	1	16
08:00	1	0	0	0	0	0	0	0	0	0	0	0	1	0	0	0	0	2
08:15	2	0	0	3	0	0	0	0	0	0	0	0	0	0	0	0	0	5
08:30	2	0	0	0	0	0	0	0	0	0	0	0	0	0	0	0	0	2
08:45	1	0	0	1	0	0	0	0	0	0	0	0	0	0	0	0	0	2
Total	6	0	0	4	0	0	0	0	0	0	0	0	1	0	0	0	0	11
*** BREAK ***																		
16:00	2	0	0	1	0	0	0	0	0	0	0	0	0	0	0	0	1	4
16:15	0	0	0	1	0	0	0	0	0	0	0	0	0	0	0	0	0	1
16:30	2	0	0	3	0	0	0	0	0	0	0	0	0	0	0	0	0	5
16:45	1	0	0	8	0	0	0	0	0	0	0	0	0	0	0	0	0	9
Total	5	0	0	13	0	0	0	0	0	0	0	0	0	0	0	0	1	19
17:00	1	0	0	7	0	0	0	0	0	0	0	0	0	0	0	0	0	8
17:15	2	0	0	6	0	0	0	0	0	0	0	0	0	0	0	0	0	8
17:30	2	0	0	3	0	0	0	0	0	0	0	0	0	0	0	0	0	5
17:45	1	0	0	8	0	0	0	0	0	0	0	0	0	0	0	0	0	9
Total	6	0	0	24	0	0	0	0	0	0	0	0	0	0	0	0	0	30
Grand Total	25	0	0	47	0	0	0	0	0	0	0	0	2	0	0	2		76
Apprch %	34.7	0	0	65.3	0	0	0	0	0	0	0	0	50	0	0	50		
Total %	32.9	0	0	61.8	0	0	0	0	0	0	0	0	2.6	0	0	2.6		

Traf Tech Engineering Inc.

File Name : 5-Michigan Ave & Dade Ave
 Site Code : 00000000
 Start Date : 8/9/2023
 Page No : 1

Groups Printed- Autos - Heavy Vehicles

Start Time	Michigan Ave From North					Dade Ave From East					Michigan Ave From South					Dade Ave From West					Int. Total
	Right	Thru	Left	U-Turns	App. Total	Right	Thru	Left	U-Turns	App. Total	Right	Thru	Left	U-Turns	App. Total	Right	Thru	Left	U-Turns	App. Total	
07:00	3	0	62	0	65	54	29	0	0	83	0	0	0	0	0	0	39	0	0	39	187
07:15	2	0	78	0	80	35	46	0	0	81	0	0	0	0	0	0	31	0	0	31	192
07:30	1	0	80	0	81	70	32	0	0	102	0	0	0	0	0	0	48	0	0	48	231
07:45	1	0	67	0	68	33	42	0	0	75	0	0	0	0	0	0	36	0	0	36	179
Total	7	0	287	0	294	192	149	0	0	341	0	0	0	0	0	0	154	0	0	154	789
08:00	4	0	84	0	88	64	47	0	0	111	0	0	0	0	0	0	75	0	0	75	274
08:15	4	0	99	0	103	65	55	0	0	120	0	0	0	0	0	0	60	0	0	60	283
08:30	2	0	105	0	107	48	50	0	0	98	0	0	0	0	0	0	73	0	0	73	278
08:45	7	0	123	0	130	68	85	0	0	153	0	0	0	0	0	0	80	0	0	80	363
Total	17	0	411	0	428	245	237	0	0	482	0	0	0	0	0	0	288	0	0	288	1198
*** BREAK ***																					
16:00	9	0	104	0	113	206	78	0	0	284	0	0	0	0	0	0	71	0	0	71	468
16:15	7	0	56	0	63	147	86	0	0	233	0	0	0	0	0	0	76	0	0	76	372
16:30	7	0	95	0	102	159	91	0	0	250	0	0	0	0	0	0	89	0	0	89	441
16:45	1	0	84	0	85	142	89	0	0	231	0	0	0	0	0	0	108	0	0	108	424
Total	24	0	339	0	363	654	344	0	0	998	0	0	0	0	0	0	344	0	0	344	1705
17:00	5	0	77	0	82	158	85	0	0	243	0	0	0	0	0	0	75	0	0	75	400
17:15	6	0	66	0	72	174	95	0	0	269	0	0	0	0	0	0	87	0	0	87	428
17:30	7	0	70	0	77	120	91	0	0	211	0	0	0	0	0	0	76	0	0	76	364
17:45	4	0	54	0	58	116	85	0	0	201	0	0	0	0	0	0	88	0	0	88	347
Total	22	0	267	0	289	568	356	0	0	924	0	0	0	0	0	0	326	0	0	326	1539
Grand Total	70	0	1304	0	1374	1659	1086	0	0	2745	0	0	0	0	0	0	1112	0	0	1112	5231
Apprch %	5.1	0	94.9	0		60.4	39.6	0	0		0	0	0	0	0	0	100	0	0		
Total %	1.3	0	24.9	0	26.3	31.7	20.8	0	0	52.5	0	0	0	0	0	0	21.3	0	0	21.3	
Autos	70	0	1287			1648	1069										1108				
% Autos	100	0	98.7	0	98.8	99.3	98.4	0	0	99	0	0	0	0	0	0	99.6	0	0	99.6	99.1
Heavy Vehicles																					
% Heavy Vehicles	0	0	1.3	0	1.2	0.7	1.6	0	0	1	0	0	0	0	0	0	0.4	0	0	0.4	0.9

Traf Tech Engineering Inc.

File Name : 5-Michigan Ave & Dade Ave

Site Code : 00000000

Start Date : 8/9/2023

Page No : 2

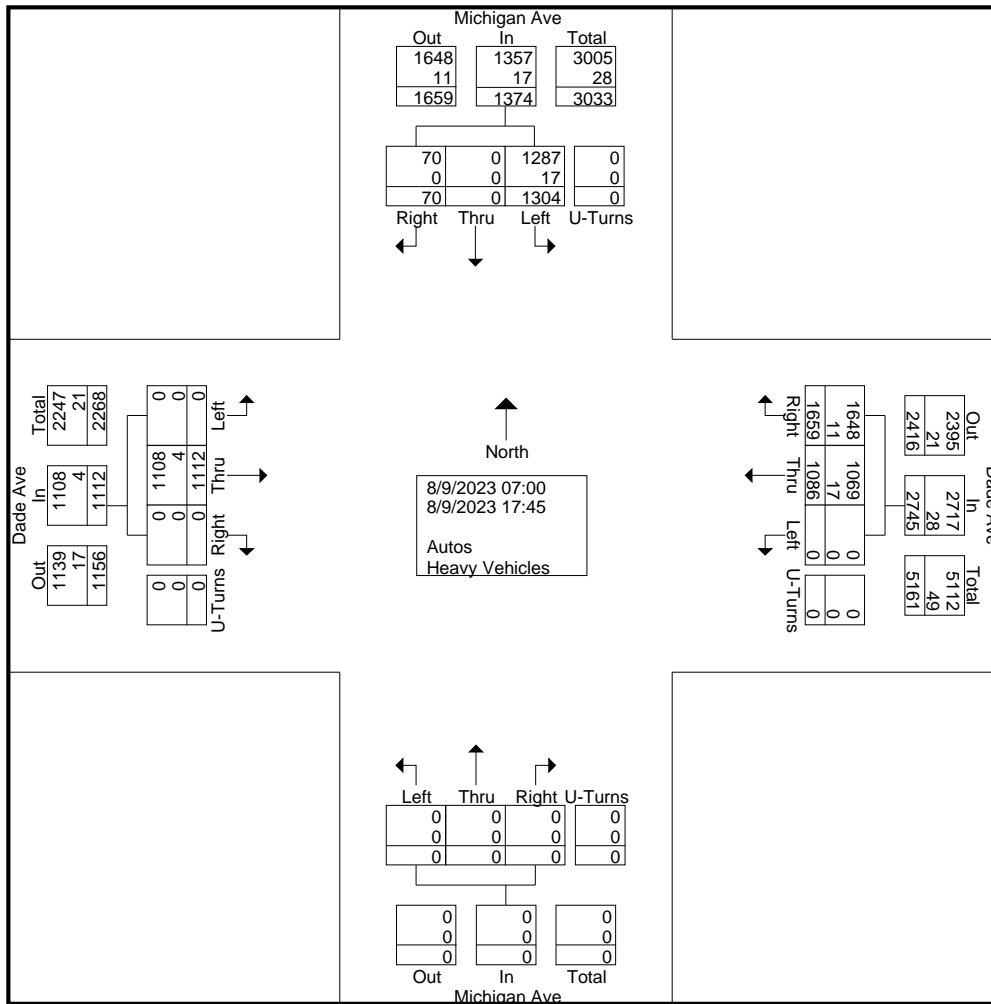

Traf Tech Engineering Inc.

File Name : 5-Michigan Ave & Dade Ave
 Site Code : 00000000
 Start Date : 8/9/2023
 Page No : 3

Start Time	Michigan Ave From North					Dade Ave From East					Michigan Ave From South					Dade Ave From West					Int. Total
	Right	Thru	Left	U-Turns	App. Total	Right	Thru	Left	U-Turns	App. Total	Right	Thru	Left	U-Turns	App. Total	Right	Thru	Left	U-Turns	App. Total	
Peak Hour Analysis From 07:00 to 17:45 - Peak 1 of 1																					
Peak Hour for Entire Intersection Begins at 16:00																					
16:00	9	0	104	0	113	206	78	0	0	284	0	0	0	0	0	0	71	0	0	71	468
16:15	7	0	56	0	63	147	86	0	0	233	0	0	0	0	0	0	76	0	0	76	372
16:30	7	0	95	0	102	159	91	0	0	250	0	0	0	0	0	0	89	0	0	89	441
16:45	1	0	84	0	85	142	89	0	0	231	0	0	0	0	0	0	108	0	0	108	424
Total Volume	24	0	339	0	363	654	344	0	0	998	0	0	0	0	0	0	344	0	0	344	1705
% App. Total	6.6	0	93.4	0		65.5	34.5	0	0		0	0	0	0	0	0	100	0	0		
PHF	.667	.000	.815	.000	.803	.794	.945	.000	.000	.879	.000	.000	.000	.000	.000	.000	.796	.000	.000	.796	.911
Autos	24	0	338	0	362	654	341	0	0	995	0	0	0	0	0	0	343	0	0	343	1700
% Autos	100	0	99.7	0	99.7	100	99.1	0	0	99.7	0	0	0	0	0	0	99.7	0	0	99.7	99.7
Heavy Vehicles																					
% Heavy Vehicles	0	0	0.3	0	0.3	0	0.9	0	0	0.3	0	0	0	0	0	0	0.3	0	0	0.3	0.3

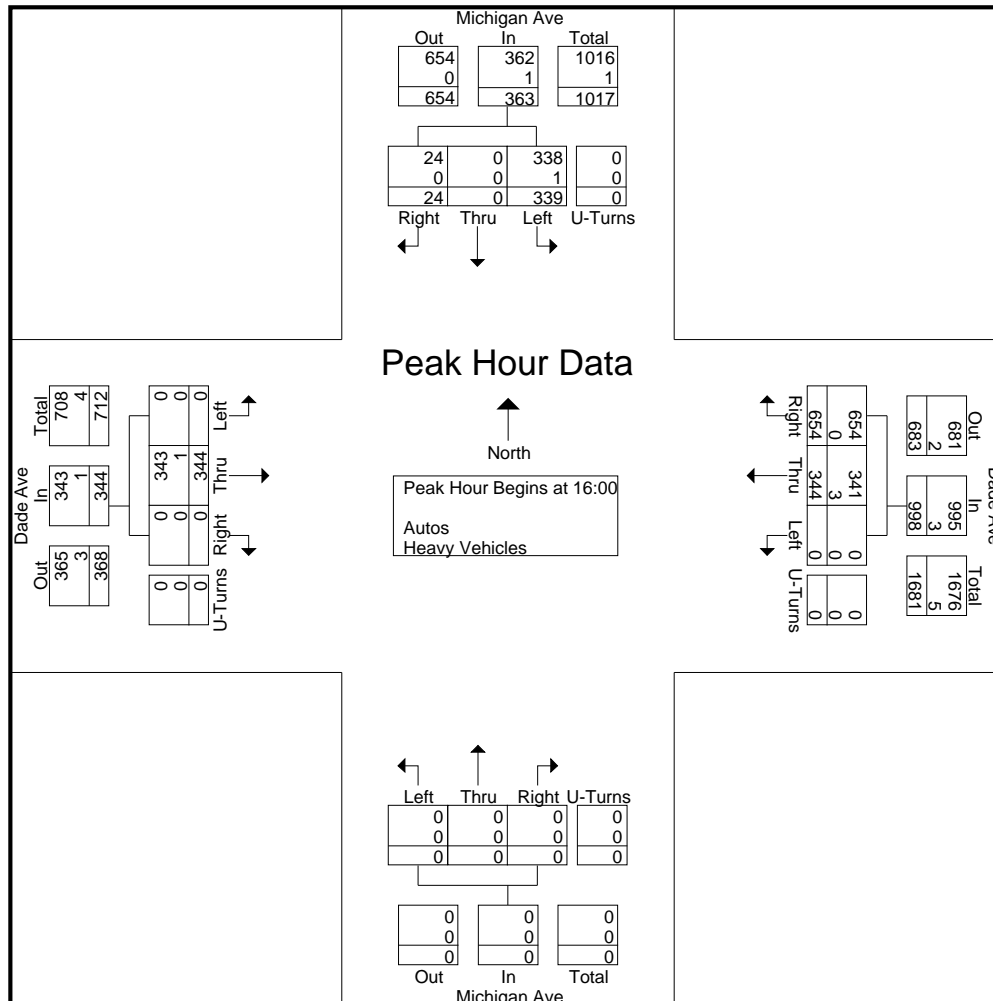

Traf Tech Engineering Inc.

File Name : 5-Michigan Ave & Dade Ave
 Site Code : 00000000
 Start Date : 8/9/2023
 Page No : 4

Start Time	Michigan Ave From North					Dade Ave From East					Michigan Ave From South					Dade Ave From West					Int. Total
	Right	Thru	Left	U-Turns	App. Total	Right	Thru	Left	U-Turns	App. Total	Right	Thru	Left	U-Turns	App. Total	Right	Thru	Left	U-Turns	App. Total	
Peak Hour Analysis From 07:00 to 08:45 - Peak 1 of 1																					
Peak Hour for Entire Intersection Begins at 08:00																					
08:00	4	0	84	0	88	64	47	0	0	111	0	0	0	0	0	0	75	0	0	75	274
08:15	4	0	99	0	103	65	55	0	0	120	0	0	0	0	0	0	60	0	0	60	283
08:30	2	0	105	0	107	48	50	0	0	98	0	0	0	0	0	0	73	0	0	73	278
08:45	7	0	123	0	130	68	85	0	0	153	0	0	0	0	0	0	80	0	0	80	363
Total Volume	17	0	411	0	428	245	237	0	0	482	0	0	0	0	0	0	288	0	0	288	1198
% App. Total	4	0	96	0		50.8	49.2	0	0		0	0	0	0	0	0	100	0	0		
PHF	.607	.000	.835	.000	.823	.901	.697	.000	.000	.788	.000	.000	.000	.000	.000	.000	.900	.000	.000	.900	.825
Autos	17	0	406	0	423	241	232	0	0	473	0	0	0	0	0	0	286	0	0	286	1182
% Autos	100	0	98.8	0	98.8	98.4	97.9	0	0	98.1	0	0	0	0	0	0	99.3	0	0	99.3	98.7
Heavy Vehicles																					
% Heavy Vehicles	0	0	1.2	0	1.2	1.6	2.1	0	0	1.9	0	0	0	0	0	0	0.7	0	0	0.7	1.3

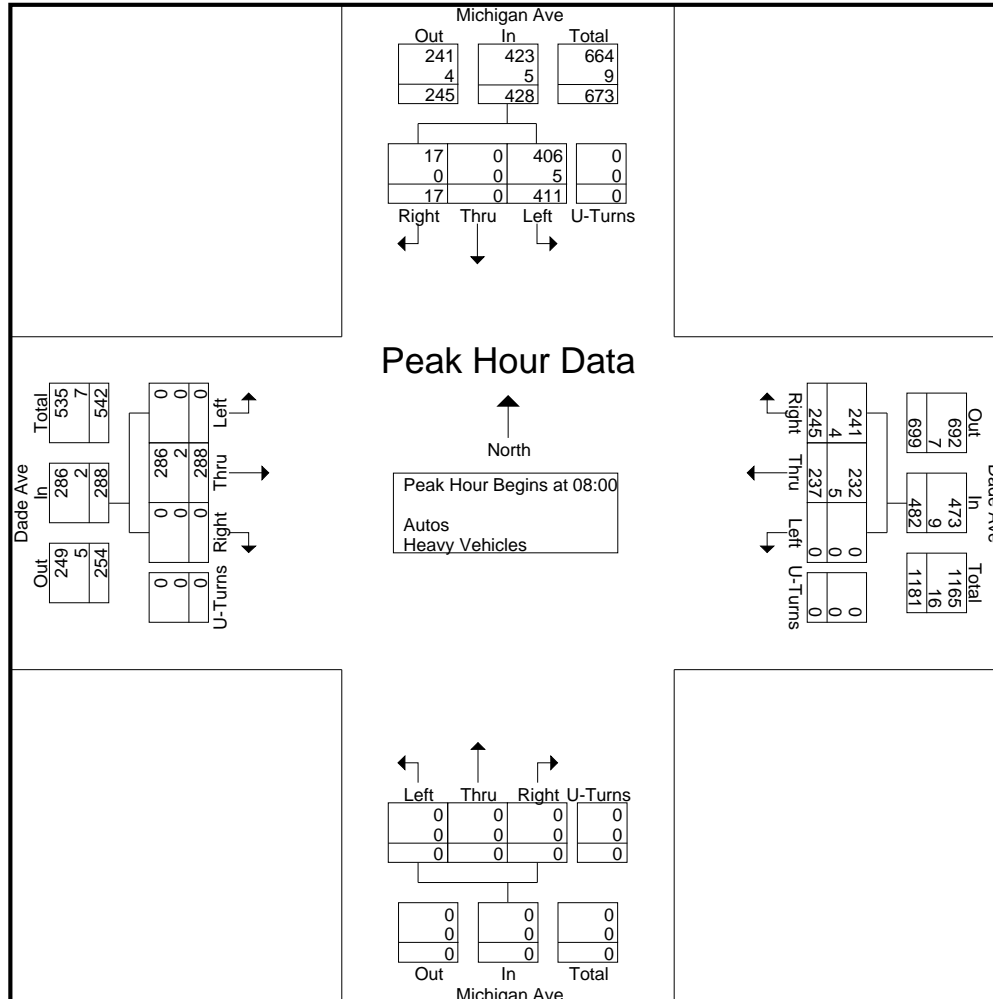

Traf Tech Engineering Inc.

File Name : 5-Michigan Ave & Dade Ave
 Site Code : 00000000
 Start Date : 8/9/2023
 Page No : 5

Start Time	Michigan Ave From North					Dade Ave From East					Michigan Ave From South					Dade Ave From West					Int. Total
	Right	Thru	Left	U-Turns	App. Total	Right	Thru	Left	U-Turns	App. Total	Right	Thru	Left	U-Turns	App. Total	Right	Thru	Left	U-Turns	App. Total	
Peak Hour Analysis From 16:00 to 17:45 - Peak 1 of 1																					
Peak Hour for Entire Intersection Begins at 16:00																					
16:00	9	0	104	0	113	206	78	0	0	284	0	0	0	0	0	0	71	0	0	71	468
16:15	7	0	56	0	63	147	86	0	0	233	0	0	0	0	0	0	76	0	0	76	372
16:30	7	0	95	0	102	159	91	0	0	250	0	0	0	0	0	0	89	0	0	89	441
16:45	1	0	84	0	85	142	89	0	0	231	0	0	0	0	0	0	108	0	0	108	424
Total Volume	24	0	339	0	363	654	344	0	0	998	0	0	0	0	0	0	344	0	0	344	1705
% App. Total	6.6	0	93.4	0		65.5	34.5	0	0		0	0	0	0	0	0	100	0	0		
PHF	.667	.000	.815	.000	.803	.794	.945	.000	.000	.879	.000	.000	.000	.000	.000	.000	.796	.000	.000	.796	.911
Autos	24	0	338	0	362	654	341	0	0	995	0	0	0	0	0	0	343	0	0	343	1700
% Autos	100	0	99.7	0	99.7	100	99.1	0	0	99.7	0	0	0	0	0	0	99.7	0	0	99.7	99.7
Heavy Vehicles																					
% Heavy Vehicles	0	0	0.3	0	0.3	0	0.9	0	0	0.3	0	0	0	0	0	0	0.3	0	0	0.3	0.3

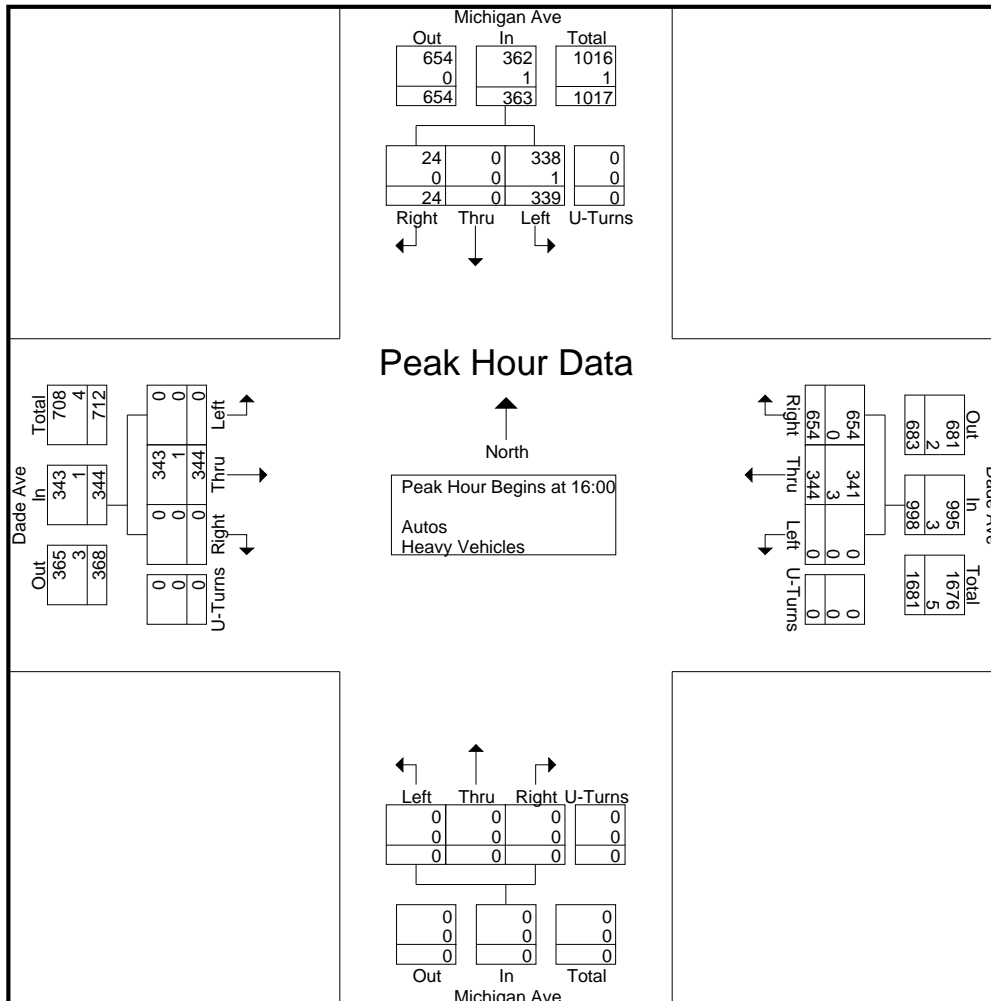

APPENDIX C

**Signal Timing, PSCF, Historical Data,
Growth Rate, and Directional Trip
Distribution Reports**









TOD Schedule Report
for 2648: Alton Rd&Dade Blvd

Print Date:
10/4/2021

Print Time:
3:11 PM

<u>Asset</u>	<u>Intersection</u>	<u>TOD Schedule</u>	<u>Op Mode</u>	<u>Plan #</u>	<u>Cycle</u>	<u>Offset</u>	<u>TOD Setting</u>	<u>Active PhaseBank</u>	<u>Active Maximum</u>
2648	Alton Rd&Dade Blvd	DOW-2	TOD	[10] PRE-PM PEAK	150	24	N/A	1	Max 2

Splits

<u>PH 1</u>	<u>PH 2</u>	<u>PH 3</u>	<u>PH 4</u>	<u>PH 5</u>	<u>PH 6</u>	<u>PH 7</u>	<u>PH 8</u>
NBL	SBT	NEL	SWT	SBL	NBT	SWL	NET
11	70	10	34	11	70	14	31
							

Active Phase Bank: Phase Bank 1

Phase	<u>Walk</u>			<u>Don't Walk</u>			<u>Min Initial</u>			<u>Veh Ext</u>			<u>Max Limit</u>			<u>Max 2</u>			<u>Yellow</u>	<u>Red</u>
	1	2	3	1	2	3	1	2	3	1	2	3	1	2	3	1	2	3		
1 NBL	0	0	0	0	0	0	5	5	5	2	2	2	10	7	8	23	5	12	3.7	2
2 SBT	4	4	4	19	19	19	4	7	7	1	1	1	30	45	30	0	30	30	4	2
3 NEL	0	0	0	0	0	0	5	5	5	2	2	2	7	5	8	22	5	12	3.7	2
4 SWT	4	4	4	27	27	27	7	7	7	2.5	-2.5	-2.5	12	22	20	40	22	25	4	2
5 SBL	0	0	0	0	0	0	5	5	5	2	2	2	10	7	8	23	5	12	3.7	2
6 NBT	4	4	4	19	19	19	4	7	7	1	1	1	30	45	30	0	30	30	4	2
7 SWL	0	0	0	0	0	0	5	5	5	2	2	2	8	5	8	22	5	12	3.7	2
8 NET	4	4	4	27	27	27	7	7	7	2.5	-2.5	-2.5	12	22	20	40	22	25	4	2

Last In Service Date: unknown

Permitted Phases	
	12345678
Default	12345678
External Permit 0	-2-456-8
External Permit 1	-2-456-8
External Permit 2	-2-456-8

TOD Schedule Report
for 2648: Alton Rd&Dade Blvd

Print Date:
10/4/2021

Print Time:
3:11 PM

Current TOD Schedule	Plan	Cycle	Green Time								Ring Offset	Offset
			1 NBL	2 SBT	3 NEL	4 SWT	5 SBL	6 NBT	7 SWL	8 NET		
1		100	10	23	11	32	10	23	9	34	0	15
3		120	9	42	11	34	9	42	11	34	0	75
5		150	11	70	10	34	11	70	14	31	0	25
10		150	11	70	10	34	11	70	14	31	0	24
13		130	8	50	11	37	8	50	11	37	0	50
19		120	9	42	11	34	9	42	11	34	0	35
20		140	9	62	11	34	9	62	11	34	0	105
21		140	5	73	5	33	5	73	5	33	0	97
22		120	9	42	11	34	9	42	11	34	0	25
25		140	7	60	16	33	7	60	11	34	0	9
26		200	19	105	21	31	19	105	21	31	0	168
27		180	9	102	11	34	9	102	11	34	0	118

Local TOD Schedule		
Time	Plan	DOW
0000	1	Su M T W Th F S
0600	3	Su M T W Th F S
0800	5	M T W Th F
0800	19	Su S
1000	20	Su S
1300	10	M T W Th F
1900	13	Su M T W Th F S
2000	22	Su S

Current Time of Day Function			
Time	Function	Settings *	Day of Week
0000	TOD OUTPUTS	-----	SuM T W ThF S
0000	TOD LOCAL MULTIFU	----4---	SuM T W ThF S
0500	TOD LOCAL MULTIFU	-----	SuM T W ThF S

Local Time of Day Function			
Time	Function	Settings *	Day of Week
0000	TOD OUTPUTS	-----	SuM T W ThF S
0000	TOD LOCAL MULTIFUNCT	----4---	SuM T W ThF S
0500	TOD LOCAL MULTIFUNCT	-----	SuM T W ThF S

* Settings
Blank - FREE - Phase Bank 1, Max 1
Blank - Plan - Phase Bank 1, Max 2
1 - Phase Bank 2, Max 1
2 - Phase Bank 2, Max 2
3 - Phase Bank 3, Max 1
4 - Phase Bank 3, Max 2
5 - EXTERNAL PERMIT 1
6 - EXTERNAL PERMIT 2
7 - X-PED OMIT
8 - TBA

No Calendar Defined/Enabled

TOD Schedule Report
for 3276: Alton Rd&20 St

Print Date:
10/4/2021

Print Time:
4:20 PM

<u>Asset</u>	<u>Intersection</u>	<u>TOD Schedule</u>	<u>Op Mode</u>	<u>Plan #</u>	<u>Cycle</u>	<u>Offset</u>	<u>TOD Setting</u>	<u>Active PhaseBank</u>	<u>Active Maximum</u>
3276	Alton Rd&20 St	DOW-2	TOD	[10] PRE-PM PEAK	150	129	N/A	1	Max 2

Splits

<u>PH 1</u>	<u>PH 2</u>	<u>PH 3</u>	<u>PH 4</u>	<u>PH 5</u>	<u>PH 6</u>	<u>PH 7</u>	<u>PH 8</u>
NBL	SBT	EBT	WBT	-	NBT	-	-
6	80	27	12	0	92	0	0

Active Phase Bank: Phase Bank 1

<u>Phase</u>	<u>Walk</u>			<u>Don't Walk</u>			<u>Min Initial</u>			<u>Veh Ext</u>			<u>Max Limit</u>			<u>Max 2</u>			<u>Yellow</u>	<u>Red</u>
	1	2	3	1	2	3	1	2	3	1	2	3	1	2	3	1	2	3		
1 NBL	0	0	0	0	0	0	5	5	5	2	2	2	5	5	5	12	12	12	4	2
2 SBT	5	4	5	29	29	29	7	7	7	1	1	1	30	30	30	0	0	0	4	3.3
3 EBT	5	4	5	21	21	21	7	7	7	2.5	2.5	2.5	12	12	12	16	22	22	4	2
4 WBT	0	0	0	0	0	0	7	7	7	2.5	2.5	2.5	7	9	9	15	14	14	4	2.3
5 -	0	0	0	0	0	0	0	0	0	0	0	0	0	0	0	0	0	0	0	0
6 NBT	5	4	5	29	29	29	7	7	7	1	1	1	30	30	30	0	0	0	4	3.3
7 -	0	0	0	0	0	0	0	0	0	0	0	0	0	0	0	0	0	0	0	0
8 -	0	0	0	0	0	0	0	0	0	0	0	0	0	0	0	0	0	0	0	0

Last In Service Date: unknown

Permitted Phases	
	12345678
Default	1234-6--
External Permit 0	-23--6--
External Permit 1	-23--6--
External Permit 2	-23--6--

TOD Schedule Report
for 3276: Alton Rd&20 St

Print Date:
10/4/2021

Print Time:
4:20 PM

Current TOD Schedule	Plan	Cycle	Green Time								Ring Offset	Offset
			1 NBL	2 SBT	3 EBT	4 WBT	5 -	6 NBT	7 -	8 -		
1		100	6	34	27	8	0	46	0	0	0	11
3		120	10	50	27	8	0	66	0	0	0	77
5		150	9	80	27	9	0	95	0	0	0	23
10		150	6	80	27	12	0	92	0	0	0	129
13		130	10	60	27	8	0	76	0	0	0	53
19		120	9	50	27	9	0	65	0	0	0	94
20		140	9	70	27	9	0	85	0	0	0	104
21		140	6	74	27	8	0	86	0	0	0	97
22		120	9	50	27	9	0	65	0	0	0	94
25		140	6	73	27	9	0	85	0	0	0	0
26		200	6	133	27	9	0	145	0	0	0	178
27		180	6	113	27	9	0	125	0	0	0	131

Local TOD Schedule		
Time	Plan	DOW
0000	1	Su M T W Th F S
0600	3	Su M T W Th F S
0800	5	M T W Th F
0800	19	Su S
1000	20	Su S
1300	10	M T W Th F
1900	13	Su M T W Th F S
2000	22	Su S

Current Time of Day Function			
Time	Function	Settings *	Day of Week
0000	TOD OUTPUTS	8-----	SuM T W ThF S
0000	TOD LOCAL MULTIFU	----4---	SuM T W ThF S
0500	TOD LOCAL MULTIFU	-----	SuM T W ThF S
0600	TOD OUTPUTS	-----	M T W ThF
2000	TOD OUTPUTS	8-----	M T W ThF

Local Time of Day Function			
Time	Function	Settings *	Day of Week
0000	TOD OUTPUTS	8-----	SuM T W ThF S
0000	TOD LOCAL MULTIFUNCT	----4---	SuM T W ThF S
0500	TOD LOCAL MULTIFUNCT	-----	SuM T W ThF S
0600	TOD OUTPUTS	-----	M T W ThF
0700	TOD OUTPUTS	-----	Su S
2000	TOD OUTPUTS	8-----	M T W ThF
2200	TOD OUTPUTS	8-----	Su S

* Settings
Blank - FREE - Phase Bank 1, Max 1
Blank - Plan - Phase Bank 1, Max 2
1 - Phase Bank 2, Max 1
2 - Phase Bank 2, Max 2
3 - Phase Bank 3, Max 1
4 - Phase Bank 3, Max 2
5 - EXTERNAL PERMIT 1
6 - EXTERNAL PERMIT 2
7 - X-PED OMIT
8 - TBA

No Calendar Defined/Enabled



TOD Schedule Report
for 3391: Dade Blvd&Michigan Av N

Print Date:
10/4/2021

Print Time:
4:32 PM

<u>Asset</u>	<u>Intersection</u>	<u>TOD Schedule</u>	<u>Op Mode</u>	<u>Plan #</u>	<u>Cycle</u>	<u>Offset</u>	<u>TOD Setting</u>	<u>Active PhaseBank</u>	<u>Active Maximum</u>
3391	Dade Blvd&Michigan Av N	DOW-2	TOD	[04] HEAVY AM PEAK	110	86	N/A	1	Max 2

Splits

<u>PH 1</u>	<u>PH 2</u>	<u>PH 3</u>	<u>PH 4</u>	<u>PH 5</u>	<u>PH 6</u>	<u>PH 7</u>	<u>PH 8</u>
-	SWT	PED	SET	-	NET	-	-
0	28	27	43	0	28	0	0
	N/A						

Active Phase Bank: Phase Bank 1

<u>Phase</u>	<u>Walk</u>			<u>Don't Walk</u>			<u>Min Initial</u>			<u>Veh Ext</u>			<u>Max Limit</u>			<u>Max 2</u>			<u>Yellow</u>	<u>Red</u>
	1	2	3	1	2	3	1	2	3	1	2	3	1	2	3	1	2	3		
1 -	0	0	0	0	0	0	0	0	0	0	0	0	0	0	0	0	0	0	0	0
2 SWT	0	0	0	0	0	0	14	14	14	1	1	1	25	21	25	0	21	25	4	2
3 PED	4	4	4	23	23	23	0	0	0	0	0	0	0	0	0	0	0	0	0	0
4 SET	0	0	0	0	0	0	7	7	7	3.5	-2.5	-2.5	12	12	15	50	45	45	4	2
5 -	0	0	0	0	0	0	0	0	0	0	0	0	0	0	0	0	0	0	0	0
6 NET	0	0	0	0	0	0	14	14	14	1	1	1	25	21	25	0	21	25	4	2
7 -	0	0	0	0	0	0	0	0	0	0	0	0	0	0	0	0	0	0	0	0
8 -	0	0	0	0	0	0	0	0	0	0	0	0	0	0	0	0	0	0	0	0

Last In Service Date: unknown

Permitted Phases	
	12345678
Default	-234-6--
External Permit 0	-234-6--
External Permit 1	--3-----
External Permit 2	-234-6--

TOD Schedule Report

for 3391: Dade Blvd&Michigan Av N

Print Date:
10/4/2021

Print Time:
4:32 PM

Current TOD Schedule	Plan	Cycle	Green Time								Ring Offset	Offset
			1 -	2 SWT	3 PED	4 SET	5 -	6 NET	7 -	8 -		
2		110	0	30	27	41	0	30	0	0	0	53
3		100	0	37	27	24	0	37	0	0	0	8
4		110	0	28	27	43	0	28	0	0	0	86
5		80	0	17	27	24	0	17	0	0	0	57
6		120	0	33	27	48	0	33	0	0	0	1
9		90	0	23	27	28	0	23	0	0	0	65
10		80	0	22	27	19	0	22	0	0	0	12
11		80	0	29	27	12	0	29	0	0	0	27
13		100	0	23	27	38	0	23	0	0	0	32
14		120	0	33	27	48	0	33	0	0	0	117
15		90	0	14	27	37	0	14	0	0	0	65
23		80	0	27	27	14	0	27	0	0	0	57

Local TOD Schedule		
Time	Plan	DOW
0000	Free	Su M T W Th F S
0600	13	M T W Th F
0700	2	M T W Th F
0700	13	Su S
0830	14	M T W Th F
1000	13	Su S
1315	14	M T W Th F
1500	4	F
1600	4	M T W Th
1830	13	M T W Th F
2000	14	Su F S
2200	Free	M T W Th

Current Time of Day Function			
Time	Function	Settings *	Day of Week
0000	TOD OUTPUTS	-----1	SuM T W ThF S
0000	TOD LOCAL MULTIFU	----4---	SuM T W ThF S
0100	TOD OUTPUTS	-----	SuM T W ThF S
0500	TOD LOCAL MULTIFU	-----	SuM T W ThF S
2200	TOD OUTPUTS	-----1	M T W ThF S

Local Time of Day Function			
Time	Function	Settings *	Day of Week
0000	TOD OUTPUTS	-----1	SuM T W ThF S
0000	TOD LOCAL MULTIFUNCT	----4---	SuM T W ThF S
0100	TOD OUTPUTS	-----	SuM T W ThF S
0500	TOD LOCAL MULTIFUNCT	-----	SuM T W ThF S
0700	TOD OUTPUTS	-----1	Su S
1000	TOD OUTPUTS	-----	Su S
2000	TOD OUTPUTS	-----1	Su S
2200	TOD OUTPUTS	-----1	M T W ThF S

* Settings
Blank - FREE - Phase Bank 1, Max 1
Blank - Plan - Phase Bank 1, Max 2
1 - Phase Bank 2, Max 1
2 - Phase Bank 2, Max 2
3 - Phase Bank 3, Max 1
4 - Phase Bank 3, Max 2
5 - EXTERNAL PERMIT 1
6 - EXTERNAL PERMIT 2
7 - X-PED OMIT
8 - TBA

No Calendar Defined/Enabled

TOD Schedule Report
for 3392: Alton Rd&Michigan Av

Print Date:
10/4/2021

Print Time:
4:33 PM

<u>Asset</u>	<u>Intersection</u>	<u>TOD Schedule</u>	<u>Op Mode</u>	<u>Plan #</u>	<u>Cycle</u>	<u>Offset</u>	<u>TOD Setting</u>	<u>Active PhaseBank</u>	<u>Active Maximum</u>
3392	Alton Rd&Michigan Av	DOW-2	TOD	[10] PRE-PM PEAK	150	118	N/A	1	Max 2

Splits

<u>PH 1</u>	<u>PH 2</u>	<u>PH 3</u>	<u>PH 4</u>	<u>PH 5</u>	<u>PH 6</u>	<u>PH 7</u>	<u>PH 8</u>
NBL	SBT	-	WBT	SBL	NBT	-	EBT
43	59	0	30	43	59	0	30

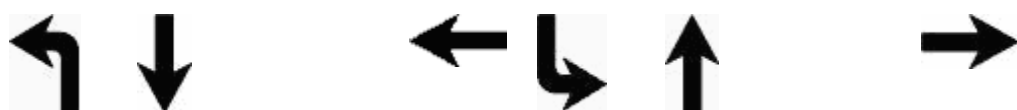

Active Phase Bank: Phase Bank 1

Phase	<u>Walk</u>			<u>Don't Walk</u>			<u>Min Initial</u>			<u>Veh Ext</u>			<u>Max Limit</u>			<u>Max 2</u>			<u>Yellow</u>	<u>Red</u>
	1	2	3	1	2	3	1	2	3	1	2	3	1	2	3	1	2	3		
1 NBL	0	0	0	0	0	0	5	5	5	6	6	6	12	12	12	100	100	10	3.7	2
2 SBT	7	7	7	12	12	12	14	14	14	1	1	1	20	20	20	0	0	0	4	2
3 -	0	0	0	0	0	0	0	0	0	0	0	0	0	0	0	0	0	0	0	0
4 WBT	0	0	0	0	0	0	7	7	7	2.5	-2.5	-2.5	12	12	12	50	50	50	4	2.3
5 SBL	0	0	0	0	0	0	5	5	5	6	6	6	12	12	12	100	100	10	3.7	2
6 NBT	0	0	0	0	0	0	14	14	14	1	1	1	20	20	20	0	0	0	4	2
7 -	0	0	0	0	0	0	0	0	0	0	0	0	0	0	0	0	0	0	0	0
8 EBT	7	7	7	23	23	23	7	7	7	2.5	-2.5	-2.5	12	12	12	50	50	50	4	2.3

Last In Service Date: unknown

Permitted Phases	
	12345678
Default	12-456-8
External Permit 0	12-456-8
External Permit 1	12-456-8
External Permit 2	12-456-8

TOD Schedule Report
for 3392: Alton Rd&Michigan Av

Print Date:
10/4/2021

Print Time:
4:33 PM

Current TOD Schedule	Plan	Cycle	Green Time								Ring Offset	Offset
			1 NBL	2 SBT	3 -	4 WBT	5 SBL	6 NBT	7 -	8 EBT		
1		100	15	39	0	28	15	39	0	28	0	8
3		120	15	57	0	30	15	57	0	30	0	81
5		150	33	69	0	30	33	69	0	30	0	6
6		160	45	69	0	28	45	69	0	28	0	8
10		150	43	59	0	30	43	59	0	30	0	118
13		130	23	59	0	30	23	59	0	30	0	45
19		120	14	58	0	30	14	58	0	30	0	50
20		140	23	69	0	30	23	69	0	30	0	96
21		140	17	75	0	30	17	75	0	30	0	0
22		120	7	65	0	30	7	65	0	30	0	42
25		140	45	49	0	28	45	49	0	28	0	5
26		200	50	104	0	28	50	104	0	28	0	13
27		180	45	89	0	28	45	89	0	28	0	141

Local TOD Schedule		
Time	Plan	DOW
0000	1	Su M T W Th F S
0600	3	Su M T W Th F S
0800	5	M T W Th F
0800	19	Su S
1000	20	Su S
1300	10	M T W Th F
1900	13	Su M T W Th F S
2000	22	Su S

Current Time of Day Function			
Time	Function	Settings *	Day of Week
0000	TOD OUTPUTS	-----	SuM T W ThF S
0000	TOD LOCAL MULTIFU	---4---	SuM T W ThF S
0500	TOD LOCAL MULTIFU	-----	SuM T W ThF S

Local Time of Day Function			
Time	Function	Settings *	Day of Week
0000	TOD OUTPUTS	-----	SuM T W ThF S
0000	TOD LOCAL MULTIFUNCT	---4---	SuM T W ThF S
0500	TOD LOCAL MULTIFUNCT	-----	SuM T W ThF S

* Settings
Blank - FREE - Phase Bank 1, Max 1
Blank - Plan - Phase Bank 1, Max 2
1 - Phase Bank 2, Max 1
2 - Phase Bank 2, Max 2
3 - Phase Bank 3, Max 1
4 - Phase Bank 3, Max 2
5 - EXTERNAL PERMIT 1
6 - EXTERNAL PERMIT 2
7 - X-PED OMIT
8 - TBA

No Calendar Defined/Enabled

SIGNAL OPERATING PLAN

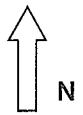

	Direction	NB		SB			EB		WB		Ped Heads				
Timing Phases	Head No.	1/6	6	5	2	2R	3/8	8	7/4	4	P2	P6	P4	P8	Movements/Display/Actuation
(1+5) N/SBLT Alton Rd (ACTUATED)	Dwell	R/<G	R	<G	R	R	R	R	R	R	DW	DW	DW	DW	
	(1+6)	R/<G	R	<Y	R	R	R	R	R	R	DW	DW	DW	DW	
	(2+5)	R/<Y	R	<G	R	R	R	R	R	R	DW	DW	DW	DW	
	(2+6)	R/<Y	R	<Y	R	R	R	R	R	R	DW	DW	DW	DW	
(2+5) NB Alton Rd (ACTUATED)	Dwell	R	R	<G	G	G	R	R	R	R	W/F	DW	DW	DW	
	(2+6)	R	R	<Y	G	G	R	R	R	R	DW	DW	DW	DW	
(1+6) Alton Rd US-1 (ACTUATED)	Dwell	<G/G	G	<R	R	R	R	R	R	R	DW	W/F	DW	DW	
	(2+6)	<Y/G	G	<R	R	R	R	R	R	R	DW	DW	DW	DW	
(2+6) N/SB Alton Rd (RECALL)	Dwell	G	G	<R	G	G	R	R	R	R	W/F	W/F	DW	DW	
	(3+7)	Y	Y	<R	Y	Y	R	R	R	R	DW	DW	DW	DW	
	(3+8)	Y	Y	<R	Y	Y	R	R	R	R	DW	DW	DW	DW	
	(7+4)	Y	Y	<R	Y	Y	R	R	R	R	DW	DW	DW	DW	
	(4+8)	Y	Y	<R	Y	Y	R	R	R	R	DW	DW	DW	DW	
	(1+5)	Y	Y	<R	Y	Y	R	R	R	R	DW	DW	DW	DW	
(3+7) NE/SWBLT Dade Blvd (ACTUATED)	Dwell	R	R	<R	R	R/G>	R/<G	R	R/<G	R	DW	DW	DW	DW	
	(3+8)	R	R	<R	R	R/G>	R/<G	R	R/<Y	R	DW	DW	DW	DW	
	(7+4)	R	R	<R	R	R/Y>	R/<Y	R	R/<G	R	DW	DW	DW	DW	
	(4+8)	R	R	<R	R	R/Y>	R/<Y	R	R/<Y	R	DW	DW	DW	DW	
	(1+5)	R	R	<R	R	R/Y>	R/<Y	R	R/<Y	R	DW	DW	DW	DW	
	(2+5)	R	R	<R	R	R/Y>	R/<Y	R	R/<Y	R	DW	DW	DW	DW	
	(1+6)	R	R	<R	R	R/Y>	R/<Y	R	R/<Y	R	DW	DW	DW	DW	
(3+8) NEB Dade Blvd (ACTUATED)	Dwell	R	R	<R	R	R/G>	<G/G	G	R	R	DW	DW	DW	W/F	
	(4+8)	R	R	<R	R	R/Y>	<Y/G	G	R	R	DW	DW	DW	DW	
	(1+5)	R	R	<R	R	R/Y>	Y/<Y	Y	R	R	DW	DW	DW	DW	
	(2+5)	R	R	<R	R	R/Y>	Y/<Y	Y	R	R	DW	DW	DW	DW	
	(1+6)	R	R	<R	R	R/Y>	Y/<Y	Y	R	R	DW	DW	DW	DW	
(7+4) SWB Dade Blvd (ACTUATED)	Dwell	R	R	<R	R	R	R	R	<G/G	G	DW	DW	W/F	DW	
	(4+8)	R	R	<R	R	R	R	R	<Y/G	G	DW	DW	DW	DW	
	(1+5)	R	R	<R	R	R	R	R	Y/<Y	Y	DW	DW	DW	DW	
	(1+6)	R	R	<R	R	R	R	R	Y/<Y	Y	DW	DW	DW	DW	
	(2+5)	R	R	<R	R	R	R	R	Y/<Y	Y	DW	DW	DW	DW	
(4+8) NE/SWB Dade Blvd (ACTUATED)	Dwell	R	R	<R	R	R	G	G	G	G	DW	DW	W/F	W/F	
	(1+5)	R	R	<R	R	R	Y	Y	Y	Y	DW	DW	DW	DW	
	(1+6)	R	R	<R	R	R	Y	Y	Y	Y	DW	DW	DW	DW	
	(2+6)	R	R	<R	R	R	Y	Y	Y	Y	DW	DW	DW	DW	

Flashing Operation

FY

FY

F<R

FY

FY

FR

FR

FR

FR

Page 1 of 1

Miami-Dade County Public Works Department

Drawn
WILLIAM RIVERA PAZ

Date
6/16/2015

Alton Rd & Dade Blvd

Checked
H. Hernandez

Date
6/16/15

Placed in Service

Date 7/27/15

By ENT

Phasing No.

8

Asset Number

2648

SIGNAL OPERATING PLAN



Timing Phases	Direction	NB		SB		EB		WB		Ped Heads		Movements/Display/Actuation
	Head No.	1/6	6	2	3	3/8	7/4	4	P2	P8		
(1+6) SB ALTON RD (RECALL)	Dwell	<G/G	G		R	R	R	R	R	DW	DW	
	(2+6)	<Y/G	G		R	R	R	R	R	DW	DW	
	clear											
	to											
(2+6) N/SB ALTON RD (RECALL)	Dwell	G	G		G	R	R	R	R	W/F	DW	
	(3)	Y	Y		Y	R	R	R	R	DW	DW	
	(4)	Y	Y		Y	R	R	R	R	DW	DW	
	clear											
(3) EB 20 Street (ACTUATED)	Dwell	R	R		R	<G	<G/G	R	R	DW	W/F	
	(4)	R	R		R	Y	Y	R	R	DW	DW	
	(1+6)	R	R		R	Y	Y	R	R	DW	DW	
	(2+6)	R	R		R	Y	Y	R	R	DW	DW	
(4) WB 20 Street (ACTUATED)	Dwell	R	R		R	R	R	<G/G	G	DW	DW	
	(1+6)	R	R		R	R	R	Y	Y	DW	DW	
	(2+6)	R	R		R	R	R	Y	Y	DW	DW	
	clear											

Flashing Operation FY FY FY FR FR FR FR Page 1 of 1

Miami-Dade County Public Works Department

Drawn WILLIAM RIVERA PAZ	Date 2/3/2015	ALTON RD & 20 ST			
Checked <i>H. Hernandez-DT2</i>	Date 2/12/15	Placed in Service Date 2/27/15		By <i>EEC</i>	Phasing No. 7
					Asset Number 3276

SIGNAL OPERATING PLAN



Direction	WB	FB	SB		Ped Heads			Movements/Display/Actuation	
ing Phases	Head No.	2	2A	6	8	8A	P2		
+6 /w DE BLVD RECAL	Dwell	G	→	G	R	R	DW	2A ←	
	Clear to	3	G	→	G	R	R	DW	2 ←
		4	Y	→	Y	R	R	DW	→ 6
3 ED CROSS E/W	Dwell	G	→	G	R	R	W/F	P2	
	Clear to	4	Y	→	Y	R	R	DW	2 ←
		2+6	G	→	G	R	R	DW	→ 6
TUATED	Dwell	R	→	R	G	G	DW		
	Clear to	2+6	R	→	R	Y	Y	DW	
TUATED		Dwell							
	Clear to								
TUATED		Dwell							
	Clear to								

Phasing Operation	FY	FY	FY	FR	FR	FR	Page 1 of 1
Miami-Dade County Public Works Department							
Zancillon		Date	DABE BLVD & MICHIGAN AV				
		Date	Placed in Service		Phasing No.		Asset Number
		7/29/04	Date 7/29/04	By SHOP	4		3391

Miami-Dade County Public Works Department Signalization Operation Definition and Timing Report

Location: Alton Rd&Michigan Av Asset Number: 3392 Page Name: _____ Last Change: _____

Section: 274 Alton / Dade Blvd & 1st Movements Assignable Inputs DA: _____ 11/6/2019 12:38
 Assignable Outputs DA: _____ 11/6/2019 12:38
 Assignable Outputs Plans DA: _____ 11/6/2019 12:38
 Basic Timing Phase Bank 1: _____ 11/6/2019 14:52
 Basic Timing Phase Bank 2: _____ 11/6/2019 14:52
 Basic Timing Phase Bank 3: _____ 11/6/2019 14:52
 Configuration Parameters DA: _____ 11/6/2019 14:53
 Configuration Setup: _____ 11/6/2019 14:54
 Configuration Timers DA: _____ 11/6/2019 12:38
 Coordination All Plans DA: _____ 11/6/2019 14:50
 Coordination Parameters: _____ 11/6/2019 12:38
 Coordination Settings: _____ 11/6/2019 12:38
 Coordination Timing: _____ 11/6/2019 14:47
 Daylight Savings: _____ 11/6/2019 12:38
 Detector Parameters: _____ 11/6/2019 12:38
 Detectors: _____ 11/6/2019 14:36
 Holiday Dates DA: _____ 11/6/2019 12:38
 Holiday Events DA: _____ 11/6/2019 12:38
 Holiday TOD Functions DA: _____ 11/6/2019 12:38
 Overlaps DA: _____ 11/6/2019 12:38
 Preemption Parameters: _____ 11/6/2019 12:38
 Preemption Special Events Table 1: _____ 11/6/2019 12:38
 Preemption Special Events Table 2: _____ 11/6/2019 12:38
 Redirect Outputs DA: _____ 11/6/2019 12:38
 TOD Functions: _____ 11/6/2019 12:38
 TOD Schedule: _____ 11/6/2019 12:38
 Last Update: _____ 11/6/2019 14:54

Preemption Device: No

Type HW/SW

Equipment Type: BI233DA

Cabinet Type: 552

Addresses

Drop: 5

Phone Number: -

Preemption

EV (Local): _____ RR(Local): _____ Route (remote): _____ Bridge: _____

Comments

Last Updated by: e300974

Zone Assignments	
Zone Category	Zone
Engineering	03 - (MH) SE Miami
Maintenance	1 - Maint-M Beach/ DTA
Systems	Sys-Central
Electronic Shop	Shop-Dade County

Approved by: *E. A. Espinal* Approval Date/Time: 3/18/2016 8:54 11/8/19

In Service Date: _____ ATMS Migration Date: 5/12/2008

SOP/Phasing No.: _____ 4

DETECTION RACK CONNECTION STANDARDIZATION FORM FOR LOOPS DETECTION
FOR MIAMI-DADE COUNTY TRAFFIC SIGNALS 552 & 660 CABINETS

ASSET ID: 3392

LOCATION: ALTON RD & MICHIGAN AV

MIAMI-DADE COUNTY 552 & 660 DETECTOR ASSIGNMENTS

DETECTOR	DIRECTION	PHASE / MOVEMENT	DECT. RACK SLOT	LOOP NO.	LOOP LABEL	TERMINALS
D1	NBL	1	1	5	L-1	TBA4-(1,3)
D2						TBA4-(4,6)
D3			2			TBA4-(7,9)
D4						TBA4-(10,12)
D5						TBA4-(13,15)
D6			3			TBA4-(16,18)
D7	WBT	4	4	4	L-4	TBA3-(1,3)
D8						TBA3-(4,6)
D9	SBL	5	5	2	L5	TBA3-(7,9)
D10	SBL	5	5	3	L-5	TBA3-(10,12)
D11			6			TBA3-(13,15)
D12						TBA3-(16,18)
D13			7			TBA2-(1,3)
D14						TBA2-(4,6)
D15	EBT	8	8	1	L-8	TBA2-(7,9)
D16						TBA2-(10,12)
D17						TBA2-(13,15)
D18			9			TBA2-(16,18)

REMARKS:
 * This chart shall be used to achieve a standard connection for loops for each cabinet detection rack.
 * All data shown is based on signal plan, field survey, or controller cabinet schematics.
 * Loops are numbered clockwise beginning at the controller site and shall be label separate from each other.

LOOP: D1

CABINET:

PHASE / MOVEMENT: 1

INTERSECTION DETECTION DRAWING

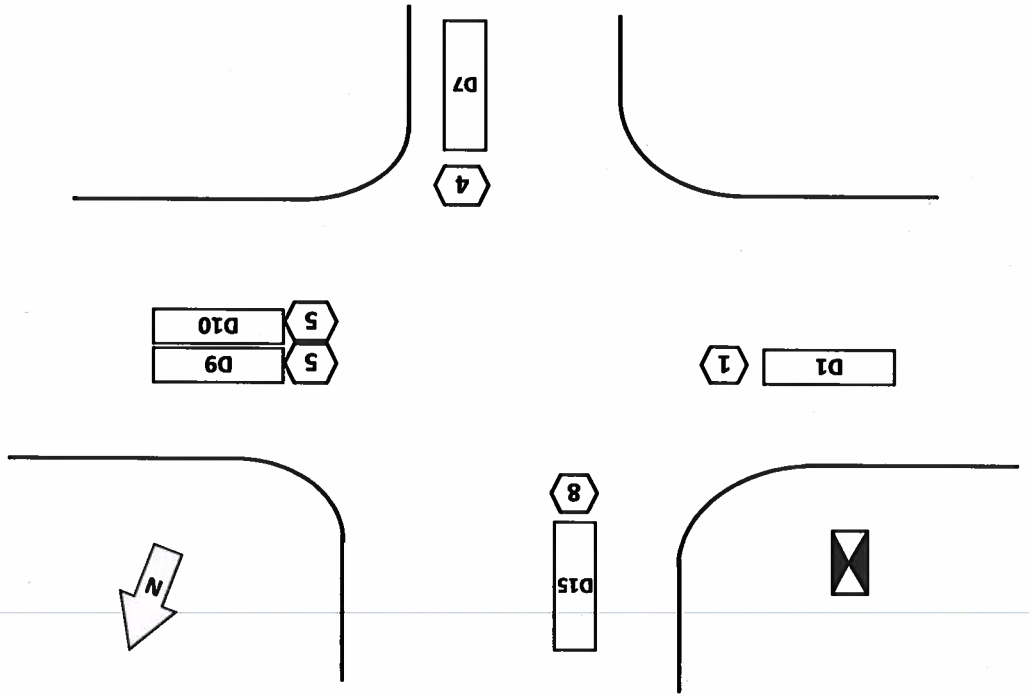

MIAMI-DADE COUNTY TRAFFIC SIGNAL CABINETS 552 & 660 DETECTOR RACK CHANNEL ASSIGNMENTS

MOVEMENT	DECT. SLOT	CHANNEL #	CHANNEL #
1	1	1	1
2	2	2	2
3	3	3	3
4	4	4	4
5	5	5	5
6	6	6	6
7	7	7	7
8	8	8	8
9	9	9	9
10	10	10	10
11	11	11	11
12	12	12	12
13	13	13	13
14	14	14	14
15	15	15	15
16	16	16	16
17	17	17	17
18	18	18	18

NOTES:

2022 PEAK SEASON FACTOR CATEGORY REPORT - REPORT TYPE: ALL
 CATEGORY: 8700 MIAMI-DADE NORTH

WEEK	DATES	SF	MOCF: 0.96 PSCF
1	01/01/2022 - 01/01/2022	1.06	1.10
2	01/02/2022 - 01/08/2022	1.04	1.08
3	01/09/2022 - 01/15/2022	1.02	1.06
4	01/16/2022 - 01/22/2022	1.01	1.05
5	01/23/2022 - 01/29/2022	1.00	1.04
6	01/30/2022 - 02/05/2022	0.98	1.02
7	02/06/2022 - 02/12/2022	0.97	1.01
* 8	02/13/2022 - 02/19/2022	0.96	1.00
* 9	02/20/2022 - 02/26/2022	0.96	1.00
*10	02/27/2022 - 03/05/2022	0.96	1.00
*11	03/06/2022 - 03/12/2022	0.96	1.00
*12	03/13/2022 - 03/19/2022	0.96	1.00
*13	03/20/2022 - 03/26/2022	0.96	1.00
*14	03/27/2022 - 04/02/2022	0.96	1.00
*15	04/03/2022 - 04/09/2022	0.96	1.00
*16	04/10/2022 - 04/16/2022	0.95	0.99
*17	04/17/2022 - 04/23/2022	0.96	1.00
*18	04/24/2022 - 04/30/2022	0.96	1.00
*19	05/01/2022 - 05/07/2022	0.97	1.01
*20	05/08/2022 - 05/14/2022	0.97	1.01
21	05/15/2022 - 05/21/2022	0.98	1.02
22	05/22/2022 - 05/28/2022	0.99	1.03
23	05/29/2022 - 06/04/2022	0.99	1.03
24	06/05/2022 - 06/11/2022	1.00	1.04
25	06/12/2022 - 06/18/2022	1.01	1.05
26	06/19/2022 - 06/25/2022	1.01	1.05
27	06/26/2022 - 07/02/2022	1.01	1.05
28	07/03/2022 - 07/09/2022	1.02	1.06
29	07/10/2022 - 07/16/2022	1.02	1.06
30	07/17/2022 - 07/23/2022	1.02	1.06
31	07/24/2022 - 07/30/2022	1.02	1.06
32	07/31/2022 - 08/06/2022	1.01	1.05
33	08/07/2022 - 08/13/2022	1.01	1.05
34	08/14/2022 - 08/20/2022	1.01	1.05
35	08/21/2022 - 08/27/2022	1.03	1.07
36	08/28/2022 - 09/03/2022	1.04	1.08
37	09/04/2022 - 09/10/2022	1.05	1.09
38	09/11/2022 - 09/17/2022	1.07	1.11
39	09/18/2022 - 09/24/2022	1.05	1.09
40	09/25/2022 - 10/01/2022	1.03	1.07
41	10/02/2022 - 10/08/2022	1.01	1.05
42	10/09/2022 - 10/15/2022	0.99	1.03
43	10/16/2022 - 10/22/2022	1.00	1.04
44	10/23/2022 - 10/29/2022	1.01	1.05
45	10/30/2022 - 11/05/2022	1.01	1.05
46	11/06/2022 - 11/12/2022	1.02	1.06
47	11/13/2022 - 11/19/2022	1.03	1.07
48	11/20/2022 - 11/26/2022	1.04	1.08
49	11/27/2022 - 12/03/2022	1.05	1.09
50	12/04/2022 - 12/10/2022	1.05	1.09
51	12/11/2022 - 12/17/2022	1.06	1.10
52	12/18/2022 - 12/24/2022	1.04	1.08
53	12/25/2022 - 12/31/2022	1.02	1.06

* PEAK SEASON

FLORIDA DEPARTMENT OF TRANSPORTATION
 TRANSPORTATION STATISTICS OFFICE
 2022 HISTORICAL AADT REPORT

COUNTY: 87 - MIAMI-DADE

SITE: 0012 - SR 907/ALTON RD, 200' N OF 20 ST (MIAMI BEACH)

YEAR	AADT		DIRECTION 1		DIRECTION 2	*K FACTOR	D FACTOR	T FACTOR
2022	44500	C	N 21500		S 23000	9.00	54.70	2.80
2021	49000	C	N 24000		S 25000	9.00	54.30	5.40
2020	36500	C	N 17000		S 19500	9.00	54.20	2.70
2019	43000	C	N 23000		S 20000	9.00	54.60	3.40
2018	49500	C	N 24500		S 25000	9.00	54.30	4.80
2017	47000	C	N 22500		S 24500	9.00	55.00	3.00
2016	46000	C	N 22500		S 23500	9.00	54.50	3.70
2015	46000	C	N 22500		S 23500	9.00	54.70	3.20
2014	47500	S	N 22000		S 25500	9.00	54.50	2.50
2013	47500	F	N 22000		S 25500	9.00	52.40	2.50
2012	48500	C	N 22500		S 26000	9.00	55.70	2.50
2011	47000	C	N 22500		S 24500	9.00	55.10	3.50
2010	46000	C	N 23000		S 23000	8.98	54.08	3.50
2009	47000	C	N 23500		S 23500	8.99	53.24	3.90
2008	46500	C	N 23000		S 23500	9.09	55.75	2.10
2007	47500	C	N 23000		S 24500	8.01	54.34	2.20

AADT FLAGS: C = COMPUTED; E = MANUAL ESTIMATE; F = FIRST YEAR ESTIMATE
 S = SECOND YEAR ESTIMATE; T = THIRD YEAR ESTIMATE; R = FOURTH YEAR ESTIMATE
 V = FIFTH YEAR ESTIMATE; 6 = SIXTH YEAR ESTIMATE; X = UNKNOWN

*K FACTOR: STARTING WITH YEAR 2011 IS STANDARDK, PRIOR YEARS ARE K30 VALUES

FLORIDA DEPARTMENT OF TRANSPORTATION
 TRANSPORTATION STATISTICS OFFICE
 2022 HISTORICAL AADT REPORT

COUNTY: 87 - MIAMI-DADE

SITE: 2542 - SR 907/ALTON RD, 200' S OF VENETIAN CSWY

YEAR	AADT		DIRECTION 1		DIRECTION 2	*K FACTOR	D FACTOR	T FACTOR
2022	26000	C	N 13000		S 13000	9.00	54.70	4.80
2021	32500	C	N 13500		S 19000	9.00	54.30	2.90
2020	27500	C	N 14000		S 13500	9.00	54.20	5.60
2019	35000	F	N 17500		S 17500	9.00	54.60	3.50
2018	35000	C	N 17500		S 17500	9.00	54.30	3.50
2017	33000	C	N 16500		S 16500	9.00	55.00	2.80
2016	30000	C	N 15000		S 15000	9.00	54.50	5.90
2015	41000	C	N 21000		S 20000	9.00	54.70	1.60
2014	30500	F	N 14000		S 16500	9.00	54.50	7.60
2013	30500	C	N 14000		S 16500	9.00	52.40	7.60
2012	37000	C	N 19000		S 18000	9.00	55.70	7.50
2011	39500	C	N 19000		S 20500	9.00	55.10	1.50
2010	39000	C	N 20000		S 19000	8.98	54.08	1.50
2009	38500	C	N 19000		S 19500	8.99	53.24	6.20
2008	37500	C	N 17500		S 20000	9.09	55.75	4.80
2007	39500	C	N 18500		S 21000	8.01	54.34	5.20

AADT FLAGS: C = COMPUTED; E = MANUAL ESTIMATE; F = FIRST YEAR ESTIMATE
 S = SECOND YEAR ESTIMATE; T = THIRD YEAR ESTIMATE; R = FOURTH YEAR ESTIMATE
 V = FIFTH YEAR ESTIMATE; 6 = SIXTH YEAR ESTIMATE; X = UNKNOWN

*K FACTOR: STARTING WITH YEAR 2011 IS STANDARDK, PRIOR YEARS ARE K30 VALUES

FLORIDA DEPARTMENT OF TRANSPORTATION
 TRANSPORTATION STATISTICS OFFICE
 2022 HISTORICAL AADT REPORT

COUNTY: 87 - MIAMI-DADE

SITE: 8350 - VENETIAN CSWY, 200' EAST OF WEST AVENUE

YEAR	AADT		DIRECTION 1		DIRECTION 2	*K FACTOR	D FACTOR	T FACTOR	
2022	9700	C	E	3100	W	6600	9.00	54.70	2.20
2021	12000	C	E	5600	W	6400	9.00	54.30	1.90
2020	11600	C	E	5200	W	6400	9.00	54.20	1.60
2019	14000	C	E	6900	W	7100	9.00	54.60	2.90
2018	12400	C	E	5900	W	6500	9.00	54.30	2.60
2017	13300	F	E	6600	W	6700	9.00	55.00	2.40
2016	12900	C	E	6400	W	6500	9.00	54.50	2.40
2015	14400	C	E	6200	W	8200	9.00	54.70	12.80
2014	5100	F	E	2100	W	3000	9.00	54.50	11.70
2013	5100	C	E	2100	W	3000	9.00	52.40	16.20
2012	5400	F	E	2500	W	2900	9.00	55.70	16.00
2011	5400	C	E	2500	W	2900	9.00	55.10	14.70

AADT FLAGS: C = COMPUTED; E = MANUAL ESTIMATE; F = FIRST YEAR ESTIMATE
 S = SECOND YEAR ESTIMATE; T = THIRD YEAR ESTIMATE; R = FOURTH YEAR ESTIMATE
 V = FIFTH YEAR ESTIMATE; 6 = SIXTH YEAR ESTIMATE; X = UNKNOWN

*K FACTOR: STARTING WITH YEAR 2011 IS STANDARDK, PRIOR YEARS ARE K30 VALUES

Traffic Trends - V03.a

SR 907/ALTON RD -- 200' N OF 20 ST (MIAMI BEACH)

FIN#	0
Location	1

County:	MIAMI-DADE
Station #:	0012
Highway:	SR 907/ALTON RD

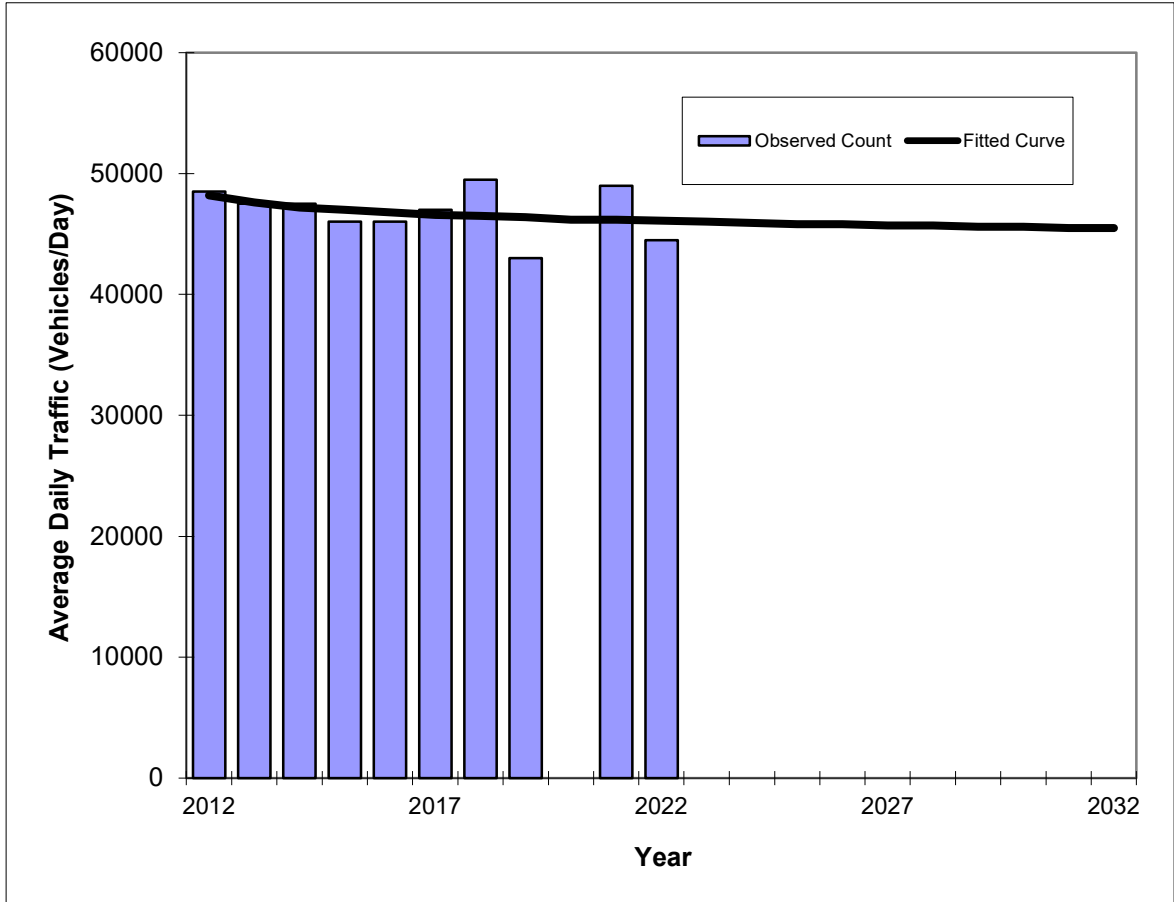

Year	Traffic (ADT/AADT)	
	Count*	Trend**
2012	48500	48200
2013	47500	47600
2014	47500	47200
2015	46000	47000
2016	46000	46800
2017	47000	46600
2018	49500	46500
2019	43000	46400
2020	N/A	N/A
2021	49000	46200
2022	44500	46100
2023 Opening Year Trend		
2023	N/A	46000
2024 Mid-Year Trend		
2024	N/A	45900
2026 Design Year Trend		
2026	N/A	45800
TRANPLAN Forecasts/Trends		

Trend R-squared:	11.33%
Compounded Annual Historic Growth Rate:	-0.44%
Compounded Growth Rate (2022 to Design Year):	-0.16%
Printed:	26-Aug-23
Decaying Exponential Growth Option	

*Axle-Adjusted

Traffic Trends - V03.a

SR 907/ALTON RD -- 200' N OF 20 ST (MIAMI BEACH)

FIN#	0
Location	1

County:	MIAMI-DADE
Station #:	0012
Highway:	SR 907/ALTON RD

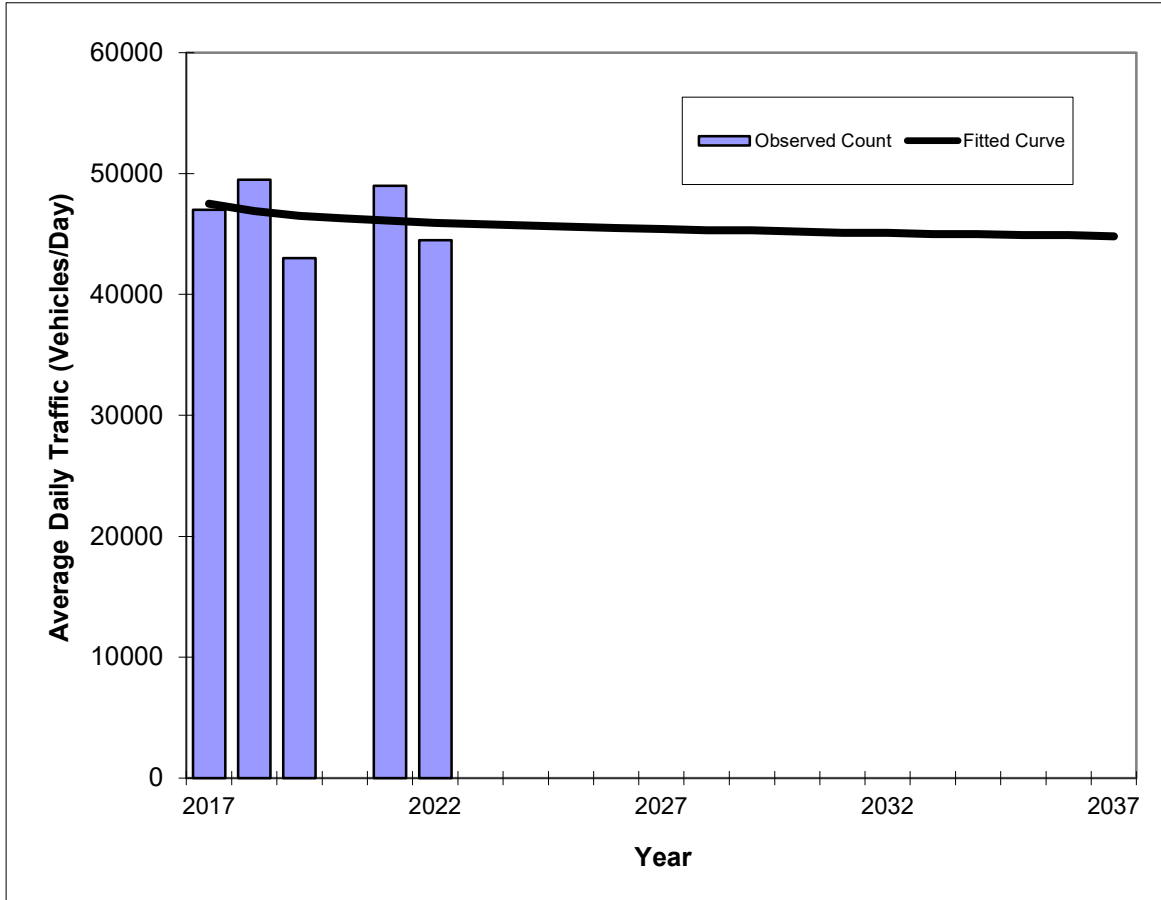

Year	Traffic (ADT/AADT)	
	Count*	Trend**
2017	47000	47500
2018	49500	46900
2019	43000	46500
2020	N/A	N/A
2021	49000	46100
2022	44500	45900
2023 Opening Year Trend		
2023	N/A	45800
2024 Mid-Year Trend		
2024	N/A	45700
2026 Design Year Trend		
2026	N/A	45500
TRANPLAN Forecasts/Trends		

Trend R-squared:	5.13%
Compounded Annual Historic Growth Rate:	-0.68%
Compounded Growth Rate (2022 to Design Year):	-0.22%
Printed:	26-Aug-23
Decaying Exponential Growth Option	

*Axle-Adjusted

Traffic Trends - V03.a

SR 907/ALTON RD -- 200' N OF 20 ST (MIAMI BEACH)

FIN#	0
Location	1

County:	MIAMI-DADE
Station #:	0012
Highway:	SR 907/ALTON RD

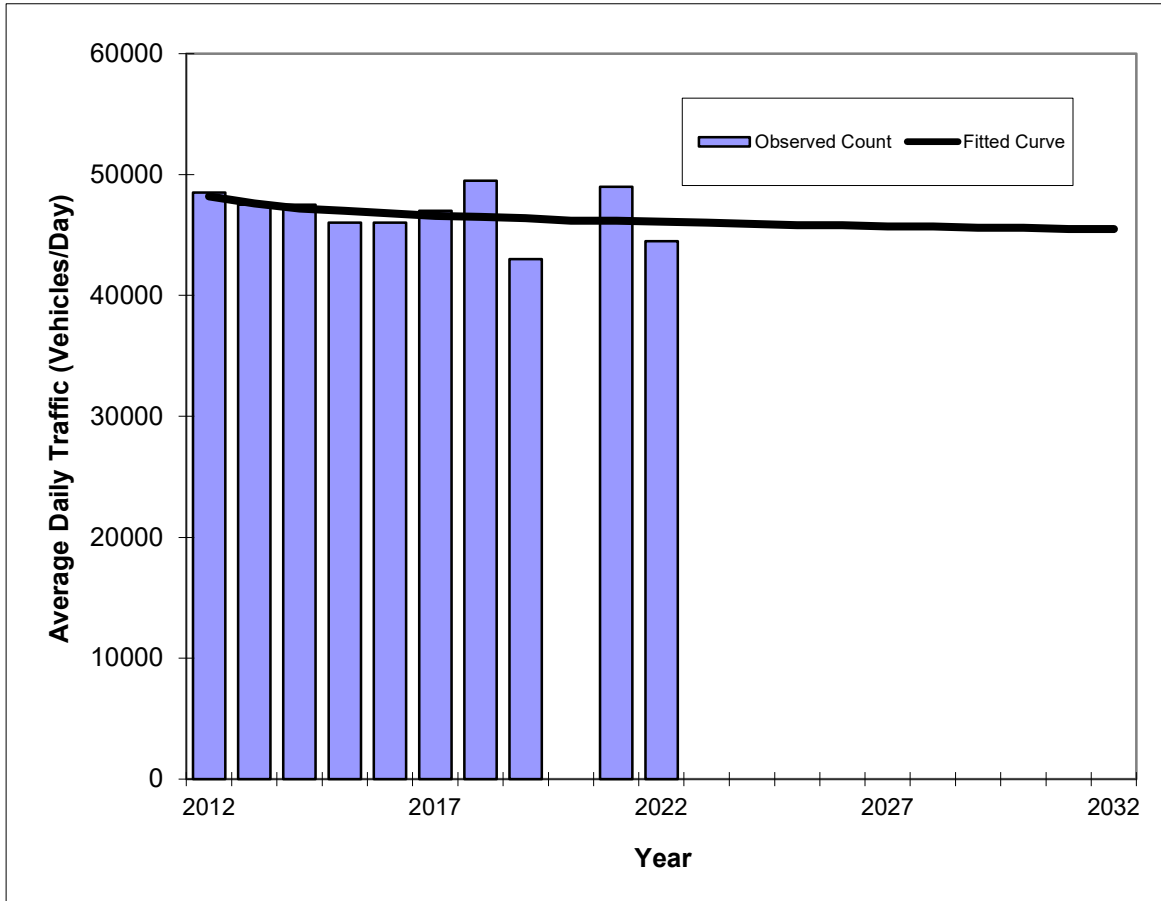

Year	Traffic (ADT/AADT)	
	Count*	Trend**
2012	48500	48200
2013	47500	47600
2014	47500	47200
2015	46000	47000
2016	46000	46800
2017	47000	46600
2018	49500	46500
2019	43000	46400
2020	N/A	N/A
2021	49000	46200
2022	44500	46100
2023 Opening Year Trend		
2023	N/A	46000
2024 Mid-Year Trend		
2024	N/A	45900
2026 Design Year Trend		
2026	N/A	45800
TRANPLAN Forecasts/Trends		

Trend R-squared:	9.78%
Compounded Annual Historic Growth Rate:	-0.44%
Compounded Growth Rate (2022 to Design Year):	-0.16%
Printed:	26-Aug-23
Exponential Growth Option	

*Axle-Adjusted

Traffic Trends - V03.a

SR 907/ALTON RD -- 200' N OF 20 ST (MIAMI BEACH)

FIN#	0
Location	1

County:	MIAMI-DADE
Station #:	0012
Highway:	SR 907/ALTON RD

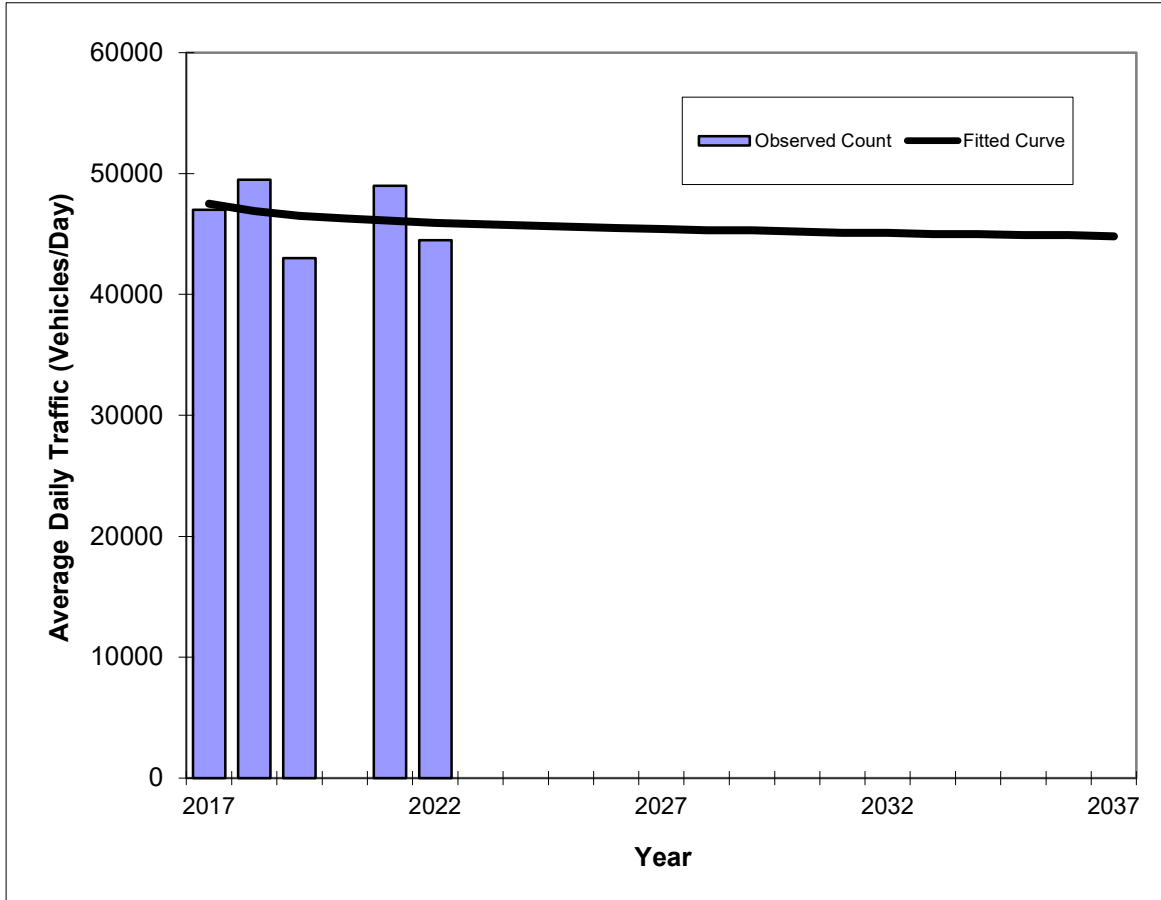

Year	Traffic (ADT/AADT)	
	Count*	Trend**
2017	47000	47500
2018	49500	46900
2019	43000	46500
2020	N/A	N/A
2021	49000	46100
2022	44500	45900
2023 Opening Year Trend		
2023	N/A	45800
2024 Mid-Year Trend		
2024	N/A	45700
2026 Design Year Trend		
2026	N/A	45500
TRANPLAN Forecasts/Trends		

Trend R-squared:	4.96%
Compounded Annual Historic Growth Rate:	-0.68%
Compounded Growth Rate (2022 to Design Year):	-0.22%
Printed:	26-Aug-23
Exponential Growth Option	

*Axle-Adjusted

Traffic Trends - V03.a

SR 907/ALTON RD -- 200' N OF 20 ST (MIAMI BEACH)

FIN#	0
Location	1

County:	MIAMI-DADE
Station #:	0012
Highway:	SR 907/ALTON RD

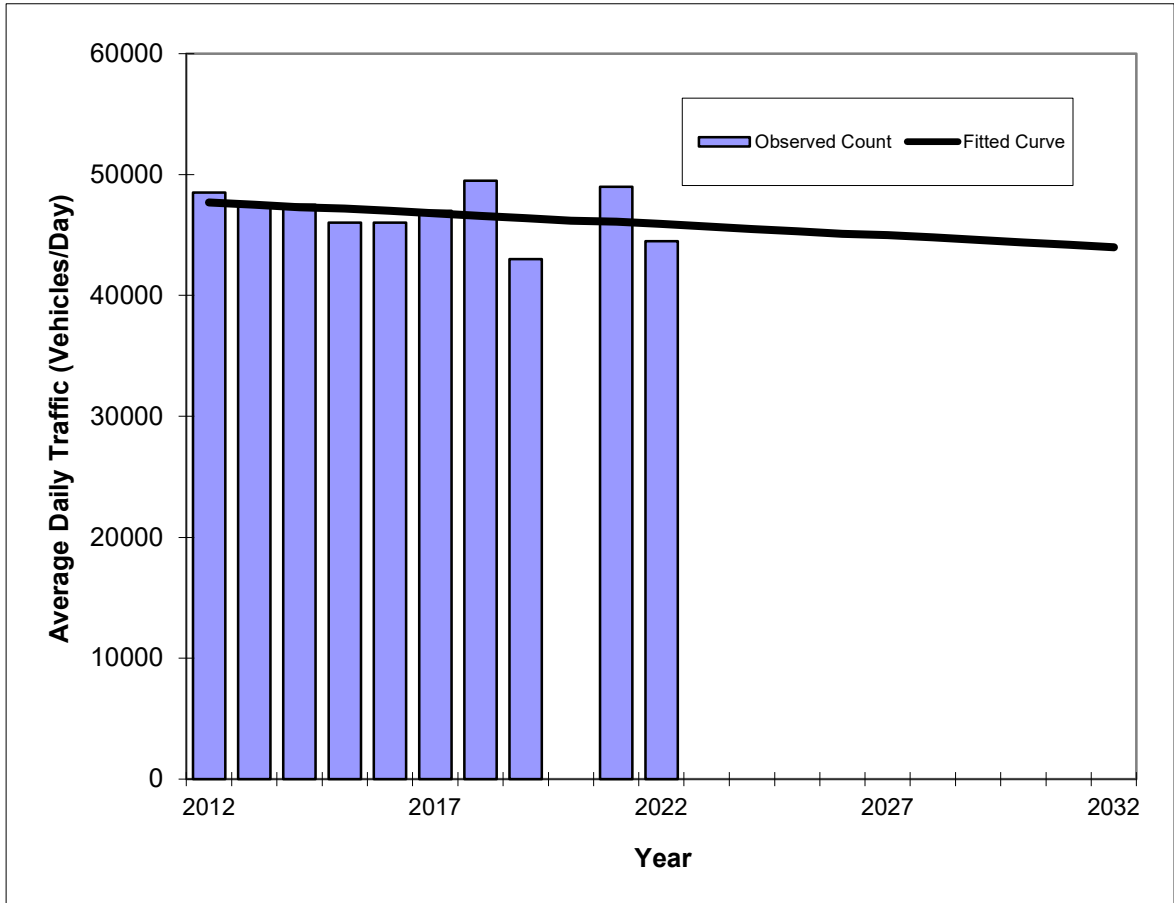

Year	Traffic (ADT/AADT)	
	Count*	Trend**
2012	48500	47700
2013	47500	47500
2014	47500	47300
2015	46000	47200
2016	46000	47000
2017	47000	46800
2018	49500	46600
2019	43000	46400
2020	N/A	N/A
2021	49000	46100
2022	44500	45900
2023 Opening Year Trend		
2023	N/A	45700
2024 Mid-Year Trend		
2024	N/A	45500
2026 Design Year Trend		
2026	N/A	45100
TRANPLAN Forecasts/Trends		

** Annual Trend Increase:	-184
Trend R-squared:	9.18%
Trend Annual Historic Growth Rate:	-0.38%
Trend Growth Rate (2022 to Design Year):	-0.44%
Printed:	26-Aug-23
Straight Line Growth Option	

*Axle-Adjusted

Traffic Trends - V03.a

SR 907/ALTON RD -- 200' N OF 20 ST (MIAMI BEACH)

FIN#	0
Location	1

County:	MIAMI-DADE
Station #:	0012
Highway:	SR 907/ALTON RD

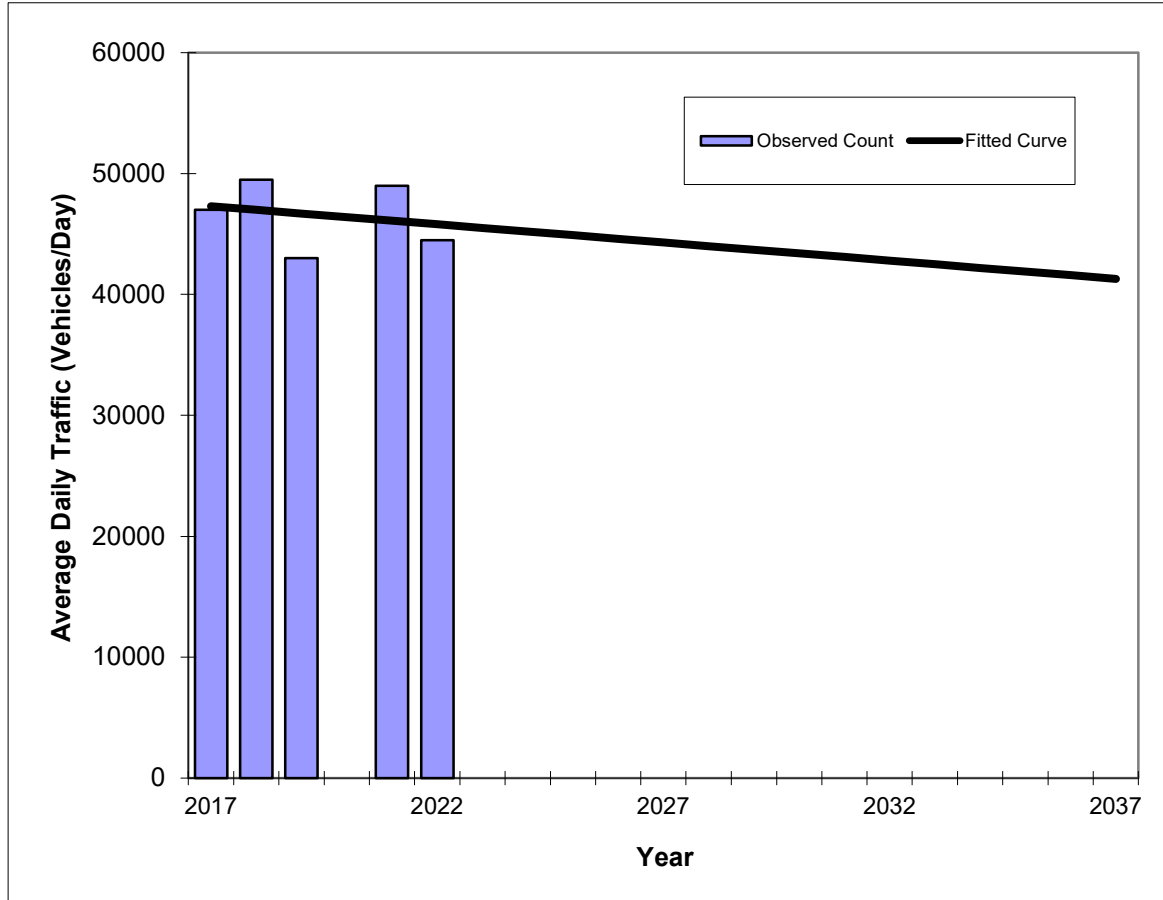

Year	Traffic (ADT/AADT)	
	Count*	Trend**
2017	47000	47300
2018	49500	47000
2019	43000	46700
2020	N/A	N/A
2021	49000	46100
2022	44500	45800
2023 Opening Year Trend		
2023	N/A	45500
2024 Mid-Year Trend		
2024	N/A	45200
2026 Design Year Trend		
2026	N/A	44600
TRANPLAN Forecasts/Trends		

** Annual Trend Increase:	-302
Trend R-squared:	4.96%
Trend Annual Historic Growth Rate:	-0.63%
Trend Growth Rate (2022 to Design Year):	-0.66%
Printed:	26-Aug-23

Straight Line Growth Option

*Axle-Adjusted

Traffic Trends - V03.a
SR 907/ALTON RD -- 200' S OF VENETIAN CSWY

FIN#	0
Location	2

County:	MIAMI-DADE
Station #:	2542
Highway:	SR 907/ALTON RD

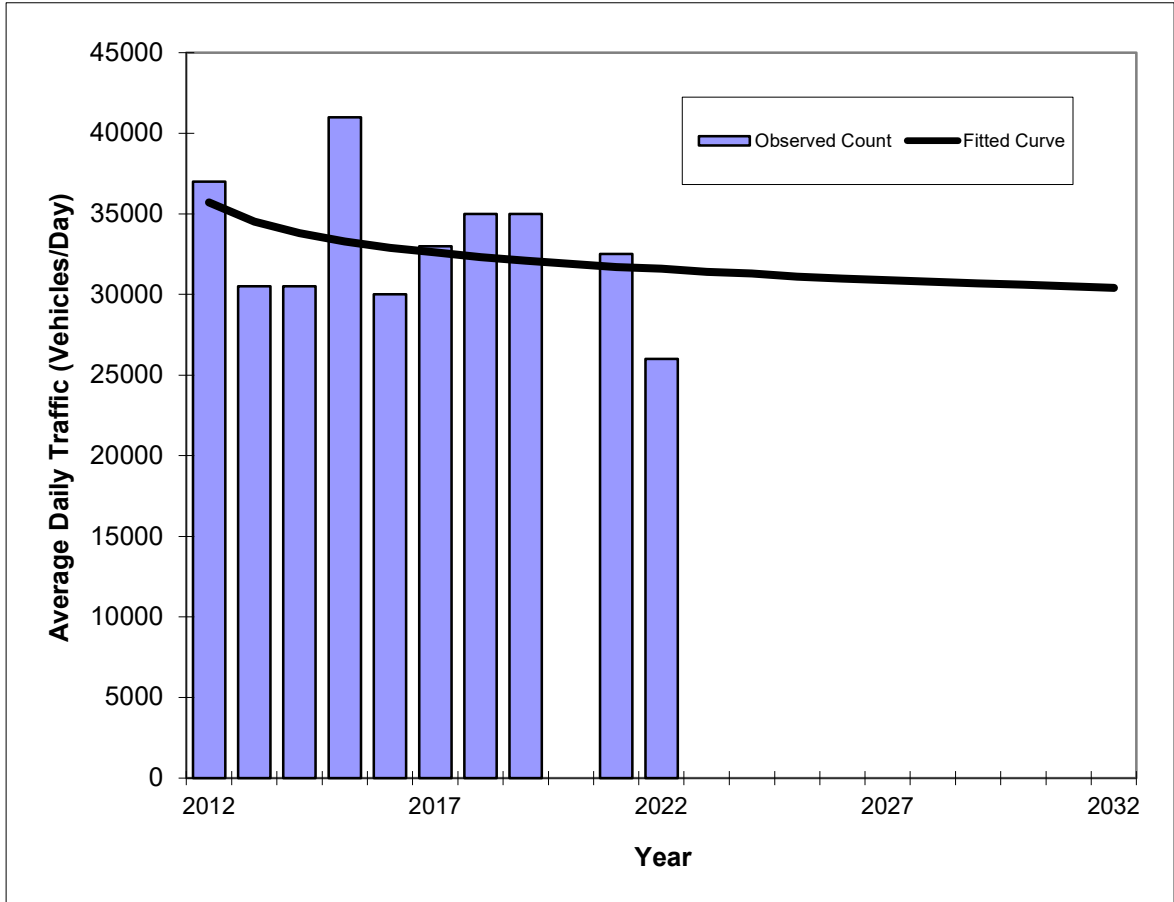

Year	Traffic (ADT/AADT)	
	Count*	Trend**
2012	37000	35700
2013	30500	34500
2014	30500	33800
2015	41000	33300
2016	30000	32900
2017	33000	32600
2018	35000	32300
2019	35000	32100
2020	N/A	N/A
2021	32500	31700
2022	26000	31600
2023 Opening Year Trend		
2023	N/A	31400
2024 Mid-Year Trend		
2024	N/A	31300
2026 Design Year Trend		
2026	N/A	31000
TRANPLAN Forecasts/Trends		

Trend R-squared:	9.63%
Compounded Annual Historic Growth Rate:	-1.21%
Compounded Growth Rate (2022 to Design Year):	-0.48%
Printed:	26-Aug-23
Decaying Exponential Growth Option	

*Axle-Adjusted

Traffic Trends - V03.a

VENETIAN CSWY -- 200' EAST OF WEST AVENUE

FIN#	0
Location	3

County:	MIAMI-DADE
Station #:	8350
Highway:	VENETIAN CSWY

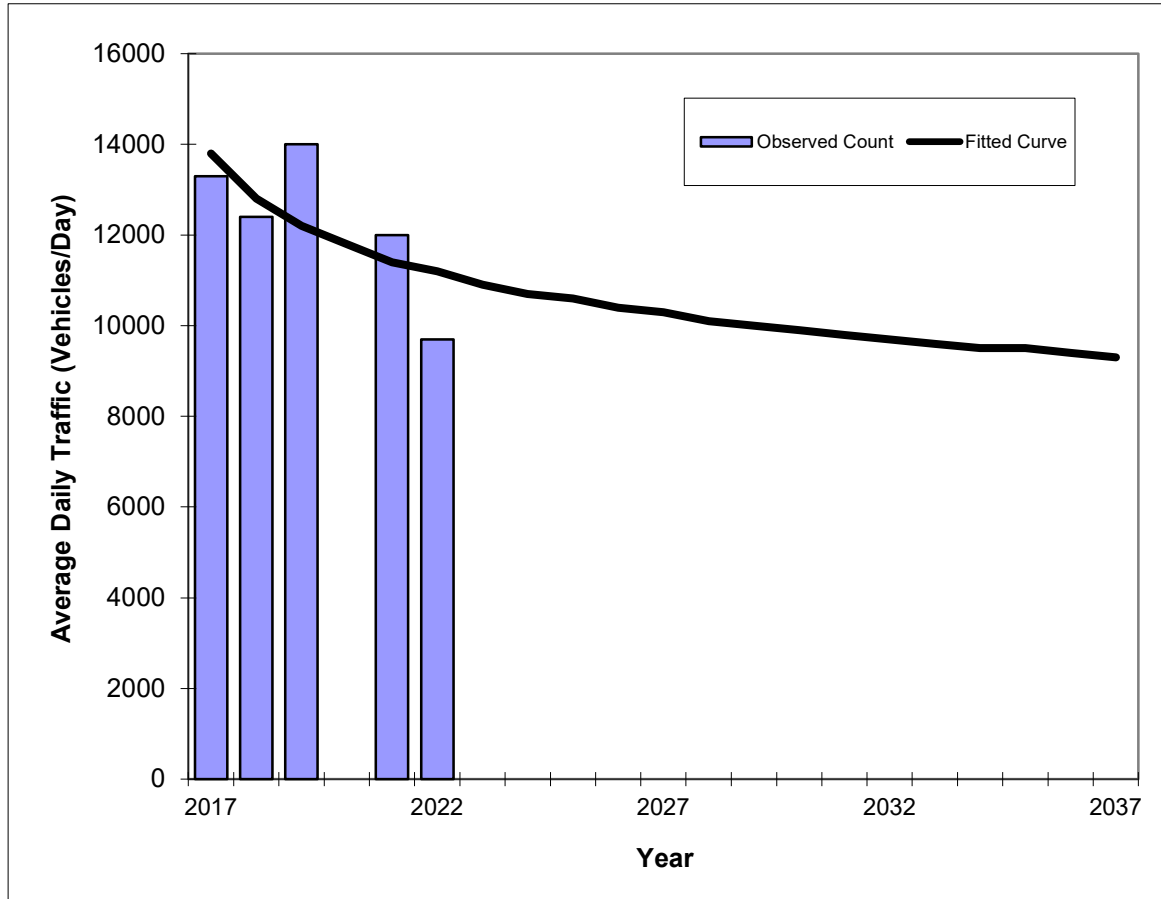

Year	Traffic (ADT/AADT)	
	Count*	Trend**
2017	13300	13800
2018	12400	12800
2019	14000	12200
2020	N/A	N/A
2021	12000	11400
2022	9700	11200
2023 Opening Year Trend		
2023	N/A	10900
2024 Mid-Year Trend		
2024	N/A	10700
2026 Design Year Trend		
2026	N/A	10400
TRANPLAN Forecasts/Trends		

Trend R-squared:	42.70%
Compounded Annual Historic Growth Rate:	-4.09%
Compounded Growth Rate (2022 to Design Year):	-1.84%
Printed:	26-Aug-23
Decaying Exponential Growth Option	

*Axle-Adjusted

Traffic Trends - V03.a
SR 907/ALTON RD -- 200' S OF VENETIAN CSWY

FIN#	0
Location	2

County:	MIAMI-DADE
Station #:	2542
Highway:	SR 907/ALTON RD

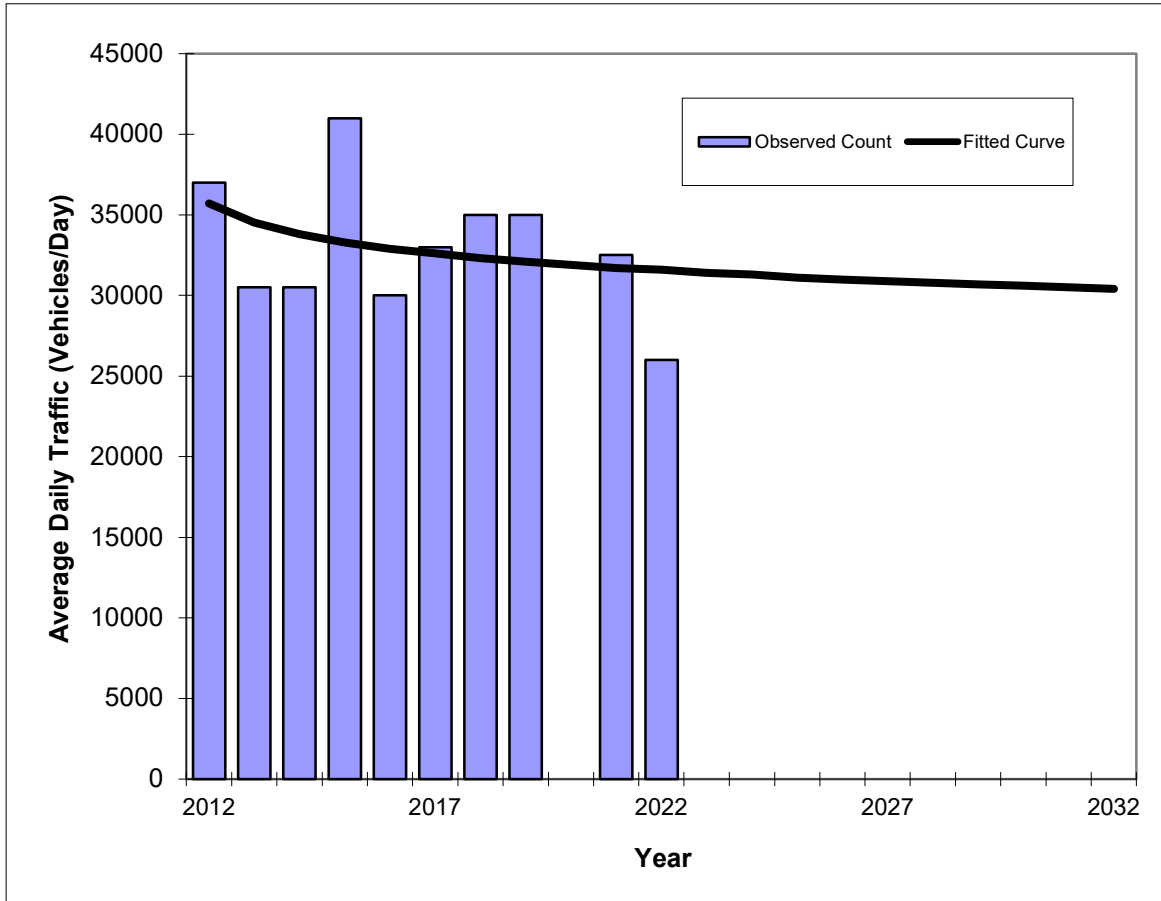

Year	Traffic (ADT/AADT)	
	Count*	Trend**
2012	37000	35700
2013	30500	34500
2014	30500	33800
2015	41000	33300
2016	30000	32900
2017	33000	32600
2018	35000	32300
2019	35000	32100
2020	N/A	N/A
2021	32500	31700
2022	26000	31600
2023 Opening Year Trend		
2023	N/A	31400
2024 Mid-Year Trend		
2024	N/A	31300
2026 Design Year Trend		
2026	N/A	31000
TRANPLAN Forecasts/Trends		

Trend R-squared:	14.51%
Compounded Annual Historic Growth Rate:	-1.21%
Compounded Growth Rate (2022 to Design Year):	-0.48%
Printed:	26-Aug-23
Exponential Growth Option	

*Axle-Adjusted

Traffic Trends - V03.a

SR 907/ALTON RD -- 200' S OF VENETIAN CSWY

FIN#	0
Location	2

County:	MIAMI-DADE
Station #:	2542
Highway:	SR 907/ALTON RD

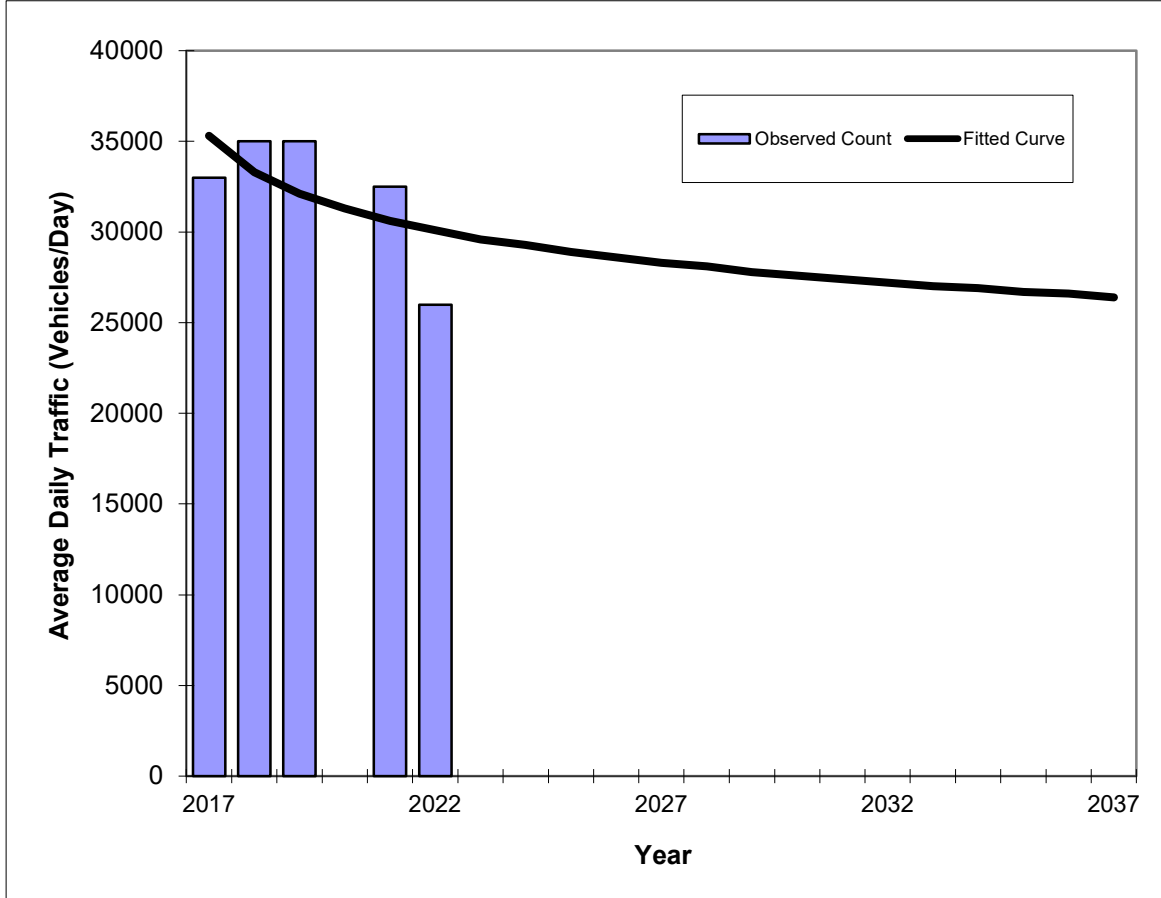

Year	Traffic (ADT/AADT)	
	Count*	Trend**
2017	33000	35300
2018	35000	33300
2019	35000	32100
2020	N/A	N/A
2021	32500	30600
2022	26000	30100
2023 Opening Year Trend		
2023	N/A	29600
2024 Mid-Year Trend		
2024	N/A	29300
2026 Design Year Trend		
2026	N/A	28600
TRANPLAN Forecasts/Trends		

Trend R-squared:	54.27%
Compounded Annual Historic Growth Rate:	-3.14%
Compounded Growth Rate (2022 to Design Year):	-1.27%
Printed:	26-Aug-23
Exponential Growth Option	

*Axle-Adjusted

Traffic Trends - V03.a

SR 907/ALTON RD -- 200' S OF VENETIAN CSWY

FIN#	0
Location	2

County:	MIAMI-DADE
Station #:	2542
Highway:	SR 907/ALTON RD

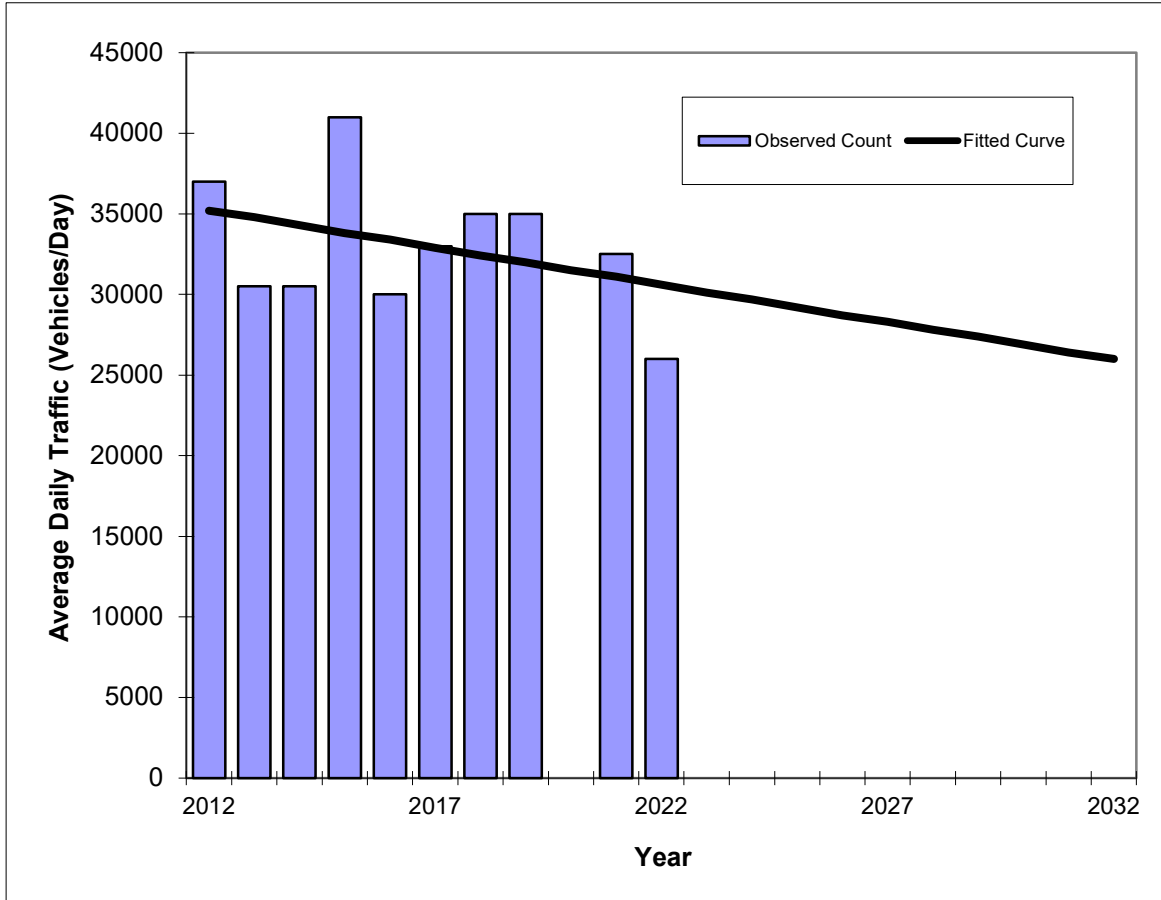

Year	Traffic (ADT/AADT)	
	Count*	Trend**
2012	37000	35200
2013	30500	34800
2014	30500	34300
2015	41000	33800
2016	30000	33400
2017	33000	32900
2018	35000	32400
2019	35000	32000
2020	N/A	N/A
2021	32500	31100
2022	26000	30600
2023 Opening Year Trend		
2023	N/A	30100
2024 Mid-Year Trend		
2024	N/A	29700
2026 Design Year Trend		
2026	N/A	28700
TRANPLAN Forecasts/Trends		

** Annual Trend Increase:	-463
Trend R-squared:	13.52%
Trend Annual Historic Growth Rate:	-1.31%
Trend Growth Rate (2022 to Design Year):	-1.55%
Printed:	26-Aug-23

Straight Line Growth Option

*Axle-Adjusted

Traffic Trends - V03.a
SR 907/ALTON RD -- 200' S OF VENETIAN CSWY

FIN#	0
Location	2

County:	MIAMI-DADE
Station #:	2542
Highway:	SR 907/ALTON RD

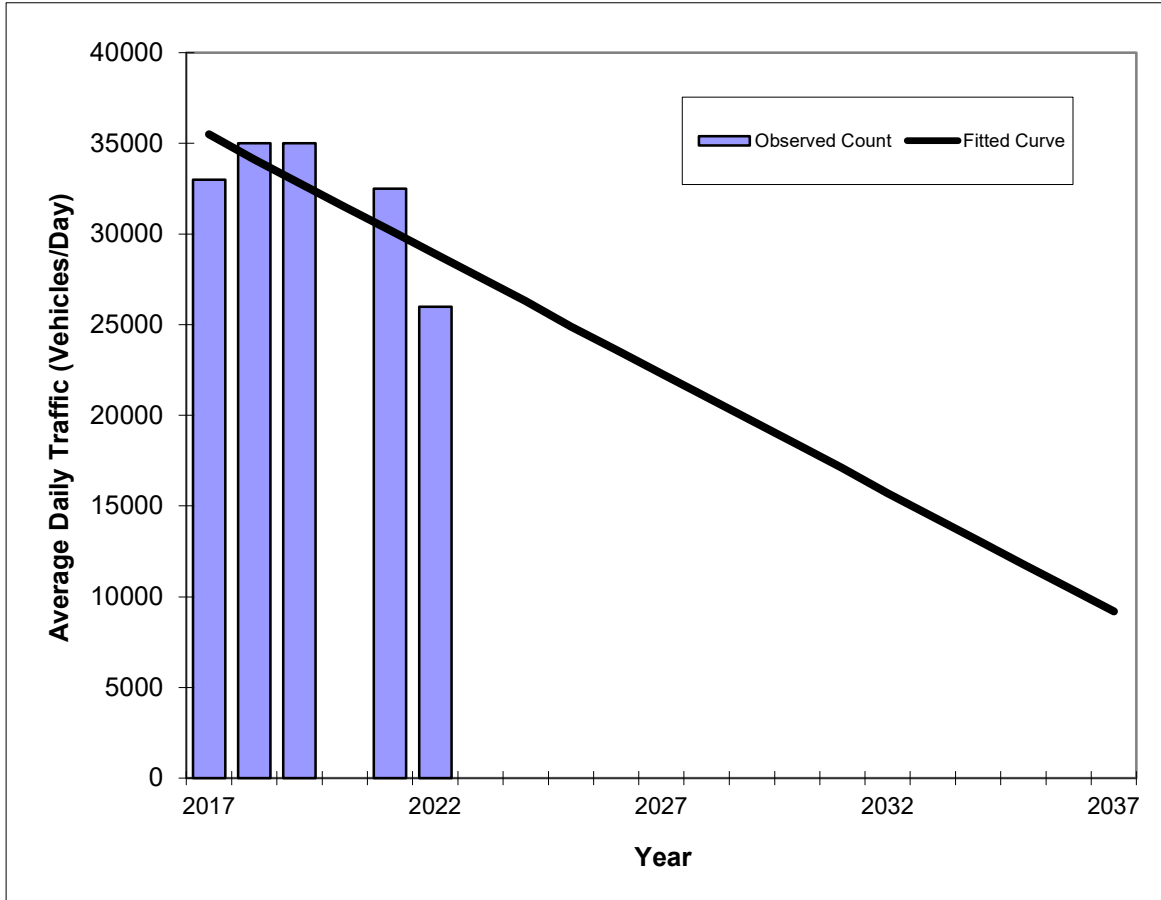

Year	Traffic (ADT/AADT)	
	Count*	Trend**
2017	33000	35500
2018	35000	34100
2019	35000	32800
2020	N/A	N/A
2021	32500	30200
2022	26000	28900
2023 Opening Year Trend		
2023	N/A	27600
2024 Mid-Year Trend		
2024	N/A	26300
2026 Design Year Trend		
2026	N/A	23600
TRANPLAN Forecasts/Trends		

** Annual Trend Increase:	-1,314
Trend R-squared:	54.19%
Trend Annual Historic Growth Rate:	-3.72%
Trend Growth Rate (2022 to Design Year):	-4.58%
Printed:	26-Aug-23
Straight Line Growth Option	

*Axle-Adjusted

Traffic Trends - V03.a

VENETIAN CSWY -- 200' EAST OF WEST AVENUE

FIN#	0
Location	3

County:	MIAMI-DADE
Station #:	8350
Highway:	VENETIAN CSWY

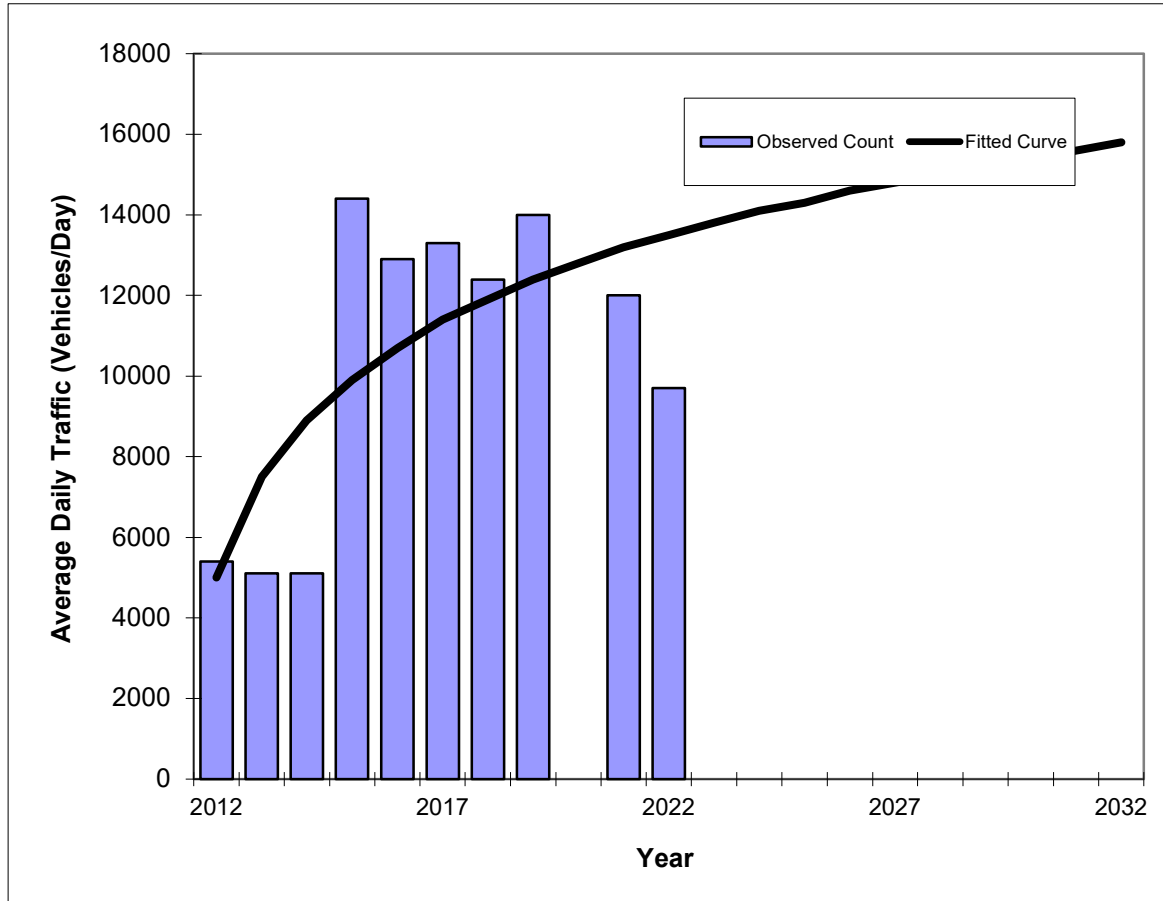

Year	Traffic (ADT/AADT)	
	Count*	Trend**
2012	5400	5000
2013	5100	7500
2014	5100	8900
2015	14400	9900
2016	12900	10700
2017	13300	11400
2018	12400	11900
2019	14000	12400
2020	N/A	N/A
2021	12000	13200
2022	9700	13500
2023 Opening Year Trend		
2023	N/A	13800
2024 Mid-Year Trend		
2024	N/A	14100
2026 Design Year Trend		
2026	N/A	14600
TRANPLAN Forecasts/Trends		

Trend R-squared:	48.77%
Compounded Annual Historic Growth Rate:	10.44%
Compounded Growth Rate (2022 to Design Year):	1.98%
Printed:	26-Aug-23
Decaying Exponential Growth Option	

*Axle-Adjusted

Traffic Trends - V03.a

VENETIAN CSWY -- 200' EAST OF WEST AVENUE

FIN#	0
Location	3

County:	MIAMI-DADE
Station #:	8350
Highway:	VENETIAN CSWY

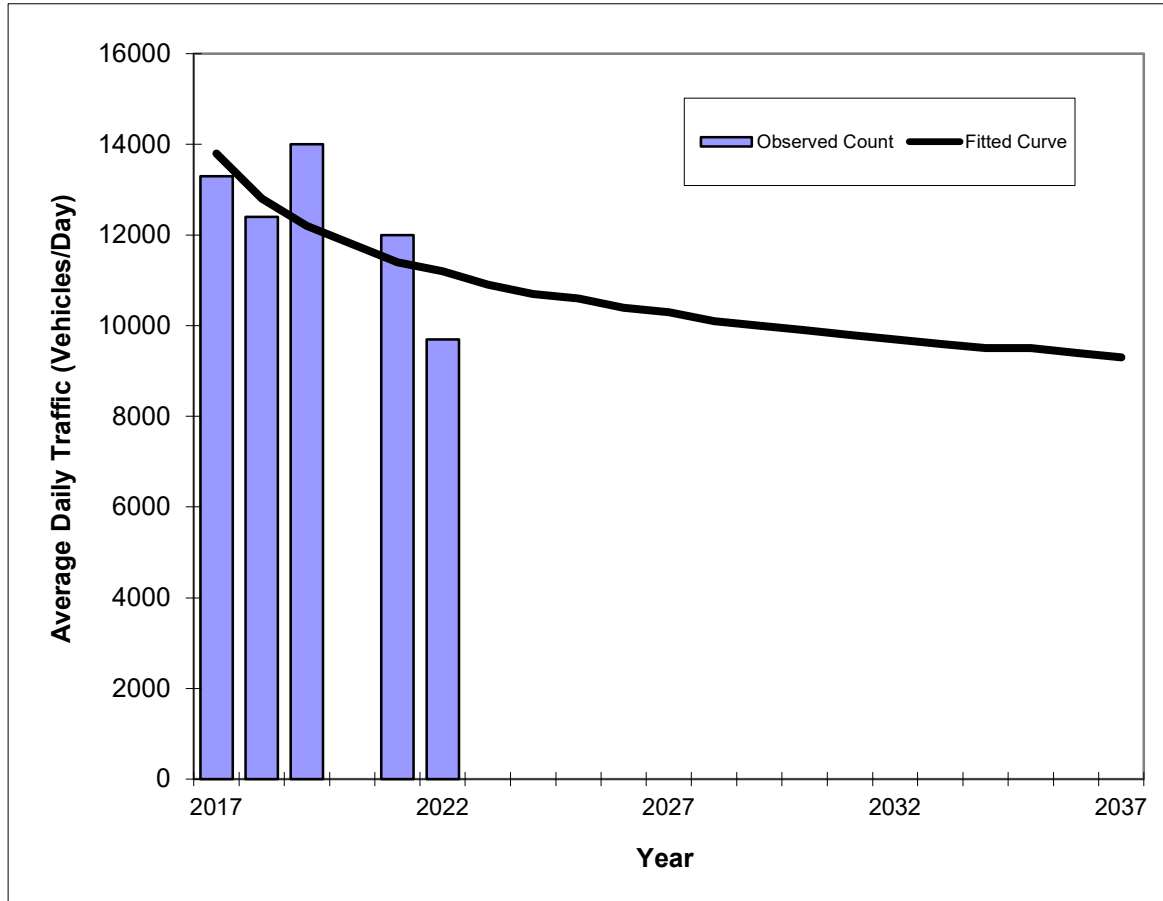

Year	Traffic (ADT/AADT)	
	Count*	Trend**
2017	13300	13800
2018	12400	12800
2019	14000	12200
2020	N/A	N/A
2021	12000	11400
2022	9700	11200
2023 Opening Year Trend		
2023	N/A	10900
2024 Mid-Year Trend		
2024	N/A	10700
2026 Design Year Trend		
2026	N/A	10400
TRANPLAN Forecasts/Trends		

Trend R-squared:	42.70%
Compounded Annual Historic Growth Rate:	-4.09%
Compounded Growth Rate (2022 to Design Year):	-1.84%
Printed:	26-Aug-23
Decaying Exponential Growth Option	

*Axle-Adjusted

Traffic Trends - V03.a

VENETIAN CSWY -- 200' EAST OF WEST AVENUE

FIN#	0
Location	3

County:	MIAMI-DADE
Station #:	8350
Highway:	VENETIAN CSWY

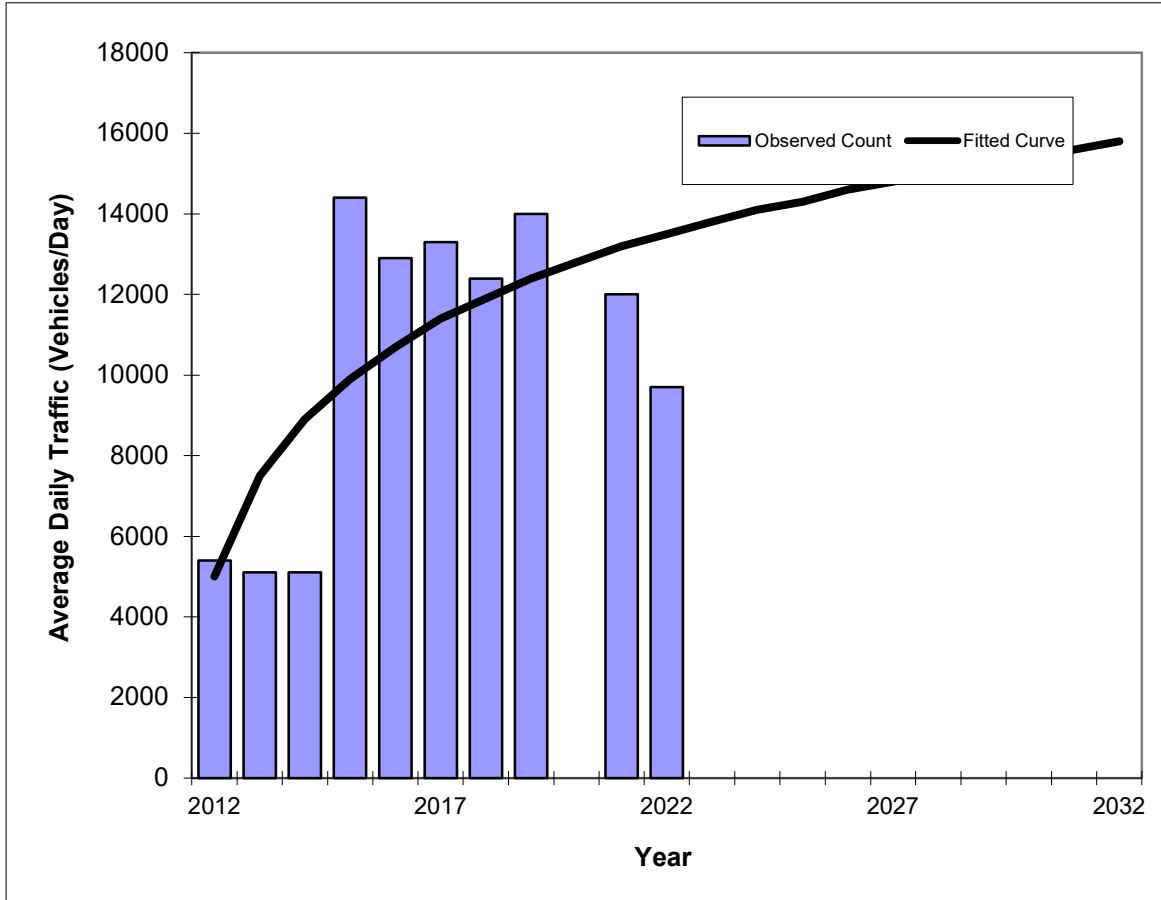

Year	Traffic (ADT/AADT)	
	Count*	Trend**
2012	5400	5000
2013	5100	7500
2014	5100	8900
2015	14400	9900
2016	12900	10700
2017	13300	11400
2018	12400	11900
2019	14000	12400
2020	N/A	N/A
2021	12000	13200
2022	9700	13500
2023 Opening Year Trend		
2023	N/A	13800
2024 Mid-Year Trend		
2024	N/A	14100
2026 Design Year Trend		
2026	N/A	14600
TRANPLAN Forecasts/Trends		

Trend R-squared:	38.17%
Compounded Annual Historic Growth Rate:	10.44%
Compounded Growth Rate (2022 to Design Year):	1.98%
Printed:	26-Aug-23
Exponential Growth Option	

*Axle-Adjusted

Traffic Trends - V03.a

VENETIAN CSWY -- 200' EAST OF WEST AVENUE

FIN#	0
Location	3

County:	MIAMI-DADE
Station #:	8350
Highway:	VENETIAN CSWY

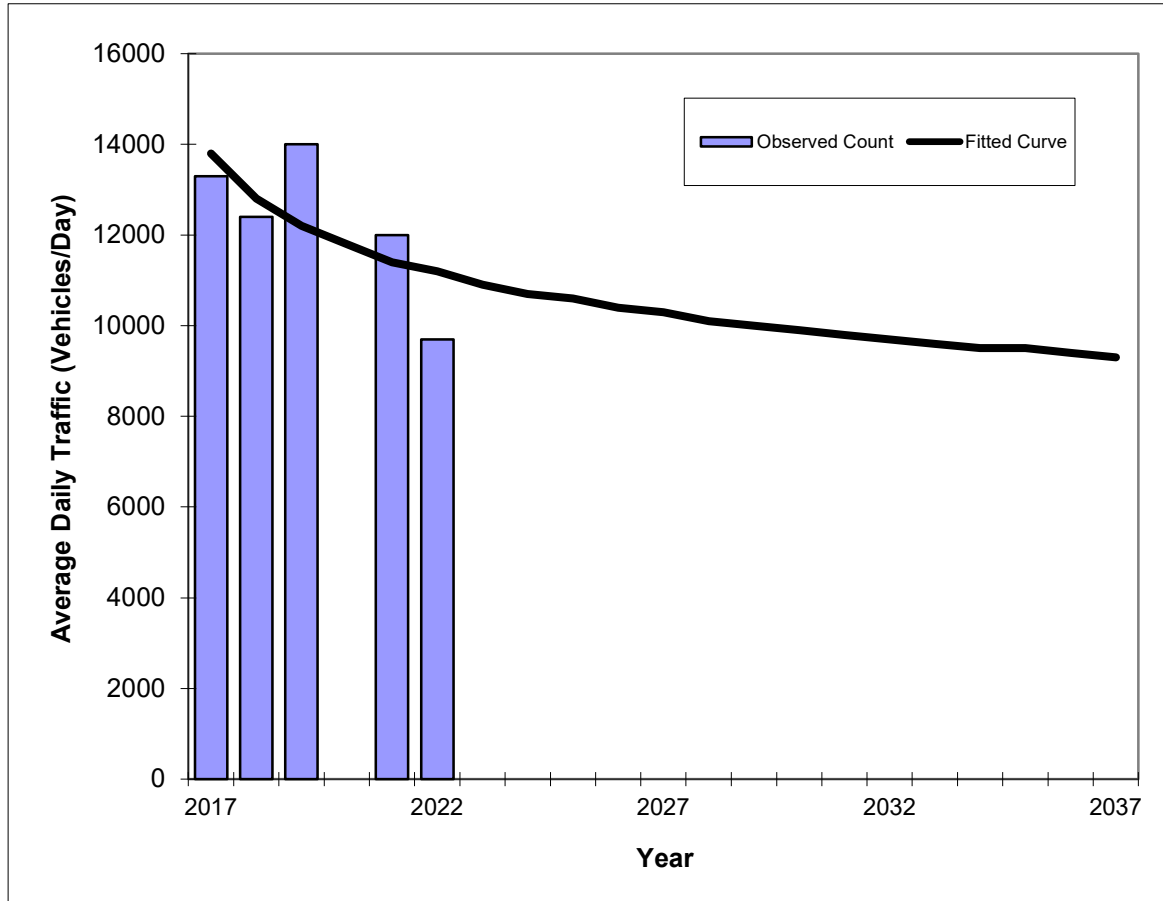

Year	Traffic (ADT/AADT)	
	Count*	Trend**
2017	13300	13800
2018	12400	12800
2019	14000	12200
2020	N/A	N/A
2021	12000	11400
2022	9700	11200
2023 Opening Year Trend		
2023	N/A	10900
2024 Mid-Year Trend		
2024	N/A	10700
2026 Design Year Trend		
2026	N/A	10400
TRANPLAN Forecasts/Trends		

Trend R-squared:	60.24%
Compounded Annual Historic Growth Rate:	-4.09%
Compounded Growth Rate (2022 to Design Year):	-1.84%
Printed:	26-Aug-23
Exponential Growth Option	

*Axle-Adjusted

Traffic Trends - V03.a

VENETIAN CSWY -- 200' EAST OF WEST AVENUE

FIN#	0
Location	3

County:	MIAMI-DADE
Station #:	8350
Highway:	VENETIAN CSWY

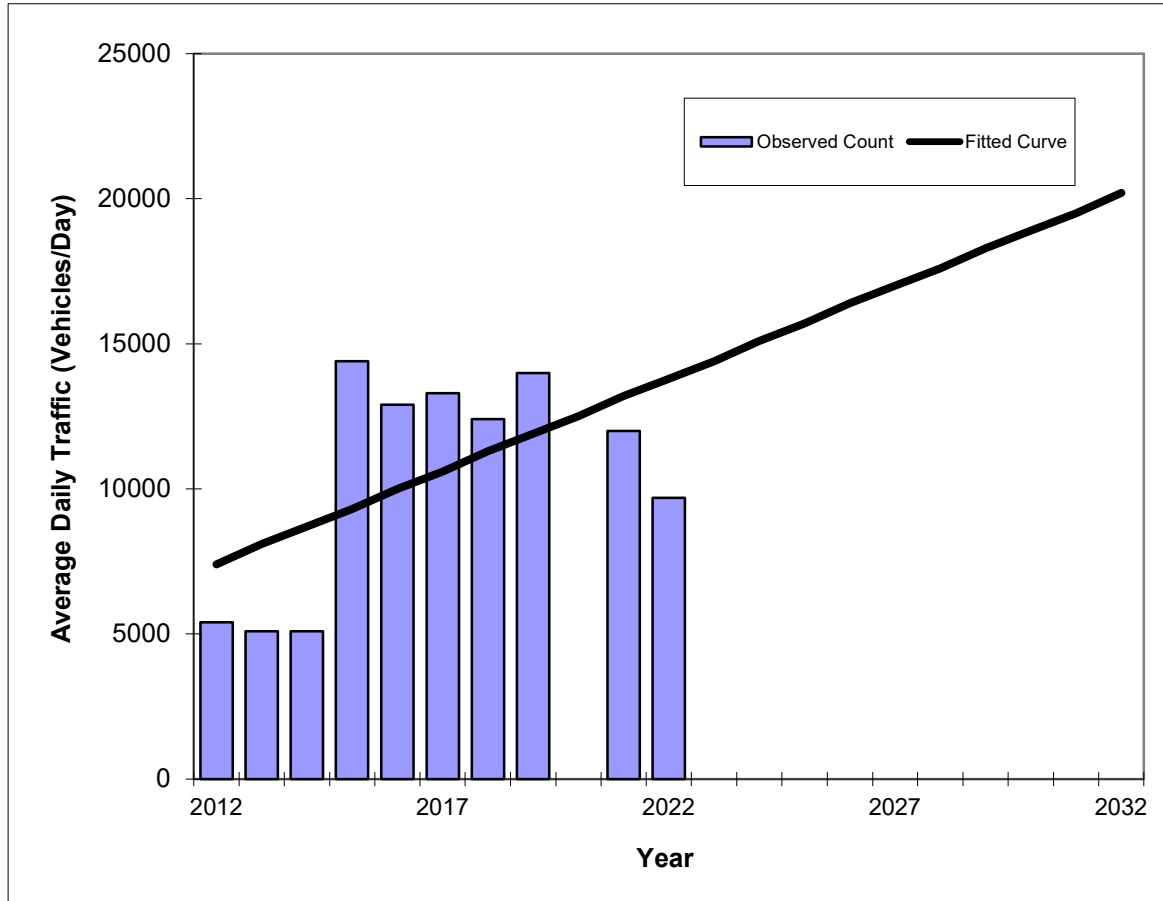

Year	Traffic (ADT/AADT)	
	Count*	Trend**
2012	5400	7400
2013	5100	8100
2014	5100	8700
2015	14400	9300
2016	12900	10000
2017	13300	10600
2018	12400	11300
2019	14000	11900
2020	N/A	N/A
2021	12000	13200
2022	9700	13800
2023 Opening Year Trend		
2023	N/A	14400
2024 Mid-Year Trend		
2024	N/A	15100
2026 Design Year Trend		
2026	N/A	16400
TRANPLAN Forecasts/Trends		

** Annual Trend Increase:	637
Trend R-squared:	30.83%
Trend Annual Historic Growth Rate:	8.65%
Trend Growth Rate (2022 to Design Year):	4.71%
Printed:	26-Aug-23

Straight Line Growth Option

*Axle-Adjusted

Traffic Trends - V03.a

VENETIAN CSWY -- 200' EAST OF WEST AVENUE

FIN#	0
Location	3

County:	MIAMI-DADE
Station #:	8350
Highway:	VENETIAN CSWY

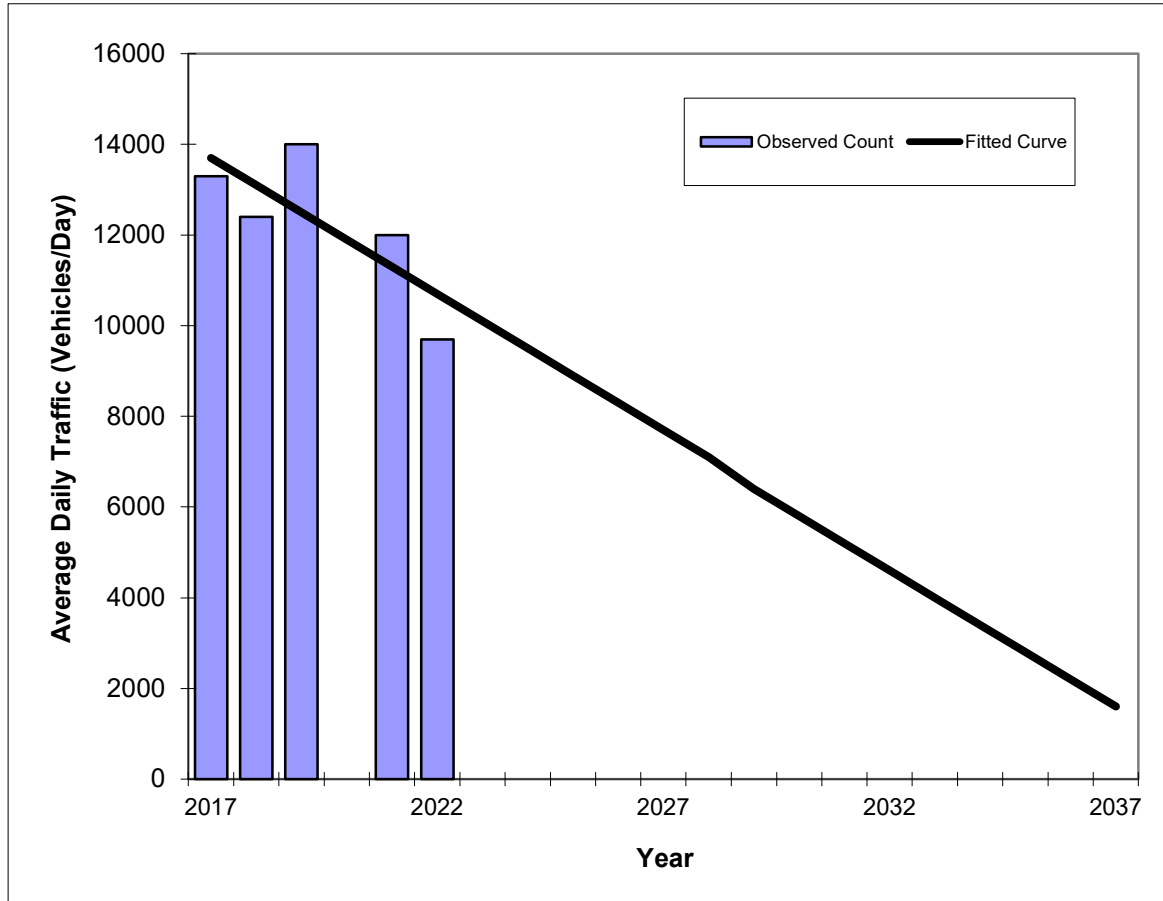

Year	Traffic (ADT/AADT)	
	Count*	Trend**
2017	13300	13700
2018	12400	13100
2019	14000	12500
2020	N/A	N/A
2021	12000	11300
2022	9700	10700
2023 Opening Year Trend		
2023	N/A	10100
2024 Mid-Year Trend		
2024	N/A	9500
2026 Design Year Trend		
2026	N/A	8300
TRANPLAN Forecasts/Trends		

** Annual Trend Increase:	-608
Trend R-squared:	59.18%
Trend Annual Historic Growth Rate:	-4.38%
Trend Growth Rate (2022 to Design Year):	-5.61%
Printed:	26-Aug-23
Straight Line Growth Option	

*Axle-Adjusted

Growth Rate Trend Analysis Calculations - 5 Years									
Description	FDOT Historical AADT Data								
	0012			2542			8350		
Option	Linear	Exponential	Decaying Exponential	Linear	Exponential	Decaying Exponential	Linear	Exponential	Decaying Exponential
Trend Growth Rate 5 years	-0.63	-0.68	-0.68	-3.72	-3.14	-4.09	-4.38	-4.09	-4.09
Trend R-squared 5 years	4.96	4.96	5.13	54.19	54.27	42.70	59.18	60.24	42.70
Average Growth Rate (5-year) Linear all stations	-2.91								
Average Growth Rate (5-year) Exponential all stations	-2.64								
Average Growth Rate (5-year) Decaying Exponential all stations	-2.95								
Highest R-Square	60.24								
Growth Rate (5-year) with the highest R- Square	-2.95								

Growth Rate Trend Analysis Calculations - 10 Years									
Description	FDOT Historical AADT Data								
	0012			2542			8350		
Option	Linear	Exponential	Decaying Exponential	Linear	Exponential	Decaying Exponential	Linear	Exponential	Decaying Exponential
Trend Growth Rate 10 years	-0.38	-0.44	-0.44	-1.31	-1.21	-1.21	8.65	10.44	10.44
Trend R-squared 10 years	9.18	9.78	11.33	13.52	14.51	9.63	30.83	38.17	48.77
Average Growth Rate (10-year) Linear all stations	2.32								
Average Growth Rate (10-year) Exponential all stations	2.93								
Average Growth Rate (10-year) Decaying Exponential all stations	2.93								
Highest R-Square	48.77								
Growth Rate (10-year) with highest R- Square	2.93								

Notes:

What Is R-squared?

R-squared is a statistical measure of how close the data are to the fitted regression line. It is also known as the coefficient of determination, or the coefficient of multiple determination for multiple regression.

The definition of R-squared is fairly straight-forward; it is the percentage of the response variable variation that is explained by a linear model. Or:

R-squared = Explained variation / Total variation

R-squared is always between 0 and 100%:

0% indicates that the model explains none of the variability of the response data around its mean.

100% indicates that the model explains all the variability of the response data around its mean.

In general, the higher the R-squared, the better the model fits your data. However, there are important conditions for this guideline that I'll talk about both in this post and my next post.

Miami-Dade 2015 Base Year Direction Trip Distribution Summary												
TAZ of Origin		Trips / Percent	Cardinal Directions								Total Trips	
County TAZ	Regional TAZ		NNE	ENE	ESE	SSE	SSW	WSW	WNW	NNW		
625	3525	Trips	610	160	-	557	431	1,317	679	1,035	4,961	
625	3525	Percent	12.7	3.3	-	11.6	9.0	27.5	14.2	21.6		
626	3526	Trips	122	-	-	-	2,090	2,277	1,198	2,942	9,399	
626	3526	Percent	1.4	-	-	-	24.2	26.4	13.9	34.1		
627	3527	Trips	279	-	-	-	2,051	2,578	845	1,965	8,061	
627	3527	Percent	3.6	-	-	-	26.6	33.4	11.0	25.5		
628	3528	Trips	298	-	49	79	984	902	332	679	3,579	
628	3528	Percent	9.0	-	1.5	2.4	29.6	27.2	10.0	20.5		
629	3529	Trips	1,374	549	344	1,656	1,708	3,707	1,668	2,101	14,261	
629	3529	Percent	10.5	4.2	2.6	12.6	13.0	28.3	12.7	16.0		
630	3530	Trips	952	-	210	347	1,696	2,375	794	1,114	8,135	
630	3530	Percent	12.7	-	2.8	4.6	22.7	31.7	10.6	14.9		
631	3531	Trips	255	-	-	-	1,215	1,471	440	1,030	4,651	
631	3531	Percent	5.8	-	-	-	27.6	33.4	10.0	23.4		
632	3532	Trips	309	-	-	-	1,242	1,751	750	635	4,880	
632	3532	Percent	6.6	-	-	-	26.5	37.4	16.0	13.5		
633	3533	Trips	310	-	-	-	1,181	1,428	750	730	4,590	
633	3533	Percent	7.0	-	-	-	26.9	32.5	17.1	16.6		
634	3534	Trips	1,502	112	240	837	1,718	1,928	976	1,727	9,998	
634	3534	Percent	16.6	1.2	2.7	9.3	19.0	21.3	10.8	19.1		
635	3535	Trips	779	-	-	-	2,021	1,994	952	1,411	8,010	
635	3535	Percent	10.9	-	-	-	28.2	27.9	13.3	19.7		
636	3536	Trips	1,041	-	-	686	1,152	2,072	911	1,071	7,384	
636	3536	Percent	15.0	-	-	9.9	16.6	29.9	13.1	15.4		
637	3537	Trips	323	31	87	217	126	601	303	290	1,987	
637	3537	Percent	16.4	1.6	4.4	11.0	6.4	30.4	15.3	14.7		
638	3538	Trips	152	35	87	86	114	218	162	126	999	
638	3538	Percent	15.5	3.6	8.9	8.7	11.6	22.3	16.5	12.9		
639	3539	Trips	825	281	277	1,089	131	1,364	796	599	5,721	
639	3539	Percent	15.4	5.2	5.2	20.3	2.4	25.4	14.9	11.2		
640	3540	Trips	344	247	868	104	43	685	405	274	3,053	
640	3540	Percent	11.6	8.3	29.2	3.5	1.5	23.1	13.6	9.2		
641	3541	Trips	1,051	1,714	291	723	309	1,572	1,188	916	8,356	
641	3541	Percent	13.5	22.1	3.7	9.3	4.0	20.3	15.3	11.8		
642	3542	Trips	1,849	1,404	115	1,263	457	2,697	1,962	1,518	12,299	
642	3542	Percent	16.4	12.5	1.0	11.2	4.1	23.9	17.4	13.5		
643	3543	Trips	1,747	551	-	965	479	2,595	1,554	1,715	10,383	
643	3543	Percent	18.2	5.7	-	10.1	5.0	27.0	16.2	17.9		
644	3544	Trips	2,022	-	-	-	2,250	4,141	2,585	2,646	15,224	
644	3544	Percent	14.8	-	-	-	16.5	30.4	19.0	19.4		
645	3545	Trips	1,268	-	-	-	907	1,498	1,720	1,351	7,018	
645	3545	Percent	18.8	-	-	-	13.5	22.2	25.5	20.0		
646	3546	Trips	986	-	156	520	250	1,081	1,094	1,181	5,470	
646	3546	Percent	18.7	-	3.0	9.9	4.7	20.5	20.8	22.4		
647	3547	Trips	350	103	114	165	66	354	359	408	1,979	
647	3547	Percent	18.2	5.4	5.9	8.6	3.5	18.5	18.7	21.2		
648	3548	Trips	1,027	434	254	401	48	903	1,001	514	4,747	
648	3548	Percent	22.4	9.5	5.5	8.8	1.0	19.7	21.9	11.2		
649	3549	Trips	754	192	184	230	41	612	743	427	3,320	
649	3549	Percent	23.7	6.0	5.8	7.2	1.3	19.2	23.3	13.4		
650	3550	Trips	45	80	104	0	14	155	304	133	850	
650	3550	Percent	5.4	9.6	12.4	0.0	1.6	18.5	36.5	16.0		

Miami-Dade 2045 Cost Feasible Plan Direction Trip Distribution Summary												
TAZ of Origin		Trips / Percent	Cardinal Directions								Total Trips	
County TAZ	Regional TAZ		NNE	ENE	ESE	SSE	SSW	WSW	WNW	NNW		
625	3525	Trips	515	114	-	541	802	1,791	829	1,096	5,972	
625	3525	Percent	9.1	2.0	-	9.5	14.1	31.5	14.6	19.3		
626	3526	Trips	66	-	-	-	2,417	3,260	1,417	2,993	11,237	
626	3526	Percent	0.7	-	-	-	23.8	32.1	14.0	29.5		
627	3527	Trips	174	-	-	-	2,276	3,212	1,138	1,885	9,055	
627	3527	Percent	2.0	-	-	-	26.2	37.0	13.1	21.7		
628	3528	Trips	238	-	23	101	1,053	1,266	390	660	4,028	
628	3528	Percent	6.4	-	0.6	2.7	28.2	33.9	10.5	17.7		
629	3529	Trips	1,686	621	373	1,692	1,801	6,032	2,362	2,490	18,425	
629	3529	Percent	9.9	3.6	2.2	9.9	10.6	35.4	13.9	14.6		
630	3530	Trips	888	-	326	303	1,717	3,876	1,515	1,553	11,277	
630	3530	Percent	8.7	-	3.2	3.0	16.9	38.1	14.9	15.3		
631	3531	Trips	296	-	-	-	1,351	2,360	838	1,324	6,591	
631	3531	Percent	4.8	-	-	-	21.9	38.3	13.6	21.5		
632	3532	Trips	343	-	-	-	1,500	2,647	1,390	1,098	7,499	
632	3532	Percent	4.9	-	-	-	21.5	37.9	19.9	15.7		
633	3533	Trips	368	-	-	-	1,052	1,986	859	841	5,391	
633	3533	Percent	7.2	-	-	-	20.6	38.9	16.8	16.5		
634	3534	Trips	1,404	80	149	773	1,637	2,733	1,332	1,712	10,593	
634	3534	Percent	14.3	0.8	1.5	7.9	16.7	27.8	13.6	17.4		
635	3535	Trips	566	-	-	-	1,311	2,266	1,228	1,254	7,246	
635	3535	Percent	8.5	-	-	-	19.8	34.2	18.5	18.9		
636	3536	Trips	1,066	-	-	607	978	3,045	1,398	1,193	8,805	
636	3536	Percent	12.9	-	-	7.3	11.8	36.8	16.9	14.4		
637	3537	Trips	468	44	144	315	198	868	501	309	2,865	
637	3537	Percent	16.5	1.6	5.1	11.1	6.9	30.5	17.6	10.9		
638	3538	Trips	127	33	78	94	79	401	285	185	1,342	
638	3538	Percent	9.9	2.6	6.1	7.3	6.2	31.3	22.2	14.5		
639	3539	Trips	944	303	253	1,068	176	2,395	1,085	905	7,569	
639	3539	Percent	13.2	4.3	3.6	15.0	2.5	33.6	15.2	12.7		
640	3540	Trips	119	74	216	10	30	177	136	147	1,166	
640	3540	Percent	13.1	8.2	23.7	1.1	3.4	19.4	14.9	16.2		
641	3541	Trips	1,145	1,056	206	569	242	2,378	1,724	1,142	9,066	
641	3541	Percent	13.5	12.5	2.4	6.7	2.9	28.1	20.4	13.5		
642	3542	Trips	1,701	1,196	113	964	433	3,470	2,140	1,631	12,324	
642	3542	Percent	14.6	10.3	1.0	8.3	3.7	29.8	18.4	14.0		
643	3543	Trips	1,884	580	-	1,133	631	3,768	2,190	2,157	13,183	
643	3543	Percent	15.3	4.7	-	9.2	5.1	30.5	17.7	17.5		
644	3544	Trips	1,948	-	-	-	2,227	5,534	3,264	3,082	17,780	
644	3544	Percent	12.1	-	-	-	13.9	34.5	20.3	19.2		
645	3545	Trips	1,314	-	-	-	844	1,661	2,170	1,703	8,075	
645	3545	Percent	17.1	-	-	-	11.0	21.6	28.2	22.1		
646	3546	Trips	1,025	-	125	496	263	1,741	1,656	1,299	6,976	
646	3546	Percent	15.5	-	1.9	7.5	4.0	26.4	25.1	19.7		
647	3547	Trips	296	122	96	109	79	582	661	405	2,490	
647	3547	Percent	12.6	5.2	4.1	4.6	3.4	24.8	28.1	17.3		
648	3548	Trips	943	278	128	313	73	1,525	1,351	576	5,397	
648	3548	Percent	18.2	5.4	2.5	6.0	1.4	29.4	26.0	11.1		
649	3549	Trips	643	120	121	216	43	873	952	508	3,661	
649	3549	Percent	18.5	3.4	3.5	6.2	1.3	25.1	27.4	14.6		
650	3550	Trips	60	71	65	8	14	279	312	136	969	
650	3550	Percent	6.4	7.5	6.9	0.9	1.5	29.5	33.0	14.4		

APPENDIX D

Future Turning Movement Volumes and Committed Developments Information

FUTURE TURNING MOVEMENT VOLUME ANALYSIS

**Alton Road and Michigan Avenue
AM Peak Hour**

Description	Alton Road Northbound			Alton Road Southbound			Michigan Avenue Eastbound			Michigan Avenue Westbound		
	Left	Through	Right	Left	Through	Right	Left	Through	Right	Left	Through	Right
Existing Traffic (8/9/2023)	7	616	30	392	1,247	18	13	8	6	17	3	218
Season Adjustment Factor	1.05	1.05	1.05	1.05	1.05	1.05	1.05	1.05	1.05	1.05	1.05	1.05
2023 Peak Season Traffic	7	647	32	412	1,309	19	14	8	6	18	3	229
Annual Growth Rate	2.9%	2.9%	2.9%	2.9%	2.9%	2.9%	2.9%	2.9%	2.9%	2.9%	2.9%	2.9%
Committed Developments 1920 Alton Road												
2026 Background Traffic	8	705	34	449	1,428	21	15	9	7	19	3	250
1901 Alton	1	2	1	5				1				
2026 Total Traffic	9	707	35	454	1,428	21	15	10	7	19	3	250

FUTURE TURNING MOVEMENT VOLUME ANALYSIS

**Alton Road and Michigan Avenue
PM Peak Hour**

Description	Alton Road Northbound			Alton Road Southbound			Michigan Avenue Eastbound			Michigan Avenue Westbound		
	Left	Through	Right	Left	Through	Right	Left	Through	Right	Left	Through	Right
Existing Traffic (8/9/2023)	5	1,121	23	274	880	5	13	11	2	23	14	597
Season Adjustment Factor	1.05	1.05	1.05	1.05	1.05	1.05	1.05	1.05	1.05	1.05	1.05	1.05
2023 Peak Season Traffic	5	1,177	24	288	924	5	14	12	2	24	15	627
Annual Growth Rate	2.9%	2.9%	2.9%	2.9%	2.9%	2.9%	2.9%	2.9%	2.9%	2.9%	2.9%	2.9%
Committed Developments 1920 Alton Road												
2026 Background Traffic	6	1,284	26	314	1,008	6	15	13	2	26	16	684
1901 Alton	7	20	6	20				7				
2026 Total Traffic	13	1,304	32	334	1,008	6	15	20	2	26	16	684

FUTURE TURNING MOVEMENT VOLUME ANALYSIS

**Alton Road and 20th Street
AM Peak Hour**

Description	Alton Road Northbound			Alton Road Southbound			20th Street Eastbound			20th Street Westbound		
	Left	Through	Right	Left	Through	Right	Left	Through	Right	Left	Through	Right
Existing Traffic (8/9/2023)	95	513	10	25	1,050	233	126	3	13	2	3	5
Season Adjustment Factor	1.05	1.05	1.05	1.05	1.05	1.05	1.05	1.05	1.05	1.05	1.05	1.05
2023 Peak Season Traffic	100	539	11	26	1,103	245	132	3	14	2	3	5
Annual Growth Rate	2.9%	2.9%	2.9%	2.9%	2.9%	2.9%	2.9%	2.9%	2.9%	2.9%	2.9%	2.9%
Committed Developments 1920 Alton Road	9					4						
2026 Background Traffic	118	587	11	29	1,202	271	144	3	15	2	3	6
1901 Alton	1	3					1					
2026 Total Traffic	119	590	11	29	1,202	271	145	3	15	2	3	6

FUTURE TURNING MOVEMENT VOLUME ANALYSIS

**Alton Road and 20th Street
PM Peak Hour**

Description	Alton Road Northbound			Alton Road Southbound			20th Street Eastbound			20th Street Westbound		
	Left	Through	Right	Left	Through	Right	Left	Through	Right	Left	Through	Right
Existing Traffic (8/9/2023)	79	979	4	5	737	178	165	7	21			11
Season Adjustment Factor	1.05	1.05	1.05	1.05	1.05	1.05	1.05	1.05	1.05	1.05	1.05	1.05
2023 Peak Season Traffic	83	1,028	4	5	774	187	173	7	22	0	0	12
Annual Growth Rate	2.9%	2.9%	2.9%	2.9%	2.9%	2.9%	2.9%	2.9%	2.9%	2.9%	2.9%	2.9%
Committed Developments 1920 Alton Road	2					1	5		10			
2026 Background Traffic	92	1,121	5	6	844	205	194	8	34	0	0	13
1901 Alton	7	27				6						
2026 Total Traffic	99	1,148	5	6	844	211	194	8	34	0	0	13

FUTURE TURNING MOVEMENT VOLUME ANALYSIS

**Alton Road and 19th Street
AM Peak Hour**

Description	Alton Road Northbound			Alton Road Southbound			19th Street Eastbound			19th Street Westbound		
	Left	Through	Right	Left	Through	Right	Left	Through	Right	Left	Through	Right
Existing Traffic (8/9/2023)	0	600	20	0	1,027		0	0		0	0	33
Season Adjustment Factor	1.05	1.05	1.05	1.05	1.05	1.05	1.05	1.05	1.05	1.05	1.05	1.05
2023 Peak Season Traffic	0	630	21	0	1,078	0	0	0	0	0	0	35
Annual Growth Rate	2.9%	2.9%	2.9%	2.9%	2.9%	2.9%	2.9%	2.9%	2.9%	2.9%	2.9%	2.9%
Committed Developments 1920 Alton Road		9										
2026 Background Traffic	0	696	23	0	1,176	0	0	0	0	0	0	38
1901 Alton			15									4
2026 Total Traffic	0	696	38	0	1,176	0	0	0	0	0	0	42

FUTURE TURNING MOVEMENT VOLUME ANALYSIS

**Alton Road and 19th Street
PM Peak Hour**

Description	Alton Road Northbound			Alton Road Southbound			19th Street Eastbound			19th Street Westbound		
	Left	Through	Right	Left	Through	Right	Left	Through	Right	Left	Through	Right
Existing Traffic (8/9/2023)	0	1,033	33	0	762	0	0	0	0	0	0	30
Season Adjustment Factor	1.05	1.05	1.05	1.05	1.05	1.05	1.05	1.05	1.05	1.05	1.05	1.05
2023 Peak Season Traffic	0	1,085	35	0	800	0	0	0	0	0	0	32
Annual Growth Rate	2.9%	2.9%	2.9%	2.9%	2.9%	2.9%	2.9%	2.9%	2.9%	2.9%	2.9%	2.9%
Committed Developments 1920 Alton Road		2			10							
2026 Background Traffic	0	1,185	38	0	883	0	0	0	0	0	0	34
1901 Alton			75									34
2026 Total Traffic	0	1,185	113	0	883	0	0	0	0	0	0	68

FUTURE TURNING MOVEMENT VOLUME ANALYSIS

**Alton Road and Dade Avenue
AM Peak Hour**

Description	Alton Road Northbound			Alton Road Southbound			Dade Avenue Eastbound			Dade Avenue Westbound		
	Left	Through	Right	Left	Through	Right	Left	Through	Right	Left	Through	Right
Existing Traffic (8/9/2023)	61	413	154	39	868	149	177	122	8	123	95	37
Season Adjustment Factor	1.05	1.05	1.05	1.05	1.05	1.05	1.05	1.05	1.05	1.05	1.05	1.05
2023 Peak Season Traffic	64	434	162	41	911	156	186	128	8	129	100	39
Annual Growth Rate	2.9%	2.9%	2.9%	2.9%	2.9%	2.9%	2.9%	2.9%	2.9%	2.9%	2.9%	2.9%
Committed Developments 1920 Alton Road		7										2
2026 Background Traffic	70	480	176	45	994	171	203	140	9	141	109	44
1901 Alton		6					5			3	3	4
2026 Total Traffic	70	486	176	45	994	171	208	140	9	144	112	48

FUTURE TURNING MOVEMENT VOLUME ANALYSIS

**Alton Road and Dade Avenue
PM Peak Hour**

Description	Alton Road Northbound			Alton Road Southbound			Dade Avenue Eastbound			Dade Avenue Westbound		
	Left	Through	Right	Left	Through	Right	Left	Through	Right	Left	Through	Right
Existing Traffic (8/9/2023)	67	783	182	46	703	90	199	142	18	160	166	43
Season Adjustment Factor	1.05	1.05	1.05	1.05	1.05	1.05	1.05	1.05	1.05	1.05	1.05	1.05
2023 Peak Season Traffic	70	822	191	48	738	95	209	149	19	168	174	45
Annual Growth Rate	2.9%	2.9%	2.9%	2.9%	2.9%	2.9%	2.9%	2.9%	2.9%	2.9%	2.9%	2.9%
Committed Developments 1920 Alton Road		2		2	8							
2026 Background Traffic	77	899	208	55	813	103	228	163	21	183	190	49
1901 Alton		31					28			30	27	24
2026 Total Traffic	77	930	208	55	813	103	256	163	21	213	217	73

FUTURE TURNING MOVEMENT VOLUME ANALYSIS

**Michigan Avenue and Dave Avenue
AM Peak Hour**

Description	Michigan Avenue Northbound			Michigan Avenue Southbound			19th Street Eastbound			Dade Avenue Westbound		
	Left	Through	Right	Left	Through	Right	Left	Through	Right	Left	Through	Right
Existing Traffic (8/9/2023)	0	288	0	411	0	17	0	0	0	0	237	245
Season Adjustment Factor	1.05	1.05	1.05	1.05	1.05	1.05	1.05	1.05	1.05	1.05	1.05	1.05
2023 Peak Season Traffic	0	302	0	432	0	18	0	0	0	0	249	257
Annual Growth Rate	2.9%	2.9%	2.9%	2.9%	2.9%	2.9%	2.9%	2.9%	2.9%	2.9%	2.9%	2.9%
Committed Developments 1920 Alton Road												
2026 Background Traffic	0	330	0	471	0	19	0	0	0	0	271	281
1901 Alton				3		6					4	
2026 Total Traffic	0	330	0	474	0	25	0	0	0	0	275	281

FUTURE TURNING MOVEMENT VOLUME ANALYSIS

**Michigan Avenue and Dave Avenue
PM Peak Hour**

Description	Michigan Avenue Northbound			Michigan Avenue Southbound			19th Street Eastbound			Dade Avenue Westbound		
	Left	Through	Right	Left	Through	Right	Left	Through	Right	Left	Through	Right
Existing Traffic (8/9/2023)	0	344	0	339	0	24	0	0	0	0	344	654
Season Adjustment Factor	1.05	1.05	1.05	1.05	1.05	1.05	1.05	1.05	1.05	1.05	1.05	1.05
2023 Peak Season Traffic	0	361	0	356	0	25	0	0	0	0	361	687
Annual Growth Rate	2.9%	2.9%	2.9%	2.9%	2.9%	2.9%	2.9%	2.9%	2.9%	2.9%	2.9%	2.9%
Committed Developments 1920 Alton Road												
2026 Background Traffic	0	394	0	388	0	27	0	0	0	0	394	749
1901 Alton				24		57					24	
2026 Total Traffic	0	394	0	412	0	84	0	0	0	0	418	749

FUTURE TURNING MOVEMENT VOLUME ANALYSIS

**Driveway and 19th Street
AM Peak Hour**

Description	Northbound			Driveway Southbound			19th Street Eastbound			19th Street Westbound		
	Left	Through	Right	Left	Through	Right	Left	Through	Right	Left	Through	Right
Existing Traffic (8/9/2023)	0	0	0	0	0		0	20		0	33	
Season Adjustment Factor	1.05	1.05	1.05	1.05	1.05	1.05	1.05	1.05	1.05	1.05	1.05	1.05
2023 Peak Season Traffic	0	0	0	0	0	0	0	21	0	0	35	0
Annual Growth Rate	2.9%	2.9%	2.9%	2.9%	2.9%	2.9%	2.9%	2.9%	2.9%	2.9%	2.9%	2.9%
Committed Developments 1920 Alton Road												
2026 Background Traffic	0	0	0	0	0	0	0	23	0	0	38	0
1901 Alton			0	29		12	41					19
2026 Total Traffic	0	0	0	29	0	12	41	23	0	0	38	19

FUTURE TURNING MOVEMENT VOLUME ANALYSIS





**Driveway and 19th Street
PM Peak Hour**

Description	Northbound			Driveway Southbound			19th Street Eastbound			19th Street Westbound		
	Left	Through	Right	Left	Through	Right	Left	Through	Right	Left	Through	Right
Existing Traffic (8/9/2023)	0			0		0	0	33		0	30	0
Season Adjustment Factor	1.05	1.05	1.05	1.05	1.05	1.05	1.05	1.05	1.05	1.05	1.05	1.05
2023 Peak Season Traffic	0	0	0	0	0	0	0	35	0	0	32	0
Annual Growth Rate	2.9%	2.9%	2.9%	2.9%	2.9%	2.9%	2.9%	2.9%	2.9%	2.9%	2.9%	2.9%
Committed Developments 1920 Alton Road												
2026 Background Traffic	0	0	0	0	0	0	0	38	0	0	34	0
1901 Alton				129		55	124					54
2026 Total Traffic	0	0	0	129	0	55	124	38	0	0	34	54



NOT TO SCALE

Legend

-  Study Roadway
-  Study Intersection
-  A.M. Peak Hour Trip Assignment
-  P.M. Peak Hour Trip Assignment

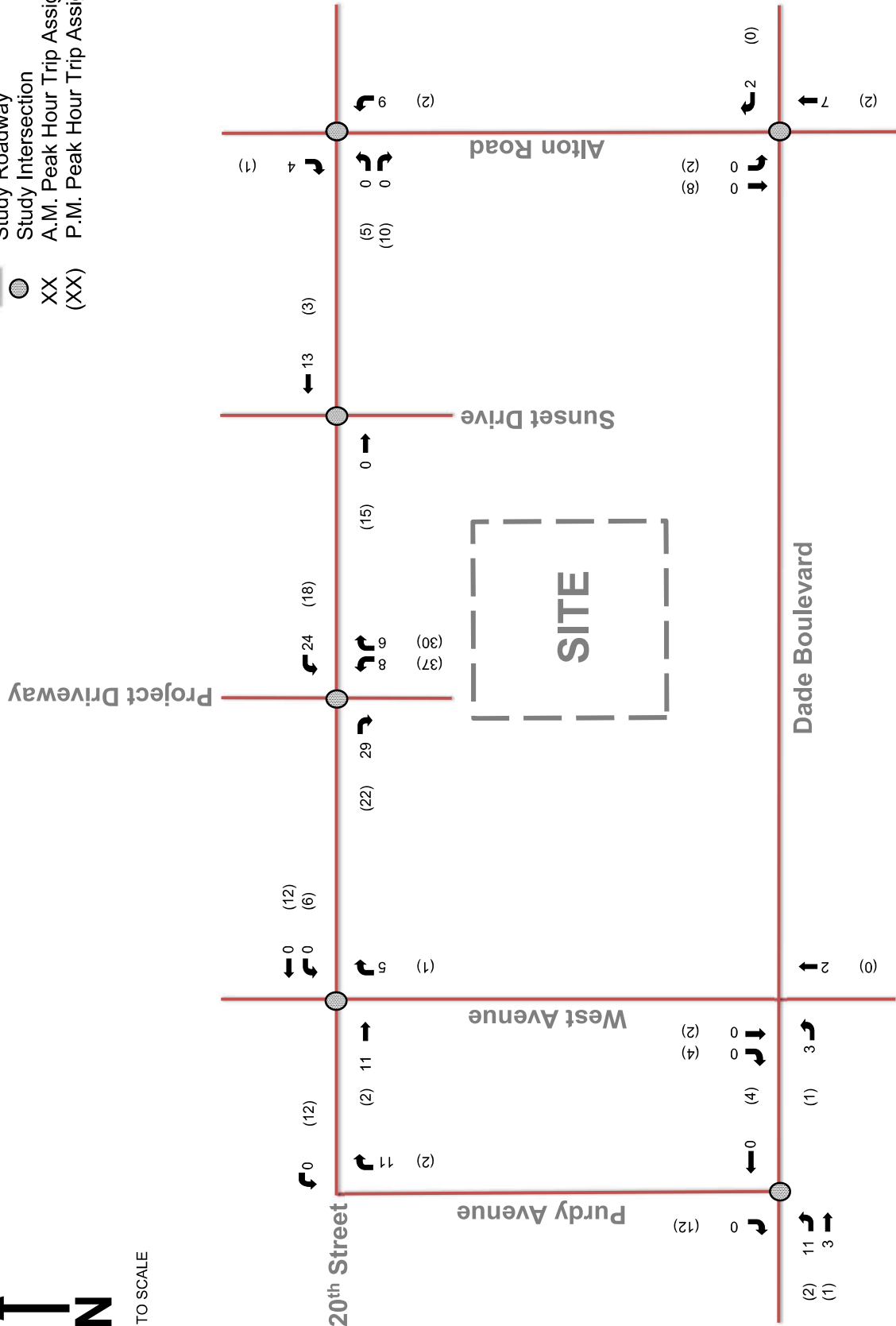

Figure 5
Peak Hour Project Trip Assignment
1920 Alton Road
Miami Beach, Florida

APPENDIX E

SYNCHRO Analyses

Timings

101: Alton Rd & N Michigan Ave



Lane Group	SEL	SET	NWL	NWT	NWR	NEL	NET	SWL	SWT
Lane Configurations		↕		↕	↕	↕	↕↔	↕↔	↕↔
Traffic Volume (vph)	14	8	18	3	229	7	647	412	1309
Future Volume (vph)	14	8	18	3	229	7	647	412	1309
Turn Type	Perm	NA	Perm	NA	Free	Prot	NA	Prot	NA
Protected Phases		8		4		1	6	5	2
Permitted Phases	8		4		Free				
Detector Phase	8	8	4	4		1	6	5	2
Switch Phase									
Minimum Initial (s)	7.0	7.0	7.0	7.0		5.0	14.0	5.0	14.0
Minimum Split (s)	36.3	36.3	36.3	36.3		10.7	27.0	10.7	27.0
Total Split (s)	36.3	36.3	36.3	36.3		38.7	75.0	38.7	75.0
Total Split (%)	24.2%	24.2%	24.2%	24.2%		25.8%	50.0%	25.8%	50.0%
Yellow Time (s)	4.0	4.0	4.0	4.0		3.7	4.0	3.7	4.0
All-Red Time (s)	2.3	2.3	2.3	2.3		2.0	2.0	2.0	2.0
Lost Time Adjust (s)		-1.0		-1.0		-1.0	-1.0	1.0	1.0
Total Lost Time (s)		5.3		5.3		4.7	5.0	6.7	7.0
Lead/Lag						Lead	Lag	Lead	Lag
Lead-Lag Optimize?						Yes	Yes	Yes	Yes
Recall Mode	None	None	None	None		None	C-Max	None	C-Max
Act Effct Green (s)		9.3		9.3	150.0	10.4	99.3	29.7	133.2
Actuated g/C Ratio		0.06		0.06	1.00	0.07	0.66	0.20	0.89
v/c Ratio		0.35		0.26	0.18	0.07	0.35	0.74	0.52
Control Delay		65.6		73.8	0.3	79.6	12.9	63.9	4.7
Queue Delay		0.0		0.0	0.0	0.0	0.3	0.0	0.1
Total Delay		65.6		73.8	0.3	79.6	13.2	63.9	4.8
LOS		E		E	A	E	B	E	A
Approach Delay		65.6		6.5			13.9		18.8
Approach LOS		E		A			B		B

Intersection Summary

Cycle Length: 150
 Actuated Cycle Length: 150
 Offset: 6 (4%), Referenced to phase 2:SWT and 6:NET, Start of Yellow
 Natural Cycle: 100
 Control Type: Actuated-Coordinated
 Maximum v/c Ratio: 0.74
 Intersection Signal Delay: 16.9
 Intersection LOS: B
 Intersection Capacity Utilization 68.7%
 ICU Level of Service C
 Analysis Period (min) 15

Splits and Phases: 101: Alton Rd & N Michigan Ave

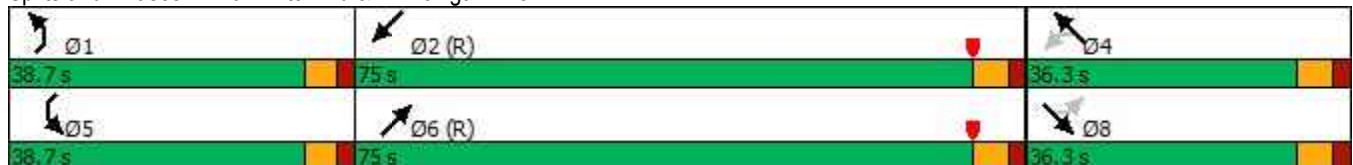

Queues

101: Alton Rd & N Michigan Ave





















Lane Group	SET	NWT	NWR	NEL	NET	SWL	SWT
Lane Group Flow (vph)	31	23	249	8	738	448	1444
v/c Ratio	0.35	0.26	0.18	0.07	0.35	0.74	0.52
Control Delay	65.6	73.8	0.3	79.6	12.9	63.9	4.7
Queue Delay	0.0	0.0	0.0	0.0	0.3	0.0	0.1
Total Delay	65.6	73.8	0.3	79.6	13.2	63.9	4.8
Queue Length 50th (ft)	23	22	0	8	228	214	144
Queue Length 95th (ft)	59	53	0	m27	312	261	402
Internal Link Dist (ft)	247	552			268		227
Turn Bay Length (ft)				100		265	
Base Capacity (vph)	282	295	1411	357	2108	675	2795
Starvation Cap Reductn	0	0	0	0	763	0	0
Spillback Cap Reductn	0	0	0	0	0	0	401
Storage Cap Reductn	0	0	0	0	0	0	0
Reduced v/c Ratio	0.11	0.08	0.18	0.02	0.55	0.66	0.60

Intersection Summary

m Volume for 95th percentile queue is metered by upstream signal.

HCM 6th Signalized Intersection Summary

101: Alton Rd & N Michigan Ave

												
Movement	SEL	SET	SER	NWL	NWT	NWR	NEL	NET	NER	SWL	SWT	SWR
Lane Configurations												
Traffic Volume (veh/h)	14	8	6	18	3	229	7	647	32	412	1309	19
Future Volume (veh/h)	14	8	6	18	3	229	7	647	32	412	1309	19
Initial Q (Qb), veh	0	0	0	0	0	0	0	0	0	0	0	0
Ped-Bike Adj(A_pbT)	0.99		0.97	0.99		1.00	1.00		0.99	1.00		0.97
Parking Bus, Adj	1.00	1.00	1.00	1.00	1.00	1.00	1.00	1.00	1.00	1.00	1.00	1.00
Work Zone On Approach		No			No			No			No	
Adj Sat Flow, veh/h/ln	1670	1670	1670	1670	1670	1670	1670	1670	1670	1670	1670	1670
Adj Flow Rate, veh/h	15	9	7	20	3	0	8	703	35	448	1423	21
Peak Hour Factor	0.92	0.92	0.92	0.92	0.92	0.92	0.92	0.92	0.92	0.92	0.92	0.92
Percent Heavy Veh, %	3	3	3	3	3	3	3	3	3	3	3	3
Cap, veh/h	68	36	20	116	14		26	2015	100	524	2589	38
Arrive On Green	0.06	0.06	0.05	0.06	0.06	0.00	0.03	1.00	1.00	0.17	0.81	0.82
Sat Flow, veh/h	520	584	322	1154	228	1415	1590	3074	153	3086	3199	47
Grp Volume(v), veh/h	31	0	0	23	0	0	8	363	375	448	705	739
Grp Sat Flow(s),veh/h/ln	1427	0	0	1381	0	1415	1590	1586	1640	1543	1586	1660
Q Serve(g_s), s	0.9	0.0	0.0	0.0	0.0	0.0	0.7	0.0	0.0	21.2	22.9	22.9
Cycle Q Clear(g_c), s	2.9	0.0	0.0	2.1	0.0	0.0	0.7	0.0	0.0	21.2	22.9	22.9
Prop In Lane	0.48		0.23	0.87		1.00	1.00		0.09	1.00		0.03
Lane Grp Cap(c), veh/h	123	0	0	130	0		26	1040	1075	524	1284	1343
V/C Ratio(X)	0.25	0.00	0.00	0.18	0.00		0.31	0.35	0.35	0.85	0.55	0.55
Avail Cap(c_a), veh/h	324	0	0	316	0		361	1040	1075	658	1284	1343
HCM Platoon Ratio	1.00	1.00	1.00	1.00	1.00	1.00	2.00	2.00	2.00	1.00	1.00	1.00
Upstream Filter(I)	1.00	0.00	0.00	1.00	0.00	0.00	0.97	0.97	0.97	1.00	1.00	1.00
Uniform Delay (d), s/veh	67.5	0.0	0.0	67.0	0.0	0.0	71.8	0.0	0.0	60.5	4.9	4.9
Incr Delay (d2), s/veh	0.8	0.0	0.0	0.5	0.0	0.0	22.7	0.9	0.9	14.3	1.7	1.6
Initial Q Delay(d3),s/veh	0.0	0.0	0.0	0.0	0.0	0.0	0.0	0.0	0.0	0.0	0.0	0.0
%ile BackOfQ(50%),veh/ln	1.2	0.0	0.0	0.9	0.0	0.0	0.5	0.3	0.3	9.3	6.8	7.1
Unsig. Movement Delay, s/veh												
LnGrp Delay(d),s/veh	68.3	0.0	0.0	67.5	0.0	0.0	94.4	0.9	0.9	74.8	6.6	6.5
LnGrp LOS	E	A	A	E	A		F	A	A	E	A	A
Approach Vol, veh/h		31			23			746			1892	
Approach Delay, s/veh		68.3			67.5			1.9			22.7	
Approach LOS		E			E			A			C	
Timer - Assigned Phs	1	2		4	5	6		8				
Phs Duration (G+Y+Rc), s	7.1	128.4		14.5	32.2	103.3		14.5				
Change Period (Y+Rc), s	* 5.7	6.0		* 6.3	* 5.7	6.0		* 6.3				
Max Green Setting (Gmax), s	* 33	69.0		* 30	* 33	69.0		* 30				
Max Q Clear Time (g_c+I1), s	2.7	24.9		4.1	23.2	2.0		4.9				
Green Ext Time (p_c), s	0.0	1.3		0.0	3.3	0.6		0.1				
Intersection Summary												
HCM 6th Ctrl Delay				17.9								
HCM 6th LOS				B								
Notes												
* HCM 6th computational engine requires equal clearance times for the phases crossing the barrier.												
Unsignalized Delay for [NWR] is excluded from calculations of the approach delay and intersection delay.												

Timings

102: Alton Rd & 20 St/Sunset Harbour Dr



Lane Group	EBL	EBT	EBR	WBT	NEL	NET	SWL	SWT	SWR
Lane Configurations									
Traffic Volume (vph)	132	3	14	3	100	539	26	1103	245
Future Volume (vph)	132	3	14	3	100	539	26	1103	245
Turn Type	Split	NA	Perm	NA	pm+pt	NA	Perm	NA	Perm
Protected Phases	3	3		4	1	6		2	
Permitted Phases			3		6		2		2
Detector Phase	3	3	3	4	1	6	2	2	2
Switch Phase									
Minimum Initial (s)	7.0	7.0	7.0	7.0	5.0	7.0	7.0	7.0	7.0
Minimum Split (s)	13.3	13.3	13.3	13.3	11.0	43.3	43.3	43.3	43.3
Total Split (s)	33.0	33.0	33.0	15.0	15.0	102.0	87.0	87.0	87.0
Total Split (%)	22.0%	22.0%	22.0%	10.0%	10.0%	68.0%	58.0%	58.0%	58.0%
Yellow Time (s)	4.0	4.0	4.0	4.0	4.0	4.0	4.0	4.0	4.0
All-Red Time (s)	2.3	2.3	2.3	2.3	2.0	3.3	3.3	3.3	3.3
Lost Time Adjust (s)	-1.3	0.0	-1.3	-1.3	1.0	1.0	-1.5	-1.5	-1.5
Total Lost Time (s)	5.0	6.3	5.0	5.0	7.0	8.3	5.8	5.8	5.8
Lead/Lag	Lead	Lead	Lead	Lag	Lead		Lag	Lag	Lag
Lead-Lag Optimize?	Yes	Yes	Yes	Yes	Yes		Yes	Yes	Yes
Recall Mode	None	None	None	None	None	C-Max	C-Max	C-Max	C-Max
Act Effct Green (s)	13.8	12.5	13.8	8.4	118.7	117.4	106.3	106.3	106.3
Actuated g/C Ratio	0.09	0.08	0.09	0.06	0.79	0.78	0.71	0.71	0.71
v/c Ratio	0.55	0.62	0.07	0.12	0.42	0.25	0.06	0.56	0.28
Control Delay	79.3	85.9	0.6	49.5	9.6	5.7	9.2	15.0	7.2
Queue Delay	0.0	0.0	0.0	0.0	0.0	0.0	0.0	0.5	0.8
Total Delay	79.3	85.9	0.6	49.5	9.6	5.7	9.2	15.4	8.0
LOS	E	F	A	D	A	A	A	B	A
Approach Delay		74.8		49.5		6.3		14.0	
Approach LOS		E		D		A		B	

Intersection Summary

Cycle Length: 150

Actuated Cycle Length: 150

Offset: 23 (15%), Referenced to phase 2:SWTL and 6:NETL, Start of Yellow

Natural Cycle: 85

Control Type: Actuated-Coordinated

Maximum v/c Ratio: 0.62

Intersection Signal Delay: 16.0

Intersection LOS: B

Intersection Capacity Utilization 66.8%

ICU Level of Service C

Analysis Period (min) 15

Splits and Phases: 102: Alton Rd & 20 St/Sunset Harbour Dr

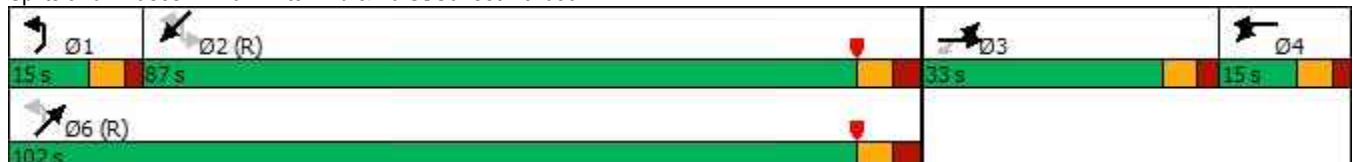

Queues

102: Alton Rd & 20 St/Sunset Harbour Dr



Lane Group	EBL	EBT	EBR	WBT	NEL	NET	SWL	SWT	SWR
Lane Group Flow (vph)	76	77	16	11	114	626	30	1253	278
v/c Ratio	0.55	0.62	0.07	0.12	0.42	0.25	0.06	0.56	0.28
Control Delay	79.3	85.9	0.6	49.5	9.6	5.7	9.2	15.0	7.2
Queue Delay	0.0	0.0	0.0	0.0	0.0	0.0	0.0	0.5	0.8
Total Delay	79.3	85.9	0.6	49.5	9.6	5.7	9.2	15.4	8.0
Queue Length 50th (ft)	75	77	0	5	17	60	9	320	69
Queue Length 95th (ft)	127	130	0	26	54	139	m25	571	178
Internal Link Dist (ft)		175		136		403		268	
Turn Bay Length (ft)					270		110		120
Base Capacity (vph)	279	267	358	107	289	2463	486	2234	1007
Starvation Cap Reductn	0	0	0	0	0	0	0	499	454
Spillback Cap Reductn	0	0	0	0	0	73	0	0	0
Storage Cap Reductn	0	0	0	0	0	0	0	0	0
Reduced v/c Ratio	0.27	0.29	0.04	0.10	0.39	0.26	0.06	0.72	0.50

Intersection Summary

m Volume for 95th percentile queue is metered by upstream signal.

HCM Signalized Intersection Capacity Analysis

102: Alton Rd & 20 St/Sunset Harbour Dr



Movement	EBL	EBT	EBR	WBL	WBT	WBR	NEL	NET	NER	SWL	SWT	SWR
Lane Configurations												
Traffic Volume (vph)	132	3	14	2	3	5	100	539	11	26	1103	245
Future Volume (vph)	132	3	14	2	3	5	100	539	11	26	1103	245
Ideal Flow (vphpl)	1900	1900	1900	1900	1900	1900	1900	1900	1900	1900	1900	1900
Total Lost time (s)	5.0	6.3	5.0		5.0		7.0	8.3		5.8	5.8	5.8
Lane Util. Factor	0.95	0.95	1.00		1.00		1.00	0.95		1.00	0.95	1.00
Frpb, ped/bikes	1.00	1.00	0.98		1.00		1.00	1.00		1.00	1.00	0.97
Flpb, ped/bikes	1.00	1.00	1.00		1.00		1.00	1.00		1.00	1.00	1.00
Frt	1.00	1.00	0.85		0.93		1.00	1.00		1.00	1.00	0.85
Flt Protected	0.95	0.95	1.00		0.99		0.95	1.00		0.95	1.00	1.00
Satd. Flow (prot)	1498	1505	1390		1524		1577	3145		1577	3154	1372
Flt Permitted	0.95	0.95	1.00		0.99		0.16	1.00		0.41	1.00	1.00
Satd. Flow (perm)	1498	1505	1390		1524		270	3145		688	3154	1372
Peak-hour factor, PHF	0.88	0.88	0.88	0.88	0.88	0.88	0.88	0.88	0.88	0.88	0.88	0.88
Adj. Flow (vph)	150	3	16	2	3	6	114	612	12	30	1253	278
RTOR Reduction (vph)	0	0	15	0	6	0	0	1	0	0	0	41
Lane Group Flow (vph)	76	77	1	0	5	0	114	625	0	30	1253	237
Confl. Peds. (#/hr)			1	1			1					1
Confl. Bikes (#/hr)												10
Turn Type	Split	NA	Perm	Split	NA		pm+pt	NA		Perm	NA	Perm
Protected Phases	3	3		4	4		1	6			2	
Permitted Phases			3				6			2		2
Actuated Green, G (s)	12.5	12.5	12.5		2.9		114.7	114.7		101.0	101.0	101.0
Effective Green, g (s)	13.8	12.5	13.8		4.2		113.7	113.7		102.5	102.5	102.5
Actuated g/C Ratio	0.09	0.08	0.09		0.03		0.76	0.76		0.68	0.68	0.68
Clearance Time (s)	6.3	6.3	6.3		6.3		6.0	7.3		7.3	7.3	7.3
Vehicle Extension (s)	2.5	2.5	2.5		2.5		2.0	1.0		1.0	1.0	1.0
Lane Grp Cap (vph)	137	125	127		42		263	2383		470	2155	937
v/s Ratio Prot	0.05	c0.05			c0.00		c0.02	0.20			c0.40	
v/s Ratio Perm			0.00				0.31			0.04		0.17
v/c Ratio	0.55	0.62	0.01		0.12		0.43	0.26		0.06	0.58	0.25
Uniform Delay, d1	65.2	66.4	61.9		71.1		8.7	5.5		7.9	12.5	9.1
Progression Factor	1.00	1.00	1.00		1.00		1.00	1.00		0.88	1.09	1.18
Incremental Delay, d2	3.9	7.5	0.0		1.0		0.4	0.3		0.2	1.0	0.6
Delay (s)	69.0	73.9	61.9		72.1		9.1	5.8		7.2	14.7	11.3
Level of Service	E	E	E		E		A	A		A	B	B
Approach Delay (s)		70.6			72.1			6.3			13.9	
Approach LOS		E			E			A			B	
Intersection Summary												
HCM 2000 Control Delay			15.8			HCM 2000 Level of Service			B			
HCM 2000 Volume to Capacity ratio			0.56									
Actuated Cycle Length (s)			150.0			Sum of lost time (s)			24.1			
Intersection Capacity Utilization			66.8%			ICU Level of Service			C			
Analysis Period (min)			15									
c Critical Lane Group												

HCM 6th Signalized Intersection Summary
102: Alton Rd & 20 St/Sunset Harbour Dr

HCM 6th Edition methodology expects strict NEMA phasing.

HCM 6th TWSC
103: Alton Rd & 19 St

Intersection

Int Delay, s/veh 0.2

Movement	WBL	WBR	NBT	NBR	SBL	SBT
Lane Configurations		↑	↑↑			↑↑
Traffic Vol, veh/h	0	35	630	21	0	1078
Future Vol, veh/h	0	35	630	21	0	1078
Conflicting Peds, #/hr	0	0	0	0	0	0
Sign Control	Stop	Stop	Free	Free	Free	Free
RT Channelized	-	None	-	None	-	None
Storage Length	-	0	-	-	-	-
Veh in Median Storage, #	0	-	0	-	-	0
Grade, %	0	-	0	-	-	0
Peak Hour Factor	92	92	92	92	92	92
Heavy Vehicles, %	3	3	3	3	3	3
Mvmt Flow	0	38	685	23	0	1172

Major/Minor	Minor1	Major1	Major2
Conflicting Flow All	-	354	0
Stage 1	-	-	-
Stage 2	-	-	-
Critical Hdwy	-	4.5	-
Critical Hdwy Stg 1	-	-	-
Critical Hdwy Stg 2	-	-	-
Follow-up Hdwy	-	3	-
Pot Cap-1 Maneuver	0	890	-
Stage 1	0	-	-
Stage 2	0	-	-
Platoon blocked, %			
Mov Cap-1 Maneuver	-	890	-
Mov Cap-2 Maneuver	-	-	-
Stage 1	-	-	-
Stage 2	-	-	-

Approach	WB	NB	SB
HCM Control Delay, s	9.2	0	0
HCM LOS	A		

Minor Lane/Major Mvmt	NBT	NBRWBLn1	SBT
Capacity (veh/h)	-	-	890
HCM Lane V/C Ratio	-	-	0.043
HCM Control Delay (s)	-	-	9.2
HCM Lane LOS	-	-	A
HCM 95th %tile Q(veh)	-	-	0.1

Timings

104: Alton Road & Dade Boulevard



Lane Group	EBL	EBT	WBL	WBT	WBR	NBL	NBT	SBL	SBT	SBR
Lane Configurations										
Traffic Volume (vph)	186	128	129	100	39	64	434	41	911	156
Future Volume (vph)	186	128	129	100	39	64	434	41	911	156
Turn Type	pm+pt	NA	pm+pt	NA	Perm	pm+pt	NA	Prot	NA	pm+ov
Protected Phases	3	8	7	4		1	6	5	2	3
Permitted Phases	8		4		4	6				2
Detector Phase	3	8	7	4	4	1	6	5	2	3
Switch Phase										
Minimum Initial (s)	5.0	7.0	5.0	7.0	7.0	5.0	4.0	5.0	4.0	5.0
Minimum Split (s)	11.0	37.0	11.0	37.0	37.0	11.0	29.0	11.0	29.0	11.0
Total Split (s)	16.0	37.0	20.0	40.0	40.0	17.0	76.0	17.0	76.0	16.0
Total Split (%)	10.7%	24.7%	13.3%	26.7%	26.7%	11.3%	50.7%	11.3%	50.7%	10.7%
Yellow Time (s)	3.7	4.0	3.7	4.0	4.0	3.7	4.0	3.7	4.0	3.7
All-Red Time (s)	2.0	2.0	2.0	2.0	2.0	2.0	2.0	2.0	2.0	2.0
Lost Time Adjust (s)	0.0	0.0	0.0	0.0	0.0	0.0	0.0	0.0	0.0	0.0
Total Lost Time (s)	5.7	6.0	5.7	6.0	6.0	5.7	6.0	5.7	6.0	5.7
Lead/Lag	Lead	Lag	Lead	Lag	Lag	Lead	Lag	Lead	Lag	Lead
Lead-Lag Optimize?	Yes	Yes	Yes	Yes	Yes	Yes	Yes	Yes	Yes	Yes
Recall Mode	None	None	None	None	None	None	C-Max	None	C-Max	None
Act Effct Green (s)	22.5	11.9	28.7	15.0	15.0	100.6	94.7	8.7	96.9	107.5
Actuated g/C Ratio	0.15	0.08	0.19	0.10	0.10	0.67	0.63	0.06	0.65	0.72
v/c Ratio	1.02	0.60	0.63	0.35	0.19	0.22	0.34	0.49	0.49	0.17
Control Delay	125.4	74.6	64.0	64.9	1.8	9.0	13.8	85.4	16.0	4.5
Queue Delay	0.0	0.0	0.0	0.0	0.0	0.0	0.0	0.0	0.0	0.0
Total Delay	125.4	74.6	64.0	64.9	1.8	9.0	13.8	85.4	16.0	4.5
LOS	F	E	E	E	A	A	B	F	B	A
Approach Delay		103.9		55.3			13.3		16.9	
Approach LOS		F		E			B		B	

Intersection Summary

Cycle Length: 150

Actuated Cycle Length: 150

Offset: 25 (17%), Referenced to phase 2:SBT and 6:NBTL, Start of Yellow

Natural Cycle: 90

Control Type: Actuated-Coordinated

Maximum v/c Ratio: 1.02

Intersection Signal Delay: 32.2

Intersection LOS: C

Intersection Capacity Utilization 70.2%

ICU Level of Service C

Analysis Period (min) 15

Splits and Phases: 104: Alton Road & Dade Boulevard

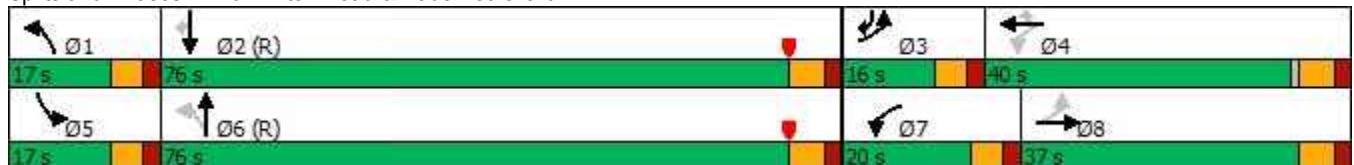

Queues

104: Alton Road & Dade Boulevard



Lane Group	EBL	EBT	WBL	WBT	WBR	NBL	NBT	SBL	SBT	SBR
Lane Group Flow (vph)	204	150	142	110	43	70	655	45	1001	171
v/c Ratio	1.02	0.60	0.63	0.35	0.19	0.22	0.34	0.49	0.49	0.17
Control Delay	125.4	74.6	64.0	64.9	1.8	9.0	13.8	85.4	16.0	4.5
Queue Delay	0.0	0.0	0.0	0.0	0.0	0.0	0.0	0.0	0.0	0.0
Total Delay	125.4	74.6	64.0	64.9	1.8	9.0	13.8	85.4	16.0	4.5
Queue Length 50th (ft)	~186	74	121	53	0	19	147	44	268	27
Queue Length 95th (ft)	#335	111	186	84	0	38	213	86	359	58
Internal Link Dist (ft)		316		456			473		500	
Turn Bay Length (ft)	220		185		60	350		185		70
Base Capacity (vph)	200	647	235	735	400	363	1906	121	2036	1001
Starvation Cap Reductn	0	0	0	0	0	0	0	0	0	0
Spillback Cap Reductn	0	0	0	0	0	0	0	0	0	0
Storage Cap Reductn	0	0	0	0	0	0	0	0	0	0
Reduced v/c Ratio	1.02	0.23	0.60	0.15	0.11	0.19	0.34	0.37	0.49	0.17

Intersection Summary

~ Volume exceeds capacity, queue is theoretically infinite.























Queue shown is maximum after two cycles.

95th percentile volume exceeds capacity, queue may be longer.

Queue shown is maximum after two cycles.

HCM 6th Signalized Intersection Summary

104: Alton Road & Dade Boulevard

												
Movement	EBL	EBT	EBR	WBL	WBT	WBR	NBL	NBT	NBR	SBL	SBT	SBR
Lane Configurations												
Traffic Volume (veh/h)	186	128	8	129	100	39	64	434	162	41	911	156
Future Volume (veh/h)	186	128	8	129	100	39	64	434	162	41	911	156
Initial Q (Qb), veh	0	0	0	0	0	0	0	0	0	0	0	0
Ped-Bike Adj(A_pbT)	0.98		1.00	0.99		1.00	1.00		0.98	1.00		0.98
Parking Bus, Adj	1.00	1.00	1.00	1.00	1.00	1.00	1.00	1.00	1.00	1.00	1.00	1.00
Work Zone On Approach		No			No			No			No	
Adj Sat Flow, veh/h/ln	1670	1670	1670	1670	1670	1670	1670	1670	1670	1670	1670	1670
Adj Flow Rate, veh/h	204	141	0	142	110	0	70	477	178	45	1001	171
Peak Hour Factor	0.91	0.91	0.91	0.91	0.91	0.91	0.91	0.91	0.91	0.91	0.91	0.91
Percent Heavy Veh, %	3	3	3	3	3	3	3	3	3	3	3	3
Cap, veh/h	254	295		252	372		292	1403	520	56	1988	965
Arrive On Green	0.07	0.09	0.00	0.09	0.12	0.00	0.03	0.62	0.62	0.04	0.63	0.63
Sat Flow, veh/h	1590	3256	0	1590	3173	1415	1590	2252	834	1590	3173	1385
Grp Volume(v), veh/h	204	141	0	142	110	0	70	335	320	45	1001	171
Grp Sat Flow(s),veh/h/ln	1590	1586	0	1590	1586	1415	1590	1586	1500	1590	1586	1385
Q Serve(g_s), s	10.3	6.3	0.0	12.0	4.8	0.0	2.4	15.1	15.3	4.2	25.8	6.4
Cycle Q Clear(g_c), s	10.3	6.3	0.0	12.0	4.8	0.0	2.4	15.1	15.3	4.2	25.8	6.4
Prop In Lane	1.00		0.00	1.00		1.00	1.00		0.56	1.00		1.00
Lane Grp Cap(c), veh/h	254	295		252	372		292	988	935	56	1988	965
V/C Ratio(X)	0.80	0.48		0.56	0.30		0.24	0.34	0.34	0.81	0.50	0.18
Avail Cap(c_a), veh/h	254	656		255	719		362	988	935	120	1988	965
HCM Platoon Ratio	1.00	1.00	1.00	1.00	1.00	1.00	1.00	1.00	1.00	1.00	1.00	1.00
Upstream Filter(I)	1.00	1.00	0.00	1.00	1.00	0.00	1.00	1.00	1.00	1.00	1.00	1.00
Uniform Delay (d), s/veh	61.8	64.6	0.0	54.7	60.6	0.0	11.9	13.5	13.5	71.9	15.3	7.9
Incr Delay (d2), s/veh	15.9	0.9	0.0	1.7	0.3	0.0	0.2	0.9	1.0	9.6	0.9	0.4
Initial Q Delay(d3),s/veh	0.0	0.0	0.0	0.0	0.0	0.0	0.0	0.0	0.0	0.0	0.0	0.0
%ile BackOfQ(50%),veh/ln	4.3	2.6	0.0	4.9	1.9	0.0	0.9	5.7	5.5	1.9	9.5	2.0
Unsig. Movement Delay, s/veh												
LnGrp Delay(d),s/veh	77.6	65.5	0.0	56.4	60.9	0.0	12.1	14.4	14.5	81.5	16.2	8.3
LnGrp LOS	E	E		E	E		B	B	B	F	B	A
Approach Vol, veh/h		345			252			725			1217	
Approach Delay, s/veh		72.7			58.4			14.3			17.5	
Approach LOS		E			E			B			B	
Timer - Assigned Phs	1	2	3	4	5	6	7	8				
Phs Duration (G+Y+Rc), s	10.4	100.0	16.0	23.6	11.0	99.5	19.6	19.9				
Change Period (Y+Rc), s	* 5.7	6.0	* 5.7	6.0	* 5.7	6.0	* 5.7	6.0				
Max Green Setting (Gmax), s	* 11	70.0	* 10	34.0	* 11	70.0	* 14	31.0				
Max Q Clear Time (g_c+I1), s	4.4	27.8	12.3	6.8	6.2	17.3	14.0	8.3				
Green Ext Time (p_c), s	0.0	3.1	0.0	0.5	0.0	1.5	0.0	0.6				
Intersection Summary												
HCM 6th Ctrl Delay				28.1								
HCM 6th LOS				C								
Notes												
* HCM 6th computational engine requires equal clearance times for the phases crossing the barrier.												
Unsignalized Delay for [EBR, WBR] is excluded from calculations of the approach delay and intersection delay.												

Timings

105: Dade Blvd & Michigan Ave



Lane Group	EBT	WBT	WBR	SEL	SER	Ø3
Lane Configurations	↑↑	↑↑	↑	↑↑	↑	
Traffic Volume (vph)	302	249	257	432	18	
Future Volume (vph)	302	249	257	432	18	
Turn Type	NA	NA	pm+ov	Prot	Perm	
Protected Phases	6	2	4	4		3
Permitted Phases			2		4	
Detector Phase	6	2	4	4	4	
Switch Phase						
Minimum Initial (s)	14.0	14.0	7.0	7.0	7.0	1.0
Minimum Split (s)	36.0	36.0	20.6	20.6	20.6	27.0
Total Split (s)	39.0	39.0	54.0	54.0	54.0	27.0
Total Split (%)	32.5%	32.5%	45.0%	45.0%	45.0%	23%
Yellow Time (s)	4.0	4.0	4.0	4.0	4.0	2.0
All-Red Time (s)	2.0	2.0	2.0	2.0	2.0	0.0
Lost Time Adjust (s)	0.0	0.0	0.0	0.0	0.0	
Total Lost Time (s)	6.0	6.0	6.0	6.0	6.0	
Lead/Lag			Lag	Lag	Lag	Lead
Lead-Lag Optimize?			Yes	Yes	Yes	Yes
Recall Mode	C-Max	C-Max	None	None	None	None
Act Effect Green (s)	81.9	81.9	120.0	26.1	26.1	
Actuated g/C Ratio	0.68	0.68	1.00	0.22	0.22	
v/c Ratio	0.15	0.13	0.20	0.71	0.06	
Control Delay	7.5	7.4	0.3	48.7	12.8	
Queue Delay	0.0	0.0	0.0	0.0	0.0	
Total Delay	7.5	7.4	0.3	48.7	12.8	
LOS	A	A	A	D	B	
Approach Delay	7.5	3.8		47.3		
Approach LOS	A	A		D		

Intersection Summary

Cycle Length: 120

Actuated Cycle Length: 120

Offset: 117 (98%), Referenced to phase 2:WBT and 6:EBT, Start of Yellow

Natural Cycle: 85

Control Type: Actuated-Coordinated

Maximum v/c Ratio: 0.71

Intersection Signal Delay: 20.2

Intersection LOS: C

Intersection Capacity Utilization 34.0%

ICU Level of Service A

Analysis Period (min) 15

Splits and Phases: 105: Dade Blvd & Michigan Ave

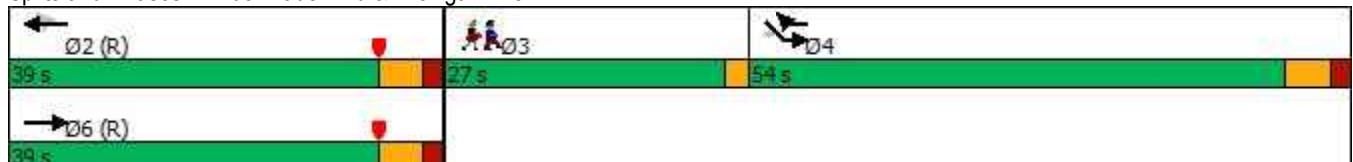

Queues

105: Dade Blvd & Michigan Ave



Lane Group	EBT	WBT	WBR	SEL	SER
Lane Group Flow (vph)	368	304	313	527	22
v/c Ratio	0.15	0.13	0.20	0.71	0.06
Control Delay	7.5	7.4	0.3	48.7	12.8
Queue Delay	0.0	0.0	0.0	0.0	0.0
Total Delay	7.5	7.4	0.3	48.7	12.8
Queue Length 50th (ft)	48	39	0	195	0
Queue Length 95th (ft)	72	60	0	212	17
Internal Link Dist (ft)	166	341		11	
Turn Bay Length (ft)			280		
Base Capacity (vph)	2392	2392	1568	1360	640
Starvation Cap Reductn	0	0	0	0	0
Spillback Cap Reductn	0	0	0	0	0
Storage Cap Reductn	0	0	0	0	0
Reduced v/c Ratio	0.15	0.13	0.20	0.39	0.03

Intersection Summary

HCM Signalized Intersection Capacity Analysis

105: Dade Blvd & Michigan Ave



Movement	EBL	EBT	WBT	WBR	SEL	SER
Lane Configurations		↑↑	↑↑	↑	↑↑	↑
Traffic Volume (vph)	0	302	249	257	432	18
Future Volume (vph)	0	302	249	257	432	18
Ideal Flow (vphpl)	1900	1900	1900	1900	1900	1900
Total Lost time (s)		6.0	6.0	6.0	6.0	6.0
Lane Util. Factor		0.95	0.95	1.00	0.97	1.00
Frbp, ped/bikes		1.00	1.00	1.00	1.00	1.00
Flpb, ped/bikes		1.00	1.00	1.00	1.00	1.00
Frt		1.00	1.00	0.85	1.00	0.85
Flt Protected		1.00	1.00	1.00	0.95	1.00
Satd. Flow (prot)		3505	3505	1568	3400	1568
Flt Permitted		1.00	1.00	1.00	0.95	1.00
Satd. Flow (perm)		3505	3505	1568	3400	1568
Peak-hour factor, PHF	0.82	0.82	0.82	0.82	0.82	0.82
Adj. Flow (vph)	0	368	304	313	527	22
RTOR Reduction (vph)	0	0	0	31	0	17
Lane Group Flow (vph)	0	368	304	282	527	5
Confl. Peds. (#/hr)	4					
Turn Type		NA	NA	pm+ov	Prot	Perm
Protected Phases		6	2	4	4	
Permitted Phases				2		4
Actuated Green, G (s)		81.9	81.9	108.0	26.1	26.1
Effective Green, g (s)		81.9	81.9	108.0	26.1	26.1
Actuated g/C Ratio		0.68	0.68	0.90	0.22	0.22
Clearance Time (s)		6.0	6.0	6.0	6.0	6.0
Vehicle Extension (s)		1.0	1.0	3.5	3.5	3.5
Lane Grp Cap (vph)		2392	2392	1568	739	341
v/s Ratio Prot		0.10	0.09	c0.04	c0.16	
v/s Ratio Perm				0.14		0.00
v/c Ratio		0.15	0.13	0.18	0.71	0.01
Uniform Delay, d1		6.8	6.6	0.7	43.5	36.9
Progression Factor		1.00	1.00	1.00	1.00	1.00
Incremental Delay, d2		0.1	0.1	0.1	3.4	0.0
Delay (s)		6.9	6.7	0.8	46.9	36.9
Level of Service		A	A	A	D	D
Approach Delay (s)		6.9	3.7		46.5	
Approach LOS		A	A		D	
Intersection Summary						
HCM 2000 Control Delay			19.8		HCM 2000 Level of Service	B
HCM 2000 Volume to Capacity ratio			0.32			
Actuated Cycle Length (s)			120.0		Sum of lost time (s)	14.0
Intersection Capacity Utilization			34.0%		ICU Level of Service	A
Analysis Period (min)			15			
c Critical Lane Group						

HCM 6th Signalized Intersection Summary
105: Dade Blvd & Michigan Ave

HCM 6th Edition methodology does not support exclusive ped or hold phases.

Timings

101: Alton Rd & N Michigan Ave



Lane Group	SEL	SET	NWL	NWT	NWR	NEL	NET	SWL	SWT
Lane Configurations									
Traffic Volume (vph)	15	9	19	3	250	8	705	449	1428
Future Volume (vph)	15	9	19	3	250	8	705	449	1428
Turn Type	Perm	NA	Perm	NA	Free	Prot	NA	Prot	NA
Protected Phases		8		4		1	6	5	2
Permitted Phases	8		4		Free				
Detector Phase	8	8	4	4		1	6	5	2
Switch Phase									
Minimum Initial (s)	7.0	7.0	7.0	7.0		5.0	14.0	5.0	14.0
Minimum Split (s)	36.3	36.3	36.3	36.3		10.7	27.0	10.7	27.0
Total Split (s)	36.3	36.3	36.3	36.3		38.7	75.0	38.7	75.0
Total Split (%)	24.2%	24.2%	24.2%	24.2%		25.8%	50.0%	25.8%	50.0%
Yellow Time (s)	4.0	4.0	4.0	4.0		3.7	4.0	3.7	4.0
All-Red Time (s)	2.3	2.3	2.3	2.3		2.0	2.0	2.0	2.0
Lost Time Adjust (s)		-1.0		-1.0		-1.0	-1.0	1.0	1.0
Total Lost Time (s)		5.3		5.3		4.7	5.0	6.7	7.0
Lead/Lag						Lead	Lag	Lead	Lag
Lead-Lag Optimize?						Yes	Yes	Yes	Yes
Recall Mode	None	None	None	None		None	C-Max	None	C-Max
Act Effct Green (s)		9.5		9.5	150.0	10.5	94.5	31.7	128.9
Actuated g/C Ratio		0.06		0.06	1.00	0.07	0.63	0.21	0.86
v/c Ratio		0.37		0.28	0.19	0.08	0.40	0.76	0.58
Control Delay		65.5		74.2	0.3	78.6	15.9	63.1	5.9
Queue Delay		0.0		0.0	0.0	0.0	0.4	0.0	0.4
Total Delay		65.5		74.2	0.3	78.6	16.3	63.1	6.3
LOS		E		E	A	E	B	E	A
Approach Delay		65.5		6.3			17.0		19.7
Approach LOS		E		A			B		B

Intersection Summary

Cycle Length: 150
 Actuated Cycle Length: 150
 Offset: 6 (4%), Referenced to phase 2:SWT and 6:NET, Start of Yellow
 Natural Cycle: 100
 Control Type: Actuated-Coordinated
 Maximum v/c Ratio: 0.76
 Intersection Signal Delay: 18.3
 Intersection Capacity Utilization 72.6%
 Analysis Period (min) 15

Intersection LOS: B
 ICU Level of Service C

Splits and Phases: 101: Alton Rd & N Michigan Ave

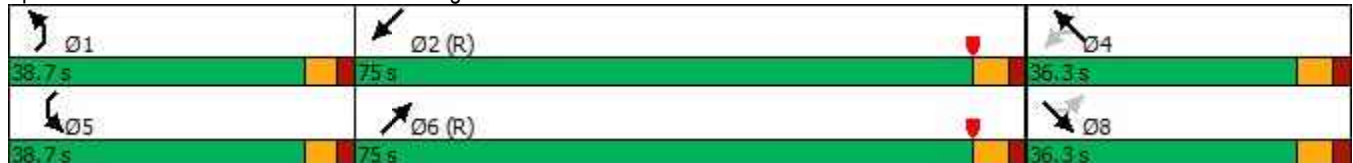

Queues

101: Alton Rd & N Michigan Ave





















Lane Group	SET	NWT	NWR	NEL	NET	SWL	SWT
Lane Group Flow (vph)	34	24	272	9	803	488	1575
v/c Ratio	0.37	0.28	0.19	0.08	0.40	0.76	0.58
Control Delay	65.5	74.2	0.3	78.6	15.9	63.1	5.9
Queue Delay	0.0	0.0	0.0	0.0	0.4	0.0	0.4
Total Delay	65.5	74.2	0.3	78.6	16.3	63.1	6.3
Queue Length 50th (ft)	25	23	0	9	261	232	173
Queue Length 95th (ft)	62	54	0	m29	352	279	483
Internal Link Dist (ft)	247	552			268		227
Turn Bay Length (ft)				100		265	
Base Capacity (vph)	283	287	1411	357	2006	691	2705
Starvation Cap Reductn	0	0	0	0	670	0	0
Spillback Cap Reductn	0	0	0	0	0	0	542
Storage Cap Reductn	0	0	0	0	0	0	0
Reduced v/c Ratio	0.12	0.08	0.19	0.03	0.60	0.71	0.73

Intersection Summary

m Volume for 95th percentile queue is metered by upstream signal.

HCM 6th Signalized Intersection Summary

101: Alton Rd & N Michigan Ave

												
Movement	SEL	SET	SER	NWL	NWT	NWR	NEL	NET	NER	SWL	SWT	SWR
Lane Configurations												
Traffic Volume (veh/h)	15	9	7	19	3	250	8	705	34	449	1428	21
Future Volume (veh/h)	15	9	7	19	3	250	8	705	34	449	1428	21
Initial Q (Qb), veh	0	0	0	0	0	0	0	0	0	0	0	0
Ped-Bike Adj(A_pbT)	0.99		0.97	0.99		1.00	1.00		0.99	1.00		0.97
Parking Bus, Adj	1.00	1.00	1.00	1.00	1.00	1.00	1.00	1.00	1.00	1.00	1.00	1.00
Work Zone On Approach		No			No			No			No	
Adj Sat Flow, veh/h/ln	1670	1670	1670	1670	1670	1670	1670	1670	1670	1670	1670	1670
Adj Flow Rate, veh/h	16	10	8	21	3	0	9	766	37	488	1552	23
Peak Hour Factor	0.92	0.92	0.92	0.92	0.92	0.92	0.92	0.92	0.92	0.92	0.92	0.92
Percent Heavy Veh, %	3	3	3	3	3	3	3	3	3	3	3	3
Cap, veh/h	66	37	21	118	14		27	1981	96	559	2583	38
Arrive On Green	0.06	0.06	0.06	0.06	0.06	0.00	0.03	1.00	1.00	0.18	0.81	0.81
Sat Flow, veh/h	501	592	336	1169	218	1415	1590	3079	149	3086	3199	47
Grp Volume(v), veh/h	34	0	0	24	0	0	9	395	408	488	769	806
Grp Sat Flow(s),veh/h/ln	1430	0	0	1388	0	1415	1590	1586	1641	1543	1586	1660
Q Serve(g_s), s	1.1	0.0	0.0	0.0	0.0	0.0	0.8	0.0	0.0	23.1	27.1	27.2
Cycle Q Clear(g_c), s	3.2	0.0	0.0	2.1	0.0	0.0	0.8	0.0	0.0	23.1	27.1	27.2
Prop In Lane	0.47		0.24	0.87		1.00	1.00		0.09	1.00		0.03
Lane Grp Cap(c), veh/h	124	0	0	131	0		27	1021	1056	559	1281	1340
V/C Ratio(X)	0.27	0.00	0.00	0.18	0.00		0.33	0.39	0.39	0.87	0.60	0.60
Avail Cap(c_a), veh/h	324	0	0	316	0		361	1021	1056	658	1281	1340
HCM Platoon Ratio	1.00	1.00	1.00	1.00	1.00	1.00	2.00	2.00	2.00	1.00	1.00	1.00
Upstream Filter(I)	1.00	0.00	0.00	1.00	0.00	0.00	0.96	0.96	0.96	1.00	1.00	1.00
Uniform Delay (d), s/veh	67.6	0.0	0.0	67.0	0.0	0.0	71.6	0.0	0.0	59.7	5.4	5.4
Incr Delay (d2), s/veh	0.9	0.0	0.0	0.5	0.0	0.0	23.0	1.1	1.0	15.5	2.1	2.0
Initial Q Delay(d3),s/veh	0.0	0.0	0.0	0.0	0.0	0.0	0.0	0.0	0.0	0.0	0.0	0.0
%ile BackOfQ(50%),veh/ln	1.3	0.0	0.0	0.9	0.0	0.0	0.5	0.3	0.3	10.2	8.1	8.4
Unsig. Movement Delay, s/veh												
LnGrp Delay(d),s/veh	68.4	0.0	0.0	67.5	0.0	0.0	94.6	1.1	1.0	75.3	7.5	7.4
LnGrp LOS	E	A	A	E	A		F	A	A	E	A	A
Approach Vol, veh/h		34			24			812			2063	
Approach Delay, s/veh		68.4			67.5			2.1			23.5	
Approach LOS		E			E			A			C	
Timer - Assigned Phs	1	2		4	5	6		8				
Phs Duration (G+Y+Rc), s	7.3	128.1		14.6	33.9	101.5		14.6				
Change Period (Y+Rc), s	* 5.7	6.0		* 6.3	* 5.7	6.0		* 6.3				
Max Green Setting (Gmax), s	* 33	69.0		* 30	* 33	69.0		* 30				
Max Q Clear Time (g_c+I1), s	2.8	29.2		4.1	25.1	2.0		5.2				
Green Ext Time (p_c), s	0.0	1.5		0.0	3.1	0.7		0.1				
Intersection Summary												
HCM 6th Ctrl Delay				18.4								
HCM 6th LOS				B								
Notes												
* HCM 6th computational engine requires equal clearance times for the phases crossing the barrier.												
Unsignalized Delay for [NWR] is excluded from calculations of the approach delay and intersection delay.												

Timings

102: Alton Rd & 20 St/Sunset Harbour Dr



Lane Group	EBL	EBT	EBR	WBT	NEL	NET	SWL	SWT	SWR
Lane Configurations									
Traffic Volume (vph)	144	3	15	3	118	587	29	1202	271
Future Volume (vph)	144	3	15	3	118	587	29	1202	271
Turn Type	Split	NA	Perm	NA	pm+pt	NA	Perm	NA	Perm
Protected Phases	3	3		4	1	6		2	
Permitted Phases			3		6		2		2
Detector Phase	3	3	3	4	1	6	2	2	2
Switch Phase									
Minimum Initial (s)	7.0	7.0	7.0	7.0	5.0	7.0	7.0	7.0	7.0
Minimum Split (s)	13.3	13.3	13.3	13.3	11.0	43.3	43.3	43.3	43.3
Total Split (s)	33.0	33.0	33.0	15.0	15.0	102.0	87.0	87.0	87.0
Total Split (%)	22.0%	22.0%	22.0%	10.0%	10.0%	68.0%	58.0%	58.0%	58.0%
Yellow Time (s)	4.0	4.0	4.0	4.0	4.0	4.0	4.0	4.0	4.0
All-Red Time (s)	2.3	2.3	2.3	2.3	2.0	3.3	3.3	3.3	3.3
Lost Time Adjust (s)	-1.3	0.0	-1.3	-1.3	1.0	1.0	-1.5	-1.5	-1.5
Total Lost Time (s)	5.0	6.3	5.0	5.0	7.0	8.3	5.8	5.8	5.8
Lead/Lag	Lead	Lead	Lead	Lag	Lead		Lag	Lag	Lag
Lead-Lag Optimize?	Yes	Yes	Yes	Yes	Yes		Yes	Yes	Yes
Recall Mode	None	None	None	None	None	C-Max	C-Max	C-Max	C-Max
Act Effct Green (s)	14.6	13.3	14.6	8.4	118.0	116.7	103.3	103.3	103.3
Actuated g/C Ratio	0.10	0.09	0.10	0.06	0.79	0.78	0.69	0.69	0.69
v/c Ratio	0.58	0.62	0.07	0.13	0.53	0.28	0.07	0.63	0.31
Control Delay	79.7	85.2	0.5	47.4	12.9	6.1	10.6	18.8	8.9
Queue Delay	0.0	0.0	0.0	0.0	0.0	0.0	0.0	0.9	1.0
Total Delay	79.7	85.2	0.5	47.4	12.9	6.1	10.6	19.7	9.8
LOS	E	F	A	D	B	A	B	B	A
Approach Delay		74.8		47.4		7.2		17.8	
Approach LOS		E		D		A		B	

Intersection Summary

Cycle Length: 150

Actuated Cycle Length: 150

Offset: 23 (15%), Referenced to phase 2:SWTL and 6:NETL, Start of Yellow

Natural Cycle: 85

Control Type: Actuated-Coordinated

Maximum v/c Ratio: 0.63

Intersection Signal Delay: 18.6

Intersection LOS: B

Intersection Capacity Utilization 71.3%

ICU Level of Service C

Analysis Period (min) 15

Splits and Phases: 102: Alton Rd & 20 St/Sunset Harbour Dr

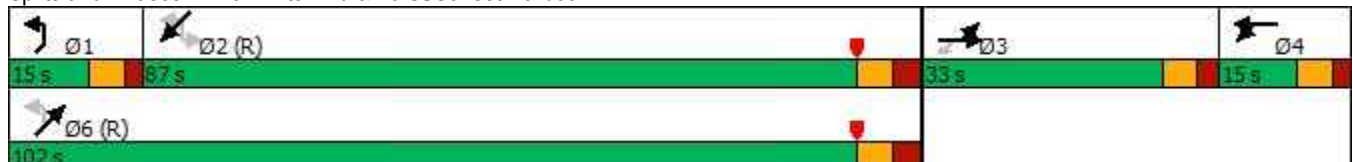

Queues

102: Alton Rd & 20 St/Sunset Harbour Dr



Lane Group	EBL	EBT	EBR	WBT	NEL	NET	SWL	SWT	SWR
Lane Group Flow (vph)	84	83	17	12	134	680	33	1366	308
v/c Ratio	0.58	0.62	0.07	0.13	0.53	0.28	0.07	0.63	0.31
Control Delay	79.7	85.2	0.5	47.4	12.9	6.1	10.6	18.8	8.9
Queue Delay	0.0	0.0	0.0	0.0	0.0	0.0	0.0	0.9	1.0
Total Delay	79.7	85.2	0.5	47.4	12.9	6.1	10.6	19.7	9.8
Queue Length 50th (ft)	84	84	0	5	21	69	11	397	86
Queue Length 95th (ft)	138	137	0	27	64	157	m26	704	207
Internal Link Dist (ft)		175		136		403		268	
Turn Bay Length (ft)					270		110		120
Base Capacity (vph)	279	267	358	107	261	2446	448	2171	983
Starvation Cap Reductn	0	0	0	0	0	0	0	482	431
Spillback Cap Reductn	0	0	0	0	0	162	0	0	0
Storage Cap Reductn	0	0	0	0	0	0	0	0	0
Reduced v/c Ratio	0.30	0.31	0.05	0.11	0.51	0.30	0.07	0.81	0.56

Intersection Summary

m Volume for 95th percentile queue is metered by upstream signal.

HCM Signalized Intersection Capacity Analysis

102: Alton Rd & 20 St/Sunset Harbour Dr



Movement	EBL	EBT	EBR	WBL	WBT	WBR	NEL	NET	NER	SWL	SWT	SWR
Lane Configurations												
Traffic Volume (vph)	144	3	15	2	3	6	118	587	11	29	1202	271
Future Volume (vph)	144	3	15	2	3	6	118	587	11	29	1202	271
Ideal Flow (vphpl)	1900	1900	1900	1900	1900	1900	1900	1900	1900	1900	1900	1900
Total Lost time (s)	5.0	6.3	5.0		5.0		7.0	8.3		5.8	5.8	5.8
Lane Util. Factor	0.95	0.95	1.00		1.00		1.00	0.95		1.00	0.95	1.00
Frpb, ped/bikes	1.00	1.00	0.98		1.00		1.00	1.00		1.00	1.00	0.97
Flpb, ped/bikes	1.00	1.00	1.00		1.00		1.00	1.00		1.00	1.00	1.00
Frt	1.00	1.00	0.85		0.92		1.00	1.00		1.00	1.00	0.85
Flt Protected	0.95	0.95	1.00		0.99		0.95	1.00		0.95	1.00	1.00
Satd. Flow (prot)	1498	1505	1390		1517		1577	3145		1577	3154	1372
Flt Permitted	0.95	0.95	1.00		0.99		0.13	1.00		0.39	1.00	1.00
Satd. Flow (perm)	1498	1505	1390		1517		219	3145		653	3154	1372
Peak-hour factor, PHF	0.88	0.88	0.88	0.88	0.88	0.88	0.88	0.88	0.88	0.88	0.88	0.88
Adj. Flow (vph)	164	3	17	2	3	7	134	667	12	33	1366	308
RTOR Reduction (vph)	0	0	15	0	7	0	0	0	0	0	0	44
Lane Group Flow (vph)	84	83	2	0	5	0	134	680	0	33	1366	264
Confl. Peds. (#/hr)			1	1			1					1
Confl. Bikes (#/hr)												10
Turn Type	Split	NA	Perm	Split	NA		pm+pt	NA		Perm	NA	Perm
Protected Phases	3	3		4	4		1	6			2	
Permitted Phases			3				6			2		2
Actuated Green, G (s)	13.3	13.3	13.3		2.9		113.9	113.9		98.0	98.0	98.0
Effective Green, g (s)	14.6	13.3	14.6		4.2		112.9	112.9		99.5	99.5	99.5
Actuated g/C Ratio	0.10	0.09	0.10		0.03		0.75	0.75		0.66	0.66	0.66
Clearance Time (s)	6.3	6.3	6.3		6.3		6.0	7.3		7.3	7.3	7.3
Vehicle Extension (s)	2.5	2.5	2.5		2.5		2.0	1.0		1.0	1.0	1.0
Lane Grp Cap (vph)	145	133	135		42		245	2367		433	2092	910
v/s Ratio Prot	c0.06	0.06			c0.00		c0.03	0.22			c0.43	
v/s Ratio Perm			0.00				0.38			0.05		0.19
v/c Ratio	0.58	0.62	0.01		0.12		0.55	0.29		0.08	0.65	0.29
Uniform Delay, d1	64.8	65.9	61.2		71.1		11.8	5.9		9.0	15.0	10.5
Progression Factor	1.00	1.00	1.00		1.00		1.00	1.00		0.87	1.12	1.18
Incremental Delay, d2	4.5	7.7	0.0		1.0		1.3	0.3		0.3	1.4	0.7
Delay (s)	69.3	73.6	61.2		72.1		13.1	6.2		8.1	18.2	13.1
Level of Service	E	E	E		E		B	A		A	B	B
Approach Delay (s)		70.5			72.1			7.3			17.1	
Approach LOS		E			E			A			B	
Intersection Summary												
HCM 2000 Control Delay			18.0			HCM 2000 Level of Service			B			
HCM 2000 Volume to Capacity ratio			0.63									
Actuated Cycle Length (s)			150.0			Sum of lost time (s)			24.1			
Intersection Capacity Utilization			71.3%			ICU Level of Service			C			
Analysis Period (min)			15									
c Critical Lane Group												

HCM 6th Signalized Intersection Summary
102: Alton Rd & 20 St/Sunset Harbour Dr

HCM 6th Edition methodology expects strict NEMA phasing.

HCM 6th TWSC
103: Alton Rd & 19 St

Intersection						
Int Delay, s/veh	0.2					
Movement	WBL	WBR	NBT	NBR	SBL	SBT
Lane Configurations		↑	↑↑			↑↑
Traffic Vol, veh/h	0	38	696	23	0	1176
Future Vol, veh/h	0	38	696	23	0	1176
Conflicting Peds, #/hr	0	0	0	0	0	0
Sign Control	Stop	Stop	Free	Free	Free	Free
RT Channelized	-	None	-	None	-	None
Storage Length	-	0	-	-	-	-
Veh in Median Storage, #	0	-	0	-	-	0
Grade, %	0	-	0	-	-	0
Peak Hour Factor	92	92	92	92	92	92
Heavy Vehicles, %	3	3	3	3	3	3
Mvmt Flow	0	41	757	25	0	1278

Major/Minor	Minor1	Major1	Major2		
Conflicting Flow All	-	391	0	0	-
Stage 1	-	-	-	-	-
Stage 2	-	-	-	-	-
Critical Hdwy	-	4.5	-	-	-
Critical Hdwy Stg 1	-	-	-	-	-
Critical Hdwy Stg 2	-	-	-	-	-
Follow-up Hdwy	-	3	-	-	-
Pot Cap-1 Maneuver	0	862	-	-	0
Stage 1	0	-	-	-	0
Stage 2	0	-	-	-	0
Platoon blocked, %			-	-	-
Mov Cap-1 Maneuver	-	862	-	-	-
Mov Cap-2 Maneuver	-	-	-	-	-
Stage 1	-	-	-	-	-
Stage 2	-	-	-	-	-

Approach	WB	NB	SB
HCM Control Delay, s	9.4	0	0
HCM LOS	A		

Minor Lane/Major Mvmt	NBT	NBRWBLn1	SBT
Capacity (veh/h)	-	-	862
HCM Lane V/C Ratio	-	-	0.048
HCM Control Delay (s)	-	-	9.4
HCM Lane LOS	-	-	A
HCM 95th %tile Q(veh)	-	-	0.2

Timings

104: Alton Road & Dade Boulevard



Lane Group	EBL	EBT	WBL	WBT	WBR	NBL	NBT	SBL	SBT	SBR
Lane Configurations										
Traffic Volume (vph)	203	140	141	109	44	70	480	45	994	171
Future Volume (vph)	203	140	141	109	44	70	480	45	994	171
Turn Type	pm+pt	NA	pm+pt	NA	Perm	pm+pt	NA	Prot	NA	pm+ov
Protected Phases	3	8	7	4		1	6	5	2	3
Permitted Phases	8		4		4	6				2
Detector Phase	3	8	7	4	4	1	6	5	2	3
Switch Phase										
Minimum Initial (s)	5.0	7.0	5.0	7.0	7.0	5.0	4.0	5.0	4.0	5.0
Minimum Split (s)	11.0	37.0	11.0	37.0	37.0	11.0	29.0	11.0	29.0	11.0
Total Split (s)	16.0	37.0	20.0	40.0	40.0	17.0	76.0	17.0	76.0	16.0
Total Split (%)	10.7%	24.7%	13.3%	26.7%	26.7%	11.3%	50.7%	11.3%	50.7%	10.7%
Yellow Time (s)	3.7	4.0	3.7	4.0	4.0	3.7	4.0	3.7	4.0	3.7
All-Red Time (s)	2.0	2.0	2.0	2.0	2.0	2.0	2.0	2.0	2.0	2.0
Lost Time Adjust (s)	0.0	0.0	0.0	0.0	0.0	0.0	0.0	0.0	0.0	0.0
Total Lost Time (s)	5.7	6.0	5.7	6.0	6.0	5.7	6.0	5.7	6.0	5.7
Lead/Lag	Lead	Lag	Lead	Lag	Lag	Lead	Lag	Lead	Lag	Lead
Lead-Lag Optimize?	Yes	Yes	Yes	Yes	Yes	Yes	Yes	Yes	Yes	Yes
Recall Mode	None	None	None	None	None	None	C-Max	None	C-Max	None
Act Effct Green (s)	23.2	12.6	29.8	15.9	15.9	99.6	93.4	9.1	93.6	104.2
Actuated g/C Ratio	0.15	0.08	0.20	0.11	0.11	0.66	0.62	0.06	0.62	0.69
v/c Ratio	1.09	0.62	0.68	0.36	0.20	0.27	0.38	0.52	0.56	0.19
Control Delay	142.3	74.7	66.6	64.3	1.9	10.1	15.0	86.2	18.3	5.1
Queue Delay	0.0	0.0	0.0	0.0	0.0	0.0	0.0	0.0	0.0	0.0
Total Delay	142.3	74.7	66.6	64.3	1.9	10.1	15.0	86.2	18.3	5.1
LOS	F	E	E	E	A	B	B	F	B	A
Approach Delay		113.7		56.1			14.5		18.9	
Approach LOS		F		E			B		B	

Intersection Summary

Cycle Length: 150

Actuated Cycle Length: 150

Offset: 25 (17%), Referenced to phase 2:SBT and 6:NBTL, Start of Yellow

Natural Cycle: 90

Control Type: Actuated-Coordinated

Maximum v/c Ratio: 1.09

Intersection Signal Delay: 34.8

Intersection LOS: C

Intersection Capacity Utilization 74.0%

ICU Level of Service D

Analysis Period (min) 15

Splits and Phases: 104: Alton Road & Dade Boulevard

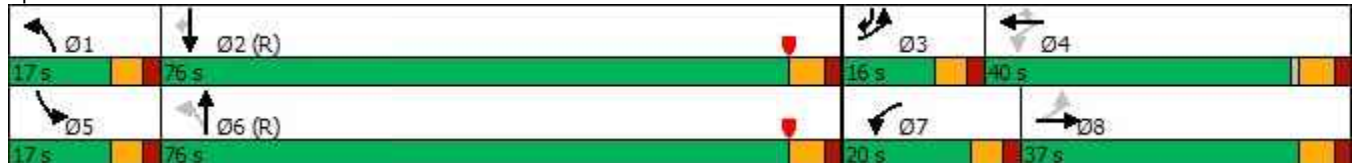

Queues

104: Alton Road & Dade Boulevard



Lane Group	EBL	EBT	WBL	WBT	WBR	NBL	NBT	SBL	SBT	SBR
Lane Group Flow (vph)	223	164	155	120	48	77	720	49	1092	188
v/c Ratio	1.09	0.62	0.68	0.36	0.20	0.27	0.38	0.52	0.56	0.19
Control Delay	142.3	74.7	66.6	64.3	1.9	10.1	15.0	86.2	18.3	5.1
Queue Delay	0.0	0.0	0.0	0.0	0.0	0.0	0.0	0.0	0.0	0.0
Total Delay	142.3	74.7	66.6	64.3	1.9	10.1	15.0	86.2	18.3	5.1
Queue Length 50th (ft)	~222	81	133	57	0	22	171	47	311	33
Queue Length 95th (ft)	#380	118	201	90	0	43	246	92	415	68
Internal Link Dist (ft)		316		456			473		500	
Turn Bay Length (ft)	220		185		60	350		185		70
Base Capacity (vph)	204	647	235	735	400	328	1884	122	1967	973
Starvation Cap Reductn	0	0	0	0	0	0	0	0	0	0
Spillback Cap Reductn	0	0	0	0	0	0	0	0	0	0
Storage Cap Reductn	0	0	0	0	0	0	0	0	0	0
Reduced v/c Ratio	1.09	0.25	0.66	0.16	0.12	0.23	0.38	0.40	0.56	0.19

Intersection Summary

~ Volume exceeds capacity, queue is theoretically infinite.























Queue shown is maximum after two cycles.

95th percentile volume exceeds capacity, queue may be longer.

Queue shown is maximum after two cycles.

HCM 6th Signalized Intersection Summary

104: Alton Road & Dade Boulevard

												
Movement	EBL	EBT	EBR	WBL	WBT	WBR	NBL	NBT	NBR	SBL	SBT	SBR
Lane Configurations												
Traffic Volume (veh/h)	203	140	9	141	109	44	70	480	176	45	994	171
Future Volume (veh/h)	203	140	9	141	109	44	70	480	176	45	994	171
Initial Q (Qb), veh	0	0	0	0	0	0	0	0	0	0	0	0
Ped-Bike Adj(A_pbT)	0.98		1.00	0.99		1.00	1.00		0.98	1.00		0.98
Parking Bus, Adj	1.00	1.00	1.00	1.00	1.00	1.00	1.00	1.00	1.00	1.00	1.00	1.00
Work Zone On Approach		No			No			No			No	
Adj Sat Flow, veh/h/ln	1670	1670	1670	1670	1670	1670	1670	1670	1670	1670	1670	1670
Adj Flow Rate, veh/h	223	154	0	155	120	0	77	527	193	49	1092	188
Peak Hour Factor	0.91	0.91	0.91	0.91	0.91	0.91	0.91	0.91	0.91	0.91	0.91	0.91
Percent Heavy Veh, %	3	3	3	3	3	3	3	3	3	3	3	3
Cap, veh/h	256	305		254	390		261	1390	507	61	1969	957
Arrive On Green	0.07	0.10	0.00	0.10	0.12	0.00	0.03	0.61	0.61	0.04	0.62	0.62
Sat Flow, veh/h	1590	3256	0	1590	3173	1415	1590	2263	825	1590	3173	1385
Grp Volume(v), veh/h	223	154	0	155	120	0	77	369	351	49	1092	188
Grp Sat Flow(s),veh/h/ln	1590	1586	0	1590	1586	1415	1590	1586	1502	1590	1586	1385
Q Serve(g_s), s	10.3	6.9	0.0	13.1	5.2	0.0	2.7	17.5	17.7	4.6	29.9	7.3
Cycle Q Clear(g_c), s	10.3	6.9	0.0	13.1	5.2	0.0	2.7	17.5	17.7	4.6	29.9	7.3
Prop In Lane	1.00		0.00	1.00		1.00	1.00		0.55	1.00		1.00
Lane Grp Cap(c), veh/h	256	305		254	390		261	974	922	61	1969	957
V/C Ratio(X)	0.87	0.50		0.61	0.31		0.29	0.38	0.38	0.80	0.55	0.20
Avail Cap(c_a), veh/h	256	656		254	719		330	974	922	120	1969	957
HCM Platoon Ratio	1.00	1.00	1.00	1.00	1.00	1.00	1.00	1.00	1.00	1.00	1.00	1.00
Upstream Filter(I)	1.00	1.00	0.00	1.00	1.00	0.00	1.00	1.00	1.00	1.00	1.00	1.00
Uniform Delay (d), s/veh	62.5	64.4	0.0	54.2	60.0	0.0	13.4	14.5	14.6	71.6	16.5	8.4
Incr Delay (d2), s/veh	25.2	1.0	0.0	3.1	0.3	0.0	0.2	1.1	1.2	8.9	1.1	0.5
Initial Q Delay(d3),s/veh	0.0	0.0	0.0	0.0	0.0	0.0	0.0	0.0	0.0	0.0	0.0	0.0
%ile BackOfQ(50%),veh/ln	5.9	2.9	0.0	5.5	2.1	0.0	1.0	6.6	6.4	2.0	11.1	2.3
Unsig. Movement Delay, s/veh												
LnGrp Delay(d),s/veh	87.6	65.3	0.0	57.3	60.3	0.0	13.6	15.7	15.8	80.5	17.6	8.8
LnGrp LOS	F	E		E	E		B	B	B	F	B	A
Approach Vol, veh/h		377			275			797			1329	
Approach Delay, s/veh		78.5			58.6			15.5			18.7	
Approach LOS		E			E			B			B	
Timer - Assigned Phs	1	2	3	4	5	6	7	8				
Phs Duration (G+Y+Rc), s	10.5	99.1	16.0	24.4	11.4	98.1	20.0	20.4				
Change Period (Y+Rc), s	* 5.7	6.0	* 5.7	6.0	* 5.7	6.0	* 5.7	6.0				
Max Green Setting (Gmax), s	* 11	70.0	* 10	34.0	* 11	70.0	* 14	31.0				
Max Q Clear Time (g_c+I1), s	4.7	31.9	12.3	7.2	6.6	19.7	15.1	8.9				
Green Ext Time (p_c), s	0.0	3.5	0.0	0.6	0.0	1.7	0.0	0.7				
Intersection Summary												
HCM 6th Ctrl Delay				29.8								
HCM 6th LOS				C								
Notes												
* HCM 6th computational engine requires equal clearance times for the phases crossing the barrier.												
Unsignalized Delay for [EBR, WBR] is excluded from calculations of the approach delay and intersection delay.												

Timings

105: Dade Blvd & Michigan Ave



Lane Group	EBT	WBT	WBR	SEL	SER	Ø3
Lane Configurations	↑↑	↑↑	↑	↑↑	↑	
Traffic Volume (vph)	330	271	281	471	19	
Future Volume (vph)	330	271	281	471	19	
Turn Type	NA	NA	pm+ov	Prot	Perm	
Protected Phases	6	2	4	4		3
Permitted Phases			2		4	
Detector Phase	6	2	4	4	4	
Switch Phase						
Minimum Initial (s)	14.0	14.0	7.0	7.0	7.0	1.0
Minimum Split (s)	36.0	36.0	20.6	20.6	20.6	27.0
Total Split (s)	39.0	39.0	54.0	54.0	54.0	27.0
Total Split (%)	32.5%	32.5%	45.0%	45.0%	45.0%	23%
Yellow Time (s)	4.0	4.0	4.0	4.0	4.0	2.0
All-Red Time (s)	2.0	2.0	2.0	2.0	2.0	0.0
Lost Time Adjust (s)	0.0	0.0	0.0	0.0	0.0	
Total Lost Time (s)	6.0	6.0	6.0	6.0	6.0	
Lead/Lag			Lag	Lag	Lag	Lead
Lead-Lag Optimize?			Yes	Yes	Yes	Yes
Recall Mode	C-Max	C-Max	None	None	None	None
Act Effect Green (s)	79.9	79.9	120.0	28.1	28.1	
Actuated g/C Ratio	0.67	0.67	1.00	0.23	0.23	
v/c Ratio	0.17	0.14	0.22	0.72	0.06	
Control Delay	8.4	8.3	0.3	47.4	12.2	
Queue Delay	0.0	0.0	0.0	0.0	0.0	
Total Delay	8.4	8.3	0.3	47.4	12.2	
LOS	A	A	A	D	B	
Approach Delay	8.4	4.2		46.0		
Approach LOS	A	A		D		

Intersection Summary

Cycle Length: 120
 Actuated Cycle Length: 120
 Offset: 117 (98%), Referenced to phase 2:WBT and 6:EBT, Start of Yellow
 Natural Cycle: 85
 Control Type: Actuated-Coordinated
 Maximum v/c Ratio: 0.72
 Intersection Signal Delay: 20.2
 Intersection Capacity Utilization 35.1%
 Analysis Period (min) 15

Intersection LOS: C
 ICU Level of Service A

Splits and Phases: 105: Dade Blvd & Michigan Ave

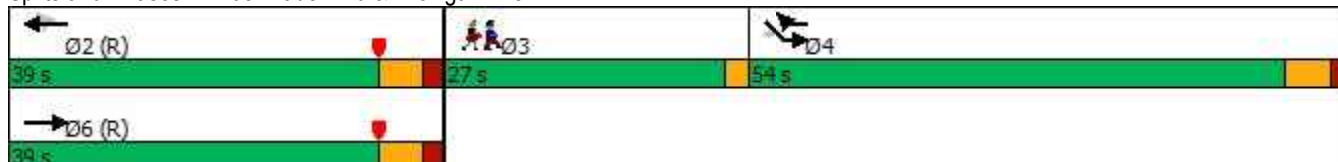

Queues

105: Dade Blvd & Michigan Ave



Lane Group	EBT	WBT	WBR	SEL	SER
Lane Group Flow (vph)	402	330	343	574	23
v/c Ratio	0.17	0.14	0.22	0.72	0.06
Control Delay	8.4	8.3	0.3	47.4	12.2
Queue Delay	0.0	0.0	0.0	0.0	0.0
Total Delay	8.4	8.3	0.3	47.4	12.2
Queue Length 50th (ft)	56	45	0	212	0
Queue Length 95th (ft)	84	69	0	224	17
Internal Link Dist (ft)	166	341		11	
Turn Bay Length (ft)			280		
Base Capacity (vph)	2334	2334	1568	1360	641
Starvation Cap Reductn	0	0	0	0	0
Spillback Cap Reductn	0	0	0	0	0
Storage Cap Reductn	0	0	0	0	0
Reduced v/c Ratio	0.17	0.14	0.22	0.42	0.04

Intersection Summary

HCM Signalized Intersection Capacity Analysis

105: Dade Blvd & Michigan Ave



Movement	EBL	EBT	WBT	WBR	SEL	SER
Lane Configurations		↑↑	↑↑	↑	↑↑	↑
Traffic Volume (vph)	0	330	271	281	471	19
Future Volume (vph)	0	330	271	281	471	19
Ideal Flow (vphpl)	1900	1900	1900	1900	1900	1900
Total Lost time (s)		6.0	6.0	6.0	6.0	6.0
Lane Util. Factor		0.95	0.95	1.00	0.97	1.00
Frbp, ped/bikes		1.00	1.00	1.00	1.00	1.00
Flpb, ped/bikes		1.00	1.00	1.00	1.00	1.00
Frt		1.00	1.00	0.85	1.00	0.85
Flt Protected		1.00	1.00	1.00	0.95	1.00
Satd. Flow (prot)		3505	3505	1568	3400	1568
Flt Permitted		1.00	1.00	1.00	0.95	1.00
Satd. Flow (perm)		3505	3505	1568	3400	1568
Peak-hour factor, PHF	0.82	0.82	0.82	0.82	0.82	0.82
Adj. Flow (vph)	0	402	330	343	574	23
RTOR Reduction (vph)	0	0	0	34	0	18
Lane Group Flow (vph)	0	402	330	309	574	5
Confl. Peds. (#/hr)	4					
Turn Type		NA	NA	pm+ov	Prot	Perm
Protected Phases		6	2	4	4	
Permitted Phases				2		4
Actuated Green, G (s)		79.9	79.9	108.0	28.1	28.1
Effective Green, g (s)		79.9	79.9	108.0	28.1	28.1
Actuated g/C Ratio		0.67	0.67	0.90	0.23	0.23
Clearance Time (s)		6.0	6.0	6.0	6.0	6.0
Vehicle Extension (s)		1.0	1.0	3.5	3.5	3.5
Lane Grp Cap (vph)		2333	2333	1568	796	367
v/s Ratio Prot		0.11	0.09	c0.05	c0.17	
v/s Ratio Perm				0.15		0.00
v/c Ratio		0.17	0.14	0.20	0.72	0.01
Uniform Delay, d1		7.6	7.4	0.7	42.3	35.3
Progression Factor		1.00	1.00	1.00	1.00	1.00
Incremental Delay, d2		0.2	0.1	0.1	3.3	0.0
Delay (s)		7.7	7.5	0.8	45.7	35.3
Level of Service		A	A	A	D	D
Approach Delay (s)		7.7	4.1		45.3	
Approach LOS		A	A		D	
Intersection Summary						
HCM 2000 Control Delay			19.7		HCM 2000 Level of Service	B
HCM 2000 Volume to Capacity ratio			0.35			
Actuated Cycle Length (s)			120.0		Sum of lost time (s)	14.0
Intersection Capacity Utilization			35.1%		ICU Level of Service	A
Analysis Period (min)			15			
c Critical Lane Group						

HCM 6th Signalized Intersection Summary
105: Dade Blvd & Michigan Ave

HCM 6th Edition methodology does not support exclusive ped or hold phases.

Timings

101: Alton Rd & N Michigan Ave



Lane Group	SEL	SET	NWL	NWT	NWR	NEL	NET	SWL	SWT
Lane Configurations		↔		↔	↔	↔	↔	↔	↔
Traffic Volume (vph)	15	10	19	3	250	9	707	454	1428
Future Volume (vph)	15	10	19	3	250	9	707	454	1428
Turn Type	Perm	NA	Perm	NA	Free	Prot	NA	Prot	NA
Protected Phases		8		4		1	6	5	2
Permitted Phases	8		4		Free				
Detector Phase	8	8	4	4		1	6	5	2
Switch Phase									
Minimum Initial (s)	7.0	7.0	7.0	7.0		5.0	14.0	5.0	14.0
Minimum Split (s)	36.3	36.3	36.3	36.3		10.7	27.0	10.7	27.0
Total Split (s)	36.3	36.3	36.3	36.3		38.7	75.0	38.7	75.0
Total Split (%)	24.2%	24.2%	24.2%	24.2%		25.8%	50.0%	25.8%	50.0%
Yellow Time (s)	4.0	4.0	4.0	4.0		3.7	4.0	3.7	4.0
All-Red Time (s)	2.3	2.3	2.3	2.3		2.0	2.0	2.0	2.0
Lost Time Adjust (s)		-1.0		-1.0		-1.0	-1.0	1.0	1.0
Total Lost Time (s)		5.3		5.3		4.7	5.0	6.7	7.0
Lead/Lag						Lead	Lag	Lead	Lag
Lead-Lag Optimize?						Yes	Yes	Yes	Yes
Recall Mode	None	None	None	None		None	C-Max	None	C-Max
Act Effct Green (s)		9.5		9.5	150.0	10.6	94.3	31.9	125.7
Actuated g/C Ratio		0.06		0.06	1.00	0.07	0.63	0.21	0.84
v/c Ratio		0.38		0.27	0.19	0.09	0.40	0.76	0.60
Control Delay		66.0		74.0	0.3	79.9	16.1	63.1	7.5
Queue Delay		0.0		0.0	0.0	0.0	0.4	0.0	0.5
Total Delay		66.0		74.0	0.3	79.9	16.5	63.1	8.0
LOS		E		E	A	E	B	E	A
Approach Delay		66.0		6.3			17.3		21.1
Approach LOS		E		A			B		C

Intersection Summary

Cycle Length: 150

Actuated Cycle Length: 150

Offset: 6 (4%), Referenced to phase 2:SWT and 6:NET, Start of Yellow

Natural Cycle: 100

Control Type: Actuated-Coordinated

Maximum v/c Ratio: 0.76

Intersection Signal Delay: 19.3

Intersection LOS: B

Intersection Capacity Utilization 72.7%

ICU Level of Service C

Analysis Period (min) 15

Splits and Phases: 101: Alton Rd & N Michigan Ave

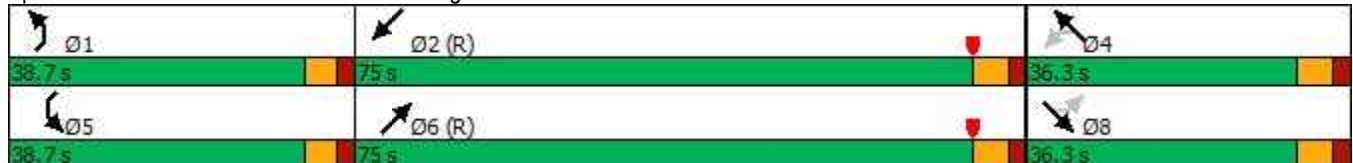

Queues

101: Alton Rd & N Michigan Ave





















Lane Group	SET	NWT	NWR	NEL	NET	SWL	SWT
Lane Group Flow (vph)	35	24	272	10	806	493	1575
v/c Ratio	0.38	0.27	0.19	0.09	0.40	0.76	0.60
Control Delay	66.0	74.0	0.3	79.9	16.1	63.1	7.5
Queue Delay	0.0	0.0	0.0	0.0	0.4	0.0	0.5
Total Delay	66.0	74.0	0.3	79.9	16.5	63.1	8.0
Queue Length 50th (ft)	26	23	0	10	263	235	174
Queue Length 95th (ft)	64	54	0	m30	355	282	487
Internal Link Dist (ft)	247	552			268		227
Turn Bay Length (ft)				100		265	
Base Capacity (vph)	285	286	1411	357	2001	694	2637
Starvation Cap Reductn	0	0	0	0	665	0	0
Spillback Cap Reductn	0	0	0	0	0	0	543
Storage Cap Reductn	0	0	0	0	0	0	0
Reduced v/c Ratio	0.12	0.08	0.19	0.03	0.60	0.71	0.75

Intersection Summary

m Volume for 95th percentile queue is metered by upstream signal.

HCM 6th Signalized Intersection Summary

101: Alton Rd & N Michigan Ave

												
Movement	SEL	SET	SER	NWL	NWT	NWR	NEL	NET	NER	SWL	SWT	SWR
Lane Configurations												
Traffic Volume (veh/h)	15	10	7	19	3	250	9	707	35	454	1428	21
Future Volume (veh/h)	15	10	7	19	3	250	9	707	35	454	1428	21
Initial Q (Qb), veh	0	0	0	0	0	0	0	0	0	0	0	0
Ped-Bike Adj(A_pbT)	0.99		0.97	0.99		1.00	1.00		0.99	1.00		0.97
Parking Bus, Adj	1.00	1.00	1.00	1.00	1.00	1.00	1.00	1.00	1.00	1.00	1.00	1.00
Work Zone On Approach		No			No			No			No	
Adj Sat Flow, veh/h/ln	1670	1670	1670	1670	1670	1670	1670	1670	1670	1670	1670	1670
Adj Flow Rate, veh/h	16	11	8	21	3	0	10	768	38	493	1552	23
Peak Hour Factor	0.92	0.92	0.92	0.92	0.92	0.92	0.92	0.92	0.92	0.92	0.92	0.92
Percent Heavy Veh, %	3	3	3	3	3	3	3	3	3	3	3	3
Cap, veh/h	65	39	20	118	14		29	1974	98	563	2580	38
Arrive On Green	0.06	0.06	0.06	0.06	0.06	0.00	0.04	1.00	1.00	0.18	0.81	0.81
Sat Flow, veh/h	483	626	329	1171	218	1415	1590	3075	152	3086	3199	47
Grp Volume(v), veh/h	35	0	0	24	0	0	10	396	410	493	769	806
Grp Sat Flow(s),veh/h/ln	1437	0	0	1390	0	1415	1590	1586	1640	1543	1586	1660
Q Serve(g_s), s	1.1	0.0	0.0	0.0	0.0	0.0	0.9	0.0	0.0	23.3	27.3	27.4
Cycle Q Clear(g_c), s	3.3	0.0	0.0	2.1	0.0	0.0	0.9	0.0	0.0	23.3	27.3	27.4
Prop In Lane	0.46		0.23	0.87		1.00	1.00		0.09	1.00		0.03
Lane Grp Cap(c), veh/h	124	0	0	131	0		29	1019	1053	563	1279	1339
V/C Ratio(X)	0.28	0.00	0.00	0.18	0.00		0.35	0.39	0.39	0.88	0.60	0.60
Avail Cap(c_a), veh/h	325	0	0	316	0		361	1019	1053	658	1279	1339
HCM Platoon Ratio	1.00	1.00	1.00	1.00	1.00	1.00	2.00	2.00	2.00	1.00	1.00	1.00
Upstream Filter(I)	1.00	0.00	0.00	1.00	0.00	0.00	0.96	0.96	0.96	1.00	1.00	1.00
Uniform Delay (d), s/veh	67.6	0.0	0.0	67.0	0.0	0.0	71.4	0.0	0.0	59.7	5.4	5.5
Incr Delay (d2), s/veh	0.9	0.0	0.0	0.5	0.0	0.0	23.5	1.1	1.0	15.7	2.1	2.0
Initial Q Delay(d3),s/veh	0.0	0.0	0.0	0.0	0.0	0.0	0.0	0.0	0.0	0.0	0.0	0.0
%ile BackOfQ(50%),veh/ln	1.3	0.0	0.0	0.9	0.0	0.0	0.6	0.3	0.3	10.3	8.2	8.5
Unsig. Movement Delay, s/veh												
LnGrp Delay(d),s/veh	68.5	0.0	0.0	67.5	0.0	0.0	94.9	1.1	1.0	75.4	7.5	7.5
LnGrp LOS	E	A	A	E	A		F	A	A	E	A	A
Approach Vol, veh/h		35			24			816			2068	
Approach Delay, s/veh		68.5			67.5			2.2			23.7	
Approach LOS		E			E			A			C	
Timer - Assigned Phs	1	2		4	5	6		8				
Phs Duration (G+Y+Rc), s	7.4	128.0		14.6	34.1	101.3		14.6				
Change Period (Y+Rc), s	* 5.7	6.0		* 6.3	* 5.7	6.0		* 6.3				
Max Green Setting (Gmax), s	* 33	69.0		* 30	* 33	69.0		* 30				
Max Q Clear Time (g_c+I1), s	2.9	29.4		4.1	25.3	2.0		5.3				
Green Ext Time (p_c), s	0.0	1.5		0.0	3.0	0.7		0.1				

Intersection Summary

HCM 6th Ctrl Delay	18.6
HCM 6th LOS	B

Notes

* HCM 6th computational engine requires equal clearance times for the phases crossing the barrier.

Unsignalized Delay for [NWR] is excluded from calculations of the approach delay and intersection delay.

Timings

102: Alton Rd & 20 St/Sunset Harbour Dr



Lane Group	EBL	EBT	EBR	WBT	NEL	NET	SWL	SWT	SWR
Lane Configurations									
Traffic Volume (vph)	145	3	15	3	119	590	29	1202	271
Future Volume (vph)	145	3	15	3	119	590	29	1202	271
Turn Type	Split	NA	Perm	NA	pm+pt	NA	Perm	NA	Perm
Protected Phases	3	3		4	1	6		2	
Permitted Phases			3		6		2		2
Detector Phase	3	3	3	4	1	6	2	2	2
Switch Phase									
Minimum Initial (s)	7.0	7.0	7.0	7.0	5.0	7.0	7.0	7.0	7.0
Minimum Split (s)	13.3	13.3	13.3	13.3	11.0	43.3	43.3	43.3	43.3
Total Split (s)	33.0	33.0	33.0	15.0	15.0	102.0	87.0	87.0	87.0
Total Split (%)	22.0%	22.0%	22.0%	10.0%	10.0%	68.0%	58.0%	58.0%	58.0%
Yellow Time (s)	4.0	4.0	4.0	4.0	4.0	4.0	4.0	4.0	4.0
All-Red Time (s)	2.3	2.3	2.3	2.3	2.0	3.3	3.3	3.3	3.3
Lost Time Adjust (s)	-1.3	0.0	-1.3	-1.3	1.0	1.0	-1.5	-1.5	-1.5
Total Lost Time (s)	5.0	6.3	5.0	5.0	7.0	8.3	5.8	5.8	5.8
Lead/Lag	Lead	Lead	Lead	Lag	Lead		Lag	Lag	Lag
Lead-Lag Optimize?	Yes	Yes	Yes	Yes	Yes		Yes	Yes	Yes
Recall Mode	None	None	None	None	None	C-Max	C-Max	C-Max	C-Max
Act Effct Green (s)	14.6	13.3	14.6	8.4	118.0	116.7	103.2	103.2	103.2
Actuated g/C Ratio	0.10	0.09	0.10	0.06	0.79	0.78	0.69	0.69	0.69
v/c Ratio	0.58	0.63	0.07	0.13	0.53	0.28	0.07	0.63	0.31
Control Delay	79.7	85.8	0.5	47.4	12.9	6.1	8.8	17.5	7.8
Queue Delay	0.0	0.0	0.0	0.0	0.0	0.0	0.0	0.9	1.0
Total Delay	79.7	85.8	0.5	47.4	12.9	6.1	8.8	18.4	8.8
LOS	E	F	A	D	B	A	A	B	A
Approach Delay		75.2		47.4		7.2		16.5	
Approach LOS		E		D		A		B	

Intersection Summary

Cycle Length: 150

Actuated Cycle Length: 150

Offset: 23 (15%), Referenced to phase 2:SWTL and 6:NETL, Start of Yellow

Natural Cycle: 85

Control Type: Actuated-Coordinated

Maximum v/c Ratio: 0.63

Intersection Signal Delay: 17.8

Intersection LOS: B

Intersection Capacity Utilization 71.4%

ICU Level of Service C

Analysis Period (min) 15

Splits and Phases: 102: Alton Rd & 20 St/Sunset Harbour Dr

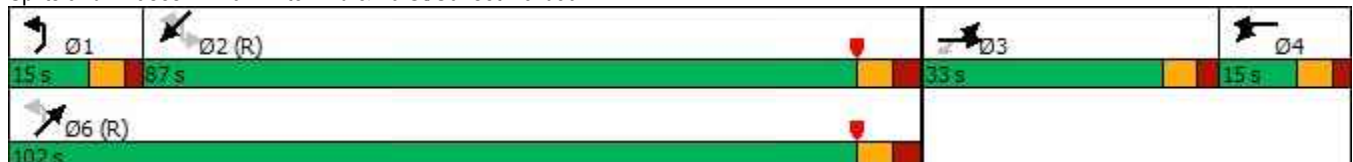

Queues

102: Alton Rd & 20 St/Sunset Harbour Dr



Lane Group	EBL	EBT	EBR	WBT	NEL	NET	SWL	SWT	SWR
Lane Group Flow (vph)	84	84	17	12	135	683	33	1366	308
v/c Ratio	0.58	0.63	0.07	0.13	0.53	0.28	0.07	0.63	0.31
Control Delay	79.7	85.8	0.5	47.4	12.9	6.1	8.8	17.5	7.8
Queue Delay	0.0	0.0	0.0	0.0	0.0	0.0	0.0	0.9	1.0
Total Delay	79.7	85.8	0.5	47.4	12.9	6.1	8.8	18.4	8.8
Queue Length 50th (ft)	84	85	0	5	21	69	11	400	86
Queue Length 95th (ft)	138	140	0	27	65	158	m24	705	206
Internal Link Dist (ft)		175		136		403		268	
Turn Bay Length (ft)					270		110		120
Base Capacity (vph)	279	267	358	107	261	2446	447	2169	982
Starvation Cap Reductn	0	0	0	0	0	0	0	481	431
Spillback Cap Reductn	0	0	0	0	0	175	0	0	0
Storage Cap Reductn	0	0	0	0	0	0	0	0	0
Reduced v/c Ratio	0.30	0.31	0.05	0.11	0.52	0.30	0.07	0.81	0.56

Intersection Summary

m Volume for 95th percentile queue is metered by upstream signal.

HCM Signalized Intersection Capacity Analysis

102: Alton Rd & 20 St/Sunset Harbour Dr



Movement	EBL	EBT	EBR	WBL	WBT	WBR	NEL	NET	NER	SWL	SWT	SWR
Lane Configurations												
Traffic Volume (vph)	145	3	15	2	3	6	119	590	11	29	1202	271
Future Volume (vph)	145	3	15	2	3	6	119	590	11	29	1202	271
Ideal Flow (vphpl)	1900	1900	1900	1900	1900	1900	1900	1900	1900	1900	1900	1900
Total Lost time (s)	5.0	6.3	5.0		5.0		7.0	8.3		5.8	5.8	5.8
Lane Util. Factor	0.95	0.95	1.00		1.00		1.00	0.95		1.00	0.95	1.00
Frpb, ped/bikes	1.00	1.00	0.98		1.00		1.00	1.00		1.00	1.00	0.97
Flpb, ped/bikes	1.00	1.00	1.00		1.00		1.00	1.00		1.00	1.00	1.00
Frt	1.00	1.00	0.85		0.92		1.00	1.00		1.00	1.00	0.85
Flt Protected	0.95	0.95	1.00		0.99		0.95	1.00		0.95	1.00	1.00
Satd. Flow (prot)	1498	1505	1390		1517		1577	3145		1577	3154	1372
Flt Permitted	0.95	0.95	1.00		0.99		0.13	1.00		0.39	1.00	1.00
Satd. Flow (perm)	1498	1505	1390		1517		219	3145		651	3154	1372
Peak-hour factor, PHF	0.88	0.88	0.88	0.88	0.88	0.88	0.88	0.88	0.88	0.88	0.88	0.88
Adj. Flow (vph)	165	3	17	2	3	7	135	670	12	33	1366	308
RTOR Reduction (vph)	0	0	15	0	7	0	0	0	0	0	0	44
Lane Group Flow (vph)	84	84	2	0	5	0	135	683	0	33	1366	264
Confl. Peds. (#/hr)			1	1			1					1
Confl. Bikes (#/hr)												10
Turn Type	Split	NA	Perm	Split	NA		pm+pt	NA		Perm	NA	Perm
Protected Phases	3	3		4	4		1	6			2	
Permitted Phases			3				6			2		2
Actuated Green, G (s)	13.3	13.3	13.3		2.9		113.9	113.9		97.9	97.9	97.9
Effective Green, g (s)	14.6	13.3	14.6		4.2		112.9	112.9		99.4	99.4	99.4
Actuated g/C Ratio	0.10	0.09	0.10		0.03		0.75	0.75		0.66	0.66	0.66
Clearance Time (s)	6.3	6.3	6.3		6.3		6.0	7.3		7.3	7.3	7.3
Vehicle Extension (s)	2.5	2.5	2.5		2.5		2.0	1.0		1.0	1.0	1.0
Lane Grp Cap (vph)	145	133	135		42		246	2367		431	2090	909
v/s Ratio Prot	c0.06	0.06			c0.00		c0.03	0.22			c0.43	
v/s Ratio Perm			0.00				0.38			0.05		0.19
v/c Ratio	0.58	0.63	0.01		0.12		0.55	0.29		0.08	0.65	0.29
Uniform Delay, d1	64.8	66.0	61.2		71.1		11.9	5.9		9.0	15.1	10.6
Progression Factor	1.00	1.00	1.00		1.00		1.00	1.00		0.72	1.04	1.03
Incremental Delay, d2	4.5	8.3	0.0		1.0		1.3	0.3		0.3	1.4	0.7
Delay (s)	69.3	74.2	61.2		72.1		13.2	6.2		6.7	17.0	11.5
Level of Service	E	E	E		E		B	A		A	B	B
Approach Delay (s)		70.8			72.1			7.3			15.8	
Approach LOS		E			E			A			B	
Intersection Summary												
HCM 2000 Control Delay			17.2				HCM 2000 Level of Service			B		
HCM 2000 Volume to Capacity ratio			0.63									
Actuated Cycle Length (s)			150.0				Sum of lost time (s)			24.1		
Intersection Capacity Utilization			71.4%				ICU Level of Service			C		
Analysis Period (min)			15									
c Critical Lane Group												

HCM 6th Signalized Intersection Summary
102: Alton Rd & 20 St/Sunset Harbour Dr

HCM 6th Edition methodology expects strict NEMA phasing.

HCM 6th TWSC
103: Alton Rd & 19 St

Intersection						
Int Delay, s/veh	0.2					
Movement	WBL	WBR	NBT	NBR	SBL	SBT
Lane Configurations		↗	↕			↕
Traffic Vol, veh/h	0	42	696	38	0	1176
Future Vol, veh/h	0	42	696	38	0	1176
Conflicting Peds, #/hr	0	0	0	0	0	0
Sign Control	Stop	Stop	Free	Free	Free	Free
RT Channelized	-	None	-	None	-	None
Storage Length	-	0	-	-	-	-
Veh in Median Storage, #	0	-	0	-	-	0
Grade, %	0	-	0	-	-	0
Peak Hour Factor	92	92	92	92	92	92
Heavy Vehicles, %	3	3	3	3	3	3
Mvmt Flow	0	46	757	41	0	1278

Major/Minor	Minor1	Major1	Major2		
Conflicting Flow All	-	399	0	0	-
Stage 1	-	-	-	-	-
Stage 2	-	-	-	-	-
Critical Hdwy	-	4.5	-	-	-
Critical Hdwy Stg 1	-	-	-	-	-
Critical Hdwy Stg 2	-	-	-	-	-
Follow-up Hdwy	-	3	-	-	-
Pot Cap-1 Maneuver	0	857	-	-	0
Stage 1	0	-	-	-	0
Stage 2	0	-	-	-	0
Platoon blocked, %			-	-	-
Mov Cap-1 Maneuver	-	857	-	-	-
Mov Cap-2 Maneuver	-	-	-	-	-
Stage 1	-	-	-	-	-
Stage 2	-	-	-	-	-

Approach	WB	NB	SB
HCM Control Delay, s	9.4	0	0
HCM LOS	A		

Minor Lane/Major Mvmt	NBT	NBRWBLn1	SBT
Capacity (veh/h)	-	-	857
HCM Lane V/C Ratio	-	-	0.053
HCM Control Delay (s)	-	-	9.4
HCM Lane LOS	-	-	A
HCM 95th %tile Q(veh)	-	-	0.2

Timings

104: Alton Road & Dade Boulevard

Lane Group	EBL	EBT	WBL	WBT	WBR	NBL	NBT	SBL	SBT	SBR
Lane Configurations										
Traffic Volume (vph)	208	140	144	112	48	70	486	45	994	171
Future Volume (vph)	208	140	144	112	48	70	486	45	994	171
Turn Type	pm+pt	NA	pm+pt	NA	Perm	pm+pt	NA	Prot	NA	pm+ov
Protected Phases	3	8	7	4		1	6	5	2	3
Permitted Phases	8		4		4	6				2
Detector Phase	3	8	7	4	4	1	6	5	2	3
Switch Phase										
Minimum Initial (s)	5.0	7.0	5.0	7.0	7.0	5.0	4.0	5.0	4.0	5.0
Minimum Split (s)	11.0	37.0	11.0	37.0	37.0	11.0	29.0	11.0	29.0	11.0
Total Split (s)	16.0	37.0	20.0	40.0	40.0	17.0	76.0	17.0	76.0	16.0
Total Split (%)	10.7%	24.7%	13.3%	26.7%	26.7%	11.3%	50.7%	11.3%	50.7%	10.7%
Yellow Time (s)	3.7	4.0	3.7	4.0	4.0	3.7	4.0	3.7	4.0	3.7
All-Red Time (s)	2.0	2.0	2.0	2.0	2.0	2.0	2.0	2.0	2.0	2.0
Lost Time Adjust (s)	0.0	0.0	0.0	0.0	0.0	0.0	0.0	0.0	0.0	0.0
Total Lost Time (s)	5.7	6.0	5.7	6.0	6.0	5.7	6.0	5.7	6.0	5.7
Lead/Lag	Lead	Lag	Lead	Lag	Lag	Lead	Lag	Lead	Lag	Lead
Lead-Lag Optimize?	Yes	Yes	Yes	Yes	Yes	Yes	Yes	Yes	Yes	Yes
Recall Mode	None	None	None	None	None	None	C-Max	None	C-Max	None
Act Effct Green (s)	23.2	12.6	29.9	16.0	16.0	99.5	93.4	9.1	93.5	104.1
Actuated g/C Ratio	0.15	0.08	0.20	0.11	0.11	0.66	0.62	0.06	0.62	0.69
v/c Ratio	1.12	0.62	0.69	0.37	0.22	0.27	0.39	0.52	0.56	0.19
Control Delay	151.2	74.7	67.6	64.5	2.1	10.1	15.1	86.2	18.3	5.1
Queue Delay	0.0	0.0	0.0	0.0	0.0	0.0	0.0	0.0	0.0	0.0
Total Delay	151.2	74.7	67.6	64.5	2.1	10.1	15.1	86.2	18.3	5.1
LOS	F	E	E	E	A	B	B	F	B	A
Approach Delay		119.2		56.0			14.6		18.9	
Approach LOS		F		E			B		B	

Intersection Summary

Cycle Length: 150

Actuated Cycle Length: 150

Offset: 25 (17%), Referenced to phase 2:SBT and 6:NBTL, Start of Yellow

Natural Cycle: 90

Control Type: Actuated-Coordinated

Maximum v/c Ratio: 1.12

Intersection Signal Delay: 35.8

Intersection LOS: D

Intersection Capacity Utilization 74.3%

ICU Level of Service D

Analysis Period (min) 15

Splits and Phases: 104: Alton Road & Dade Boulevard

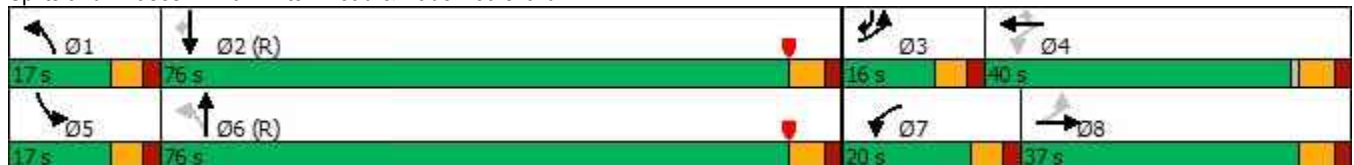

Queues

104: Alton Road & Dade Boulevard



Lane Group	EBL	EBT	WBL	WBT	WBR	NBL	NBT	SBL	SBT	SBR
Lane Group Flow (vph)	229	164	158	123	53	77	727	49	1092	188
v/c Ratio	1.12	0.62	0.69	0.37	0.22	0.27	0.39	0.52	0.56	0.19
Control Delay	151.2	74.7	67.6	64.5	2.1	10.1	15.1	86.2	18.3	5.1
Queue Delay	0.0	0.0	0.0	0.0	0.0	0.0	0.0	0.0	0.0	0.0
Total Delay	151.2	74.7	67.6	64.5	2.1	10.1	15.1	86.2	18.3	5.1
Queue Length 50th (ft)	~235	81	135	59	0	22	174	47	311	33
Queue Length 95th (ft)	#405	118	204	91	0	43	250	92	415	68
Internal Link Dist (ft)		316		456			473		500	
Turn Bay Length (ft)	220		185		60	350		185		70
Base Capacity (vph)	204	647	234	735	400	328	1882	122	1966	972
Starvation Cap Reductn	0	0	0	0	0	0	0	0	0	0
Spillback Cap Reductn	0	0	0	0	0	0	0	0	0	0
Storage Cap Reductn	0	0	0	0	0	0	0	0	0	0
Reduced v/c Ratio	1.12	0.25	0.68	0.17	0.13	0.23	0.39	0.40	0.56	0.19

Intersection Summary

~ Volume exceeds capacity, queue is theoretically infinite.























Queue shown is maximum after two cycles.

95th percentile volume exceeds capacity, queue may be longer.

Queue shown is maximum after two cycles.

HCM 6th Signalized Intersection Summary

104: Alton Road & Dade Boulevard

												
Movement	EBL	EBT	EBR	WBL	WBT	WBR	NBL	NBT	NBR	SBL	SBT	SBR
Lane Configurations												
Traffic Volume (veh/h)	208	140	9	144	112	48	70	486	176	45	994	171
Future Volume (veh/h)	208	140	9	144	112	48	70	486	176	45	994	171
Initial Q (Qb), veh	0	0	0	0	0	0	0	0	0	0	0	0
Ped-Bike Adj(A_pbT)	0.98		1.00	0.99		1.00	1.00		0.98	1.00		0.98
Parking Bus, Adj	1.00	1.00	1.00	1.00	1.00	1.00	1.00	1.00	1.00	1.00	1.00	1.00
Work Zone On Approach		No			No			No			No	
Adj Sat Flow, veh/h/ln	1670	1670	1670	1670	1670	1670	1670	1670	1670	1670	1670	1670
Adj Flow Rate, veh/h	229	154	0	158	123	0	77	534	193	49	1092	188
Peak Hour Factor	0.91	0.91	0.91	0.91	0.91	0.91	0.91	0.91	0.91	0.91	0.91	0.91
Percent Heavy Veh, %	3	3	3	3	3	3	3	3	3	3	3	3
Cap, veh/h	255	305		254	390		261	1395	502	61	1969	957
Arrive On Green	0.07	0.10	0.00	0.10	0.12	0.00	0.03	0.61	0.61	0.04	0.62	0.62
Sat Flow, veh/h	1590	3256	0	1590	3173	1415	1590	2272	818	1590	3173	1385
Grp Volume(v), veh/h	229	154	0	158	123	0	77	372	355	49	1092	188
Grp Sat Flow(s),veh/h/ln	1590	1586	0	1590	1586	1415	1590	1586	1503	1590	1586	1385
Q Serve(g_s), s	10.3	6.9	0.0	13.3	5.3	0.0	2.7	17.7	17.9	4.6	29.9	7.3
Cycle Q Clear(g_c), s	10.3	6.9	0.0	13.3	5.3	0.0	2.7	17.7	17.9	4.6	29.9	7.3
Prop In Lane	1.00		0.00	1.00		1.00	1.00		0.54	1.00		1.00
Lane Grp Cap(c), veh/h	255	305		254	390		261	974	923	61	1969	957
V/C Ratio(X)	0.90	0.50		0.62	0.32		0.29	0.38	0.38	0.80	0.55	0.20
Avail Cap(c_a), veh/h	255	656		254	719		330	974	923	120	1969	957
HCM Platoon Ratio	1.00	1.00	1.00	1.00	1.00	1.00	1.00	1.00	1.00	1.00	1.00	1.00
Upstream Filter(I)	1.00	1.00	0.00	1.00	1.00	0.00	1.00	1.00	1.00	1.00	1.00	1.00
Uniform Delay (d), s/veh	62.9	64.4	0.0	54.4	60.0	0.0	13.4	14.6	14.6	71.6	16.5	8.4
Incr Delay (d2), s/veh	30.5	1.0	0.0	3.5	0.3	0.0	0.2	1.1	1.2	8.9	1.1	0.5
Initial Q Delay(d3),s/veh	0.0	0.0	0.0	0.0	0.0	0.0	0.0	0.0	0.0	0.0	0.0	0.0
%ile BackOfQ(50%),veh/ln	6.5	2.9	0.0	5.6	2.2	0.0	1.0	6.7	6.4	2.0	11.1	2.3
Unsig. Movement Delay, s/veh												
LnGrp Delay(d),s/veh	93.4	65.3	0.0	57.8	60.4	0.0	13.6	15.7	15.8	80.5	17.6	8.8
LnGrp LOS	F	E		E	E		B	B	B	F	B	A
Approach Vol, veh/h		383			281			804			1329	
Approach Delay, s/veh		82.1			58.9			15.6			18.7	
Approach LOS		F			E			B			B	
Timer - Assigned Phs	1	2	3	4	5	6	7	8				
Phs Duration (G+Y+Rc), s	10.5	99.1	16.0	24.4	11.4	98.1	20.0	20.4				
Change Period (Y+Rc), s	* 5.7	6.0	* 5.7	6.0	* 5.7	6.0	* 5.7	6.0				
Max Green Setting (Gmax), s	* 11	70.0	* 10	34.0	* 11	70.0	* 14	31.0				
Max Q Clear Time (g_c+I1), s	4.7	31.9	12.3	7.3	6.6	19.9	15.3	8.9				
Green Ext Time (p_c), s	0.0	3.5	0.0	0.6	0.0	1.7	0.0	0.7				
Intersection Summary												
HCM 6th Ctrl Delay			30.5									
HCM 6th LOS			C									
Notes												
* HCM 6th computational engine requires equal clearance times for the phases crossing the barrier.												
Unsignalized Delay for [EBR, WBR] is excluded from calculations of the approach delay and intersection delay.												

Timings

105: Dade Blvd & Michigan Ave



Lane Group	EBT	WBT	WBR	SEL	SER	Ø3
Lane Configurations	↑↑	↑↑	↑	↑↑	↑	
Traffic Volume (vph)	330	275	281	474	25	
Future Volume (vph)	330	275	281	474	25	
Turn Type	NA	NA	pm+ov	Prot	Perm	
Protected Phases	6	2	4	4		3
Permitted Phases			2		4	
Detector Phase	6	2	4	4	4	
Switch Phase						
Minimum Initial (s)	14.0	14.0	7.0	7.0	7.0	1.0
Minimum Split (s)	36.0	36.0	20.6	20.6	20.6	27.0
Total Split (s)	39.0	39.0	54.0	54.0	54.0	27.0
Total Split (%)	32.5%	32.5%	45.0%	45.0%	45.0%	23%
Yellow Time (s)	4.0	4.0	4.0	4.0	4.0	2.0
All-Red Time (s)	2.0	2.0	2.0	2.0	2.0	0.0
Lost Time Adjust (s)	0.0	0.0	0.0	0.0	0.0	
Total Lost Time (s)	6.0	6.0	6.0	6.0	6.0	
Lead/Lag			Lag	Lag	Lag	Lead
Lead-Lag Optimize?			Yes	Yes	Yes	Yes
Recall Mode	C-Max	C-Max	None	None	None	None
Act Effct Green (s)	79.6	79.6	120.0	28.4	28.4	
Actuated g/C Ratio	0.66	0.66	1.00	0.24	0.24	
v/c Ratio	0.17	0.14	0.22	0.72	0.08	
Control Delay	8.5	8.3	0.3	47.1	11.0	
Queue Delay	0.0	0.0	0.0	0.0	0.0	
Total Delay	8.5	8.3	0.3	47.1	11.0	
LOS	A	A	A	D	B	
Approach Delay	8.5	4.3		45.3		
Approach LOS	A	A		D		

Intersection Summary

Cycle Length: 120
 Actuated Cycle Length: 120
 Offset: 117 (98%), Referenced to phase 2:WBT and 6:EBT, Start of Yellow
 Natural Cycle: 85
 Control Type: Actuated-Coordinated
 Maximum v/c Ratio: 0.72
 Intersection Signal Delay: 20.1
 Intersection Capacity Utilization 35.2%
 Analysis Period (min) 15

Intersection LOS: C
 ICU Level of Service A

Splits and Phases: 105: Dade Blvd & Michigan Ave

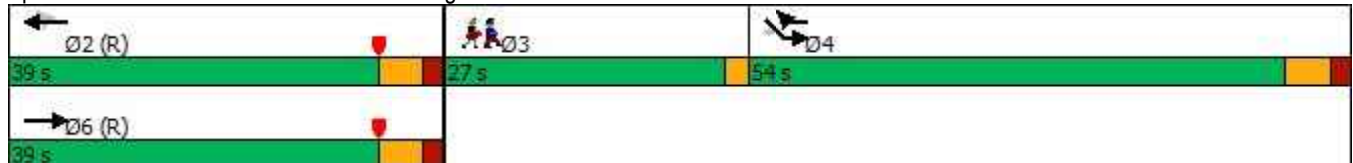

Queues

105: Dade Blvd & Michigan Ave



Lane Group	EBT	WBT	WBR	SEL	SER
Lane Group Flow (vph)	402	335	343	578	30
v/c Ratio	0.17	0.14	0.22	0.72	0.08
Control Delay	8.5	8.3	0.3	47.1	11.0
Queue Delay	0.0	0.0	0.0	0.0	0.0
Total Delay	8.5	8.3	0.3	47.1	11.0
Queue Length 50th (ft)	56	46	0	213	0
Queue Length 95th (ft)	84	71	0	226	19
Internal Link Dist (ft)	166	341		11	
Turn Bay Length (ft)			280		
Base Capacity (vph)	2325	2325	1568	1360	645
Starvation Cap Reductn	0	0	0	0	0
Spillback Cap Reductn	0	0	0	0	0
Storage Cap Reductn	0	0	0	0	0
Reduced v/c Ratio	0.17	0.14	0.22	0.42	0.05

Intersection Summary

HCM Signalized Intersection Capacity Analysis

105: Dade Blvd & Michigan Ave



Movement	EBL	EBT	WBT	WBR	SEL	SER
Lane Configurations		↑↑	↑↑	↑	↑↑	↑
Traffic Volume (vph)	0	330	275	281	474	25
Future Volume (vph)	0	330	275	281	474	25
Ideal Flow (vphpl)	1900	1900	1900	1900	1900	1900
Total Lost time (s)		6.0	6.0	6.0	6.0	6.0
Lane Util. Factor		0.95	0.95	1.00	0.97	1.00
Frbp, ped/bikes		1.00	1.00	1.00	1.00	1.00
Flpb, ped/bikes		1.00	1.00	1.00	1.00	1.00
Frt		1.00	1.00	0.85	1.00	0.85
Flt Protected		1.00	1.00	1.00	0.95	1.00
Satd. Flow (prot)		3505	3505	1568	3400	1568
Flt Permitted		1.00	1.00	1.00	0.95	1.00
Satd. Flow (perm)		3505	3505	1568	3400	1568
Peak-hour factor, PHF	0.82	0.82	0.82	0.82	0.82	0.82
Adj. Flow (vph)	0	402	335	343	578	30
RTOR Reduction (vph)	0	0	0	34	0	23
Lane Group Flow (vph)	0	402	335	309	578	7
Confl. Peds. (#/hr)	4					
Turn Type		NA	NA	pm+ov	Prot	Perm
Protected Phases		6	2	4	4	
Permitted Phases				2		4
Actuated Green, G (s)		79.6	79.6	108.0	28.4	28.4
Effective Green, g (s)		79.6	79.6	108.0	28.4	28.4
Actuated g/C Ratio		0.66	0.66	0.90	0.24	0.24
Clearance Time (s)		6.0	6.0	6.0	6.0	6.0
Vehicle Extension (s)		1.0	1.0	3.5	3.5	3.5
Lane Grp Cap (vph)		2324	2324	1568	804	371
v/s Ratio Prot		0.11	0.10	c0.05	c0.17	
v/s Ratio Perm				0.15		0.00
v/c Ratio		0.17	0.14	0.20	0.72	0.02
Uniform Delay, d1		7.7	7.5	0.7	42.1	35.1
Progression Factor		1.00	1.00	1.00	1.00	1.00
Incremental Delay, d2		0.2	0.1	0.1	3.2	0.0
Delay (s)		7.8	7.7	0.8	45.3	35.1
Level of Service		A	A	A	D	D
Approach Delay (s)		7.8	4.2		44.8	
Approach LOS		A	A		D	
Intersection Summary						
HCM 2000 Control Delay			19.7		HCM 2000 Level of Service	B
HCM 2000 Volume to Capacity ratio			0.35			
Actuated Cycle Length (s)			120.0		Sum of lost time (s)	14.0
Intersection Capacity Utilization			35.2%		ICU Level of Service	A
Analysis Period (min)			15			
c Critical Lane Group						

HCM 6th Signalized Intersection Summary
105: Dade Blvd & Michigan Ave

HCM 6th Edition methodology does not support exclusive ped or hold phases.

HCM 6th TWSC
201: 19 St & Driveway

Intersection						
Int Delay, s/veh	4.1					
Movement	EBL	EBT	WBT	WBR	SBL	SBR
Lane Configurations		4	1		1	
Traffic Vol, veh/h	41	23	38	19	29	12
Future Vol, veh/h	41	23	38	19	29	12
Conflicting Peds, #/hr	0	0	0	0	0	0
Sign Control	Free	Free	Free	Free	Stop	Stop
RT Channelized	-	None	-	None	-	None
Storage Length	-	-	-	-	0	-
Veh in Median Storage, #	-	0	0	-	0	-
Grade, %	-	0	0	-	0	-
Peak Hour Factor	92	92	92	92	92	92
Heavy Vehicles, %	3	3	3	3	3	3
Mvmt Flow	45	25	41	21	32	13

Major/Minor	Major1	Major2	Minor2		
Conflicting Flow All	62	0	-	0	167 52
Stage 1	-	-	-	-	52 -
Stage 2	-	-	-	-	115 -
Critical Hdwy	4.13	-	-	-	5 4.5
Critical Hdwy Stg 1	-	-	-	-	5 -
Critical Hdwy Stg 2	-	-	-	-	5 -
Follow-up Hdwy	2.227	-	-	-	3 3
Pot Cap-1 Maneuver	1535	-	-	-	1019 1149
Stage 1	-	-	-	-	1141 -
Stage 2	-	-	-	-	1073 -
Platoon blocked, %		-	-	-	
Mov Cap-1 Maneuver	1535	-	-	-	988 1149
Mov Cap-2 Maneuver	-	-	-	-	988 -
Stage 1	-	-	-	-	1107 -
Stage 2	-	-	-	-	1073 -

Approach	EB	WB	SB
HCM Control Delay, s	4.8	0	8.7
HCM LOS			A

Minor Lane/Major Mvmt	EBL	EBT	WBT	WBR	SBLn1
Capacity (veh/h)	1535	-	-	-	1030
HCM Lane V/C Ratio	0.029	-	-	-	0.043
HCM Control Delay (s)	7.4	0	-	-	8.7
HCM Lane LOS	A	A	-	-	A
HCM 95th %tile Q(veh)	0.1	-	-	-	0.1

Timings

104: Alton Road & Dade Boulevard

09/18/2023



Lane Group	EBL	EBT	WBL	WBT	WBR	NBL	NBT	SBL	SBT	SBR
Lane Configurations										
Traffic Volume (vph)	208	140	144	112	48	70	486	45	994	171
Future Volume (vph)	208	140	144	112	48	70	486	45	994	171
Turn Type	pm+pt	NA	pm+pt	NA	Perm	pm+pt	NA	Prot	NA	pm+ov
Protected Phases	3	8	7	4		1	6	5	2	3
Permitted Phases	8		4		4	6				2
Detector Phase	3	8	7	4	4	1	6	5	2	3
Switch Phase										
Minimum Initial (s)	5.0	7.0	5.0	7.0	7.0	5.0	4.0	5.0	4.0	5.0
Minimum Split (s)	11.0	37.0	11.0	37.0	37.0	11.0	29.0	11.0	29.0	11.0
Total Split (s)	19.0	37.0	20.0	38.0	38.0	17.0	76.0	17.0	76.0	19.0
Total Split (%)	12.7%	24.7%	13.3%	25.3%	25.3%	11.3%	50.7%	11.3%	50.7%	12.7%
Yellow Time (s)	3.7	4.0	3.7	4.0	4.0	3.7	4.0	3.7	4.0	3.7
All-Red Time (s)	2.0	2.0	2.0	2.0	2.0	2.0	2.0	2.0	2.0	2.0
Lost Time Adjust (s)	0.0	0.0	0.0	0.0	0.0	0.0	0.0	0.0	0.0	0.0
Total Lost Time (s)	5.7	6.0	5.7	6.0	6.0	5.7	6.0	5.7	6.0	5.7
Lead/Lag	Lead	Lag	Lead	Lag	Lag	Lead	Lag	Lead	Lag	Lead
Lead-Lag Optimize?	Yes	Yes	Yes	Yes	Yes	Yes	Yes	Yes	Yes	Yes
Recall Mode	None	None	None	None	None	None	C-Max	None	C-Max	None
Act Effct Green (s)	26.4	12.8	27.1	13.1	13.1	99.4	93.2	9.1	93.4	107.0
Actuated g/C Ratio	0.18	0.09	0.18	0.09	0.09	0.66	0.62	0.06	0.62	0.71
v/c Ratio	0.97	0.61	0.69	0.45	0.25	0.27	0.39	0.52	0.56	0.19
Control Delay	106.7	74.1	67.2	69.3	2.7	10.1	15.1	86.2	18.4	4.4
Queue Delay	0.0	0.0	0.0	0.0	0.0	0.0	0.0	0.0	0.0	0.0
Total Delay	106.7	74.1	67.2	69.3	2.7	10.1	15.1	86.2	18.4	4.4
LOS	F	E	E	E	A	B	B	F	B	A
Approach Delay		93.1		57.8			14.6		18.9	
Approach LOS		F		E			B		B	

Intersection Summary

Cycle Length: 150
 Actuated Cycle Length: 150
 Offset: 25 (17%), Referenced to phase 2:SBT and 6:NBTL, Start of Yellow
 Natural Cycle: 90
 Control Type: Actuated-Coordinated
 Maximum v/c Ratio: 0.97
 Intersection Signal Delay: 32.4
 Intersection Capacity Utilization 74.3%
 Analysis Period (min) 15

Intersection LOS: C
 ICU Level of Service D

Splits and Phases: 104: Alton Road & Dade Boulevard

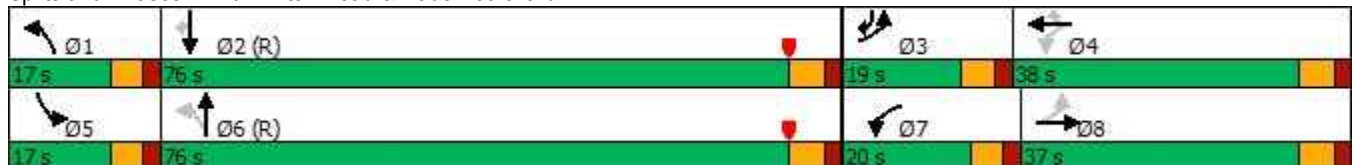

Queues

104: Alton Road & Dade Boulevard

09/18/2023



Lane Group	EBL	EBT	WBL	WBT	WBR	NBL	NBT	SBL	SBT	SBR
Lane Group Flow (vph)	229	164	158	123	53	77	727	49	1092	188
v/c Ratio	0.97	0.61	0.69	0.45	0.25	0.27	0.39	0.52	0.56	0.19
Control Delay	106.7	74.1	67.2	69.3	2.7	10.1	15.1	86.2	18.4	4.4
Queue Delay	0.0	0.0	0.0	0.0	0.0	0.0	0.0	0.0	0.0	0.0
Total Delay	106.7	74.1	67.2	69.3	2.7	10.1	15.1	86.2	18.4	4.4
Queue Length 50th (ft)	207	81	135	61	0	22	174	47	311	29
Queue Length 95th (ft)	#359	118	204	94	0	43	250	92	415	61
Internal Link Dist (ft)		316		456			473		500	
Turn Bay Length (ft)	220		185		60	350		185		70
Base Capacity (vph)	237	647	237	672	375	328	1879	122	1962	999
Starvation Cap Reductn	0	0	0	0	0	0	0	0	0	0
Spillback Cap Reductn	0	0	0	0	0	0	0	0	0	0
Storage Cap Reductn	0	0	0	0	0	0	0	0	0	0
Reduced v/c Ratio	0.97	0.25	0.67	0.18	0.14	0.23	0.39	0.40	0.56	0.19

Intersection Summary

95th percentile volume exceeds capacity, queue may be longer.
 Queue shown is maximum after two cycles.

HCM 6th Signalized Intersection Summary
 104: Alton Road & Dade Boulevard

09/18/2023

Movement	EBL	EBT	EBR	WBL	WBT	WBR	NBL	NBT	NBR	SBL	SBT	SBR
Lane Configurations												
Traffic Volume (veh/h)	208	140	9	144	112	48	70	486	176	45	994	171
Future Volume (veh/h)	208	140	9	144	112	48	70	486	176	45	994	171
Initial Q (Qb), veh	0	0	0	0	0	0	0	0	0	0	0	0
Ped-Bike Adj(A_pbT)	0.99		1.00	0.99		1.00	1.00		0.98	1.00		0.98
Parking Bus, Adj	1.00	1.00	1.00	1.00	1.00	1.00	1.00	1.00	1.00	1.00	1.00	1.00
Work Zone On Approach		No			No			No			No	
Adj Sat Flow, veh/h/ln	1670	1670	1670	1670	1670	1670	1670	1670	1670	1670	1670	1670
Adj Flow Rate, veh/h	229	154	0	158	123	0	77	534	193	49	1092	188
Peak Hour Factor	0.91	0.91	0.91	0.91	0.91	0.91	0.91	0.91	0.91	0.91	0.91	0.91
Percent Heavy Veh, %	3	3	3	3	3	3	3	3	3	3	3	3
Cap, veh/h	264	305		254	327		261	1395	502	61	1969	985
Arrive On Green	0.09	0.10	0.00	0.10	0.10	0.00	0.03	0.61	0.61	0.04	0.62	0.62
Sat Flow, veh/h	1590	3256	0	1590	3173	1415	1590	2272	818	1590	3173	1385
Grp Volume(v), veh/h	229	154	0	158	123	0	77	372	355	49	1092	188
Grp Sat Flow(s),veh/h/ln	1590	1586	0	1590	1586	1415	1590	1586	1503	1590	1586	1385
Q Serve(g_s), s	13.3	6.9	0.0	13.4	5.4	0.0	2.7	17.7	17.9	4.6	29.9	6.9
Cycle Q Clear(g_c), s	13.3	6.9	0.0	13.4	5.4	0.0	2.7	17.7	17.9	4.6	29.9	6.9
Prop In Lane	1.00		0.00	1.00		1.00	1.00		0.54	1.00		1.00
Lane Grp Cap(c), veh/h	264	305		254	327		261	974	923	61	1969	985
V/C Ratio(X)	0.87	0.50		0.62	0.38		0.29	0.38	0.38	0.80	0.55	0.19
Avail Cap(c_a), veh/h	264	656		254	677		330	974	923	120	1969	985
HCM Platoon Ratio	1.00	1.00	1.00	1.00	1.00	1.00	1.00	1.00	1.00	1.00	1.00	1.00
Upstream Filter(I)	1.00	1.00	0.00	1.00	1.00	0.00	1.00	1.00	1.00	1.00	1.00	1.00
Uniform Delay (d), s/veh	60.4	64.4	0.0	54.6	62.8	0.0	13.4	14.6	14.6	71.6	16.5	7.3
Incr Delay (d2), s/veh	24.3	1.0	0.0	3.5	0.5	0.0	0.2	1.1	1.2	8.9	1.1	0.4
Initial Q Delay(d3),s/veh	0.0	0.0	0.0	0.0	0.0	0.0	0.0	0.0	0.0	0.0	0.0	0.0
%ile BackOfQ(50%),veh/ln	4.8	2.9	0.0	5.6	2.2	0.0	1.0	6.7	6.4	2.0	11.1	0.1
Unsig. Movement Delay, s/veh												
LnGrp Delay(d),s/veh	84.7	65.3	0.0	58.1	63.3	0.0	13.6	15.7	15.8	80.5	17.6	7.8
LnGrp LOS	F	E		E	E		B	B	B	F	B	A
Approach Vol, veh/h		383			281			804			1329	
Approach Delay, s/veh		76.9			60.4			15.6			18.5	
Approach LOS		E			E			B			B	
Timer - Assigned Phs	1	2	3	4	5	6	7	8				
Phs Duration (G+Y+Rc), s	10.5	99.1	19.0	21.4	11.4	98.1	20.0	20.4				
Change Period (Y+Rc), s	* 5.7	6.0	* 5.7	6.0	* 5.7	6.0	* 5.7	6.0				
Max Green Setting (Gmax), s	* 11	70.0	* 13	32.0	* 11	70.0	* 14	31.0				
Max Q Clear Time (g_c+I1), s	4.7	31.9	15.3	7.4	6.6	19.9	15.4	8.9				
Green Ext Time (p_c), s	0.0	3.5	0.0	0.6	0.0	1.7	0.0	0.7				

Intersection Summary

HCM 6th Ctrl Delay	29.9
HCM 6th LOS	C

Notes

* HCM 6th computational engine requires equal clearance times for the phases crossing the barrier.
 Unsignalized Delay for [EBR, WBR] is excluded from calculations of the approach delay and intersection delay.

Timings

101: Alton Rd & N Michigan Ave



Lane Group	SEL	SET	NWL	NWT	NWR	NEL	NET	SWL	SWT
Lane Configurations		↕		↕	↕	↕	↕↔	↕↔	↕↔
Traffic Volume (vph)	14	12	24	15	627	5	1177	288	924
Future Volume (vph)	14	12	24	15	627	5	1177	288	924
Turn Type	Perm	NA	Perm	NA	Free	Prot	NA	Prot	NA
Protected Phases		8		4		1	6	5	2
Permitted Phases	8		4		Free				
Detector Phase	8	8	4	4		1	6	5	2
Switch Phase									
Minimum Initial (s)	7.0	7.0	7.0	7.0		5.0	14.0	5.0	14.0
Minimum Split (s)	36.3	36.3	36.3	36.3		10.7	27.0	10.7	27.0
Total Split (s)	36.3	36.3	36.3	36.3		48.7	65.0	48.7	65.0
Total Split (%)	24.2%	24.2%	24.2%	24.2%		32.5%	43.3%	32.5%	43.3%
Yellow Time (s)	4.0	4.0	4.0	4.0		3.7	4.0	3.7	4.0
All-Red Time (s)	2.3	2.3	2.3	2.3		2.0	2.0	2.0	2.0
Lost Time Adjust (s)		-1.0		-1.0		-1.0	-1.0	1.0	1.0
Total Lost Time (s)		5.3		5.3		4.7	5.0	6.7	7.0
Lead/Lag						Lead	Lag	Lead	Lag
Lead-Lag Optimize?						Yes	Yes	Yes	Yes
Recall Mode	None	None	None	None		None	C-Max	None	C-Max
Act Effct Green (s)		10.6		10.6	150.0	10.1	103.2	21.8	128.0
Actuated g/C Ratio		0.07		0.07	1.00	0.07	0.69	0.15	0.85
v/c Ratio		0.29		0.43	0.46	0.05	0.57	0.67	0.36
Control Delay		69.0		80.3	1.1	72.4	12.9	67.8	4.2
Queue Delay		0.0		0.0	0.0	0.0	0.1	0.0	0.0
Total Delay		69.0		80.3	1.1	72.4	13.1	67.8	4.2
LOS		E		F	A	E	B	E	A
Approach Delay		69.0		5.7			13.3		19.2
Approach LOS		E		A			B		B

Intersection Summary

Cycle Length: 150
 Actuated Cycle Length: 150
 Offset: 118 (79%), Referenced to phase 2:SWT and 6:NET, Start of Yellow
 Natural Cycle: 90
 Control Type: Actuated-Coordinated
 Maximum v/c Ratio: 0.67
 Intersection Signal Delay: 14.5
 Intersection Capacity Utilization 70.8%
 Analysis Period (min) 15
 Intersection LOS: B
 ICU Level of Service C

Splits and Phases: 101: Alton Rd & N Michigan Ave

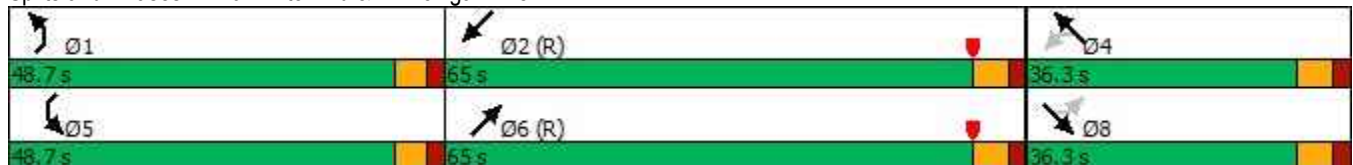

Queues

101: Alton Rd & N Michigan Ave



Lane Group	SET	NWT	NWR	NEL	NET	SWL	SWT
Lane Group Flow (vph)	28	40	646	5	1238	297	958
v/c Ratio	0.29	0.43	0.46	0.05	0.57	0.67	0.36
Control Delay	69.0	80.3	1.1	72.4	12.9	67.8	4.2
Queue Delay	0.0	0.0	0.0	0.0	0.1	0.0	0.0
Total Delay	69.0	80.3	1.1	72.4	13.1	67.8	4.2
Queue Length 50th (ft)	25	38	0	4	395	143	83
Queue Length 95th (ft)	58	79	0	m11	533	187	222
Internal Link Dist (ft)	247	552			268		227
Turn Bay Length (ft)				100		265	
Base Capacity (vph)	280	271	1411	462	2189	856	2688
Starvation Cap Reductn	0	0	0	0	215	0	0
Spillback Cap Reductn	0	0	0	0	0	0	130
Storage Cap Reductn	0	0	0	0	0	0	0
Reduced v/c Ratio	0.10	0.15	0.46	0.01	0.63	0.35	0.37

Intersection Summary

m Volume for 95th percentile queue is metered by upstream signal.

HCM 6th Signalized Intersection Summary

101: Alton Rd & N Michigan Ave



Movement	SEL	SET	SER	NWL	NWT	NWR	NEL	NET	NER	SWL	SWT	SWR
Lane Configurations		↔			↔	↔	↔	↕↔		↕↔	↕↔	
Traffic Volume (veh/h)	14	12	2	24	15	627	5	1177	24	288	924	5
Future Volume (veh/h)	14	12	2	24	15	627	5	1177	24	288	924	5
Initial Q (Qb), veh	0	0	0	0	0	0	0	0	0	0	0	0
Ped-Bike Adj(A_pbT)	0.99		0.98	0.99		1.00	1.00		0.98	1.00		0.98
Parking Bus, Adj	1.00	1.00	1.00	1.00	1.00	1.00	1.00	1.00	1.00	1.00	1.00	1.00
Work Zone On Approach		No			No			No			No	
Adj Sat Flow, veh/h/ln	1670	1670	1670	1670	1670	1670	1670	1670	1670	1670	1670	1670
Adj Flow Rate, veh/h	14	12	2	25	15	0	5	1213	25	297	953	5
Peak Hour Factor	0.97	0.97	0.97	0.97	0.97	0.97	0.97	0.97	0.97	0.97	0.97	0.97
Percent Heavy Veh, %	3	3	3	3	3	3	3	3	3	3	3	3
Cap, veh/h	81	58	8	97	48		21	2184	45	384	2585	14
Arrive On Green	0.07	0.07	0.07	0.07	0.07	0.00	0.03	1.00	1.00	0.12	0.80	0.81
Sat Flow, veh/h	595	777	106	779	645	1415	1590	3178	65	3086	3236	17
Grp Volume(v), veh/h	28	0	0	40	0	0	5	605	633	297	467	491
Grp Sat Flow(s),veh/h/ln	1477	0	0	1425	0	1415	1590	1586	1657	1543	1586	1666
Q Serve(g_s), s	0.0	0.0	0.0	1.3	0.0	0.0	0.5	0.0	0.0	14.0	12.6	12.6
Cycle Q Clear(g_c), s	2.4	0.0	0.0	3.7	0.0	0.0	0.5	0.0	0.0	14.0	12.6	12.6
Prop In Lane	0.50		0.07	0.62		1.00	1.00		0.04	1.00		0.01
Lane Grp Cap(c), veh/h	147	0	0	146	0		21	1090	1138	384	1267	1331
V/C Ratio(X)	0.19	0.00	0.00	0.27	0.00		0.24	0.56	0.56	0.77	0.37	0.37
Avail Cap(c_a), veh/h	331	0	0	326	0		467	1090	1138	864	1267	1331
HCM Platoon Ratio	1.00	1.00	1.00	1.00	1.00	1.00	2.00	2.00	2.00	1.00	1.00	1.00
Upstream Filter(l)	1.00	0.00	0.00	1.00	0.00	0.00	0.89	0.89	0.89	1.00	1.00	1.00
Uniform Delay (d), s/veh	65.3	0.0	0.0	65.8	0.0	0.0	72.3	0.0	0.0	63.6	4.3	4.3
Incr Delay (d2), s/veh	0.5	0.0	0.0	0.7	0.0	0.0	18.6	1.8	1.7	11.3	0.8	0.8
Initial Q Delay(d3),s/veh	0.0	0.0	0.0	0.0	0.0	0.0	0.0	0.0	0.0	0.0	0.0	0.0
%ile BackOfQ(50%),veh/ln	1.0	0.0	0.0	1.5	0.0	0.0	0.3	0.6	0.6	6.1	3.8	4.0
Unsig. Movement Delay, s/veh												
LnGrp Delay(d),s/veh	65.8	0.0	0.0	66.5	0.0	0.0	91.0	1.8	1.7	75.0	5.1	5.1
LnGrp LOS	E	A	A	E	A		F	A	A	E	A	A
Approach Vol, veh/h		28			40			1243			1255	
Approach Delay, s/veh		65.8			66.5			2.1			21.6	
Approach LOS		E			E			A			C	
Timer - Assigned Phs	1	2		4	5	6		8				
Phs Duration (G+Y+Rc), s	6.6	126.8		16.5	25.4	108.1		16.5				
Change Period (Y+Rc), s	* 5.7	6.0		* 6.3	* 5.7	6.0		* 6.3				
Max Green Setting (Gmax), s	* 43	59.0		* 30	* 43	59.0		* 30				
Max Q Clear Time (g_c+I1), s	2.5	14.6		5.7	16.0	2.0		4.4				
Green Ext Time (p_c), s	0.0	0.8		0.1	3.7	1.1		0.0				

Intersection Summary

HCM 6th Ctrl Delay	13.4
HCM 6th LOS	B

Notes

* HCM 6th computational engine requires equal clearance times for the phases crossing the barrier.

Unsignalized Delay for [NWR] is excluded from calculations of the approach delay and intersection delay.

Timings

102: Alton Rd & 20 St/Sunset Harbour Dr



Lane Group	EBL	EBT	EBR	WBT	NEL	NET	SWL	SWT	SWR
Lane Configurations									
Traffic Volume (vph)	173	7	22	0	83	1028	5	774	187
Future Volume (vph)	173	7	22	0	83	1028	5	774	187
Turn Type	Split	NA	Perm	NA	pm+pt	NA	Perm	NA	Perm
Protected Phases	3	3		4	1	6		2	
Permitted Phases			3		6		2		2
Detector Phase	3	3	3	4	1	6	2	2	2
Switch Phase									
Minimum Initial (s)	7.0	7.0	7.0	7.0	5.0	7.0	7.0	7.0	7.0
Minimum Split (s)	32.0	32.0	32.0	13.3	11.0	43.3	43.3	43.3	43.3
Total Split (s)	33.0	33.0	33.0	18.0	12.0	99.0	87.0	87.0	87.0
Total Split (%)	22.0%	22.0%	22.0%	12.0%	8.0%	66.0%	58.0%	58.0%	58.0%
Yellow Time (s)	4.0	4.0	4.0	4.0	4.0	4.0	4.0	4.0	4.0
All-Red Time (s)	2.0	2.0	2.0	2.3	2.0	3.3	3.3	3.3	3.3
Lost Time Adjust (s)	-1.3	0.0	-1.3	-1.3	1.0	1.0	-1.5	-1.5	-1.5
Total Lost Time (s)	4.7	6.0	4.7	5.0	7.0	8.3	5.8	5.8	5.8
Lead/Lag	Lead	Lead	Lead	Lag	Lead		Lag	Lag	Lag
Lead-Lag Optimize?	Yes	Yes	Yes	Yes	Yes		Yes	Yes	Yes
Recall Mode	None	None	None	None	None	C-Max	C-Max	C-Max	C-Max
Act Effct Green (s)	15.6	14.3	15.6	8.3	117.4	116.1	106.0	106.0	106.0
Actuated g/C Ratio	0.10	0.10	0.10	0.06	0.78	0.77	0.71	0.71	0.71
v/c Ratio	0.61	0.65	0.09	0.06	0.20	0.44	0.02	0.36	0.19
Control Delay	79.9	85.3	0.7	0.5	6.4	7.7	8.8	10.7	5.2
Queue Delay	0.0	0.0	0.0	0.0	0.0	0.1	0.0	0.3	0.5
Total Delay	79.9	85.3	0.7	0.5	6.4	7.8	8.8	11.1	5.7
LOS	E	F	A	A	A	A	A	B	A
Approach Delay		73.6		0.5		7.7		10.0	
Approach LOS		E		A		A		B	

Intersection Summary

Cycle Length: 150
 Actuated Cycle Length: 150
 Offset: 129 (86%), Referenced to phase 2:SWTL and 6:NETL, Start of Yellow
 Natural Cycle: 100
 Control Type: Actuated-Coordinated
 Maximum v/c Ratio: 0.65
 Intersection Signal Delay: 14.4
 Intersection Capacity Utilization 66.5%
 Analysis Period (min) 15
 Intersection LOS: B
 ICU Level of Service C

Splits and Phases: 102: Alton Rd & 20 St/Sunset Harbour Dr

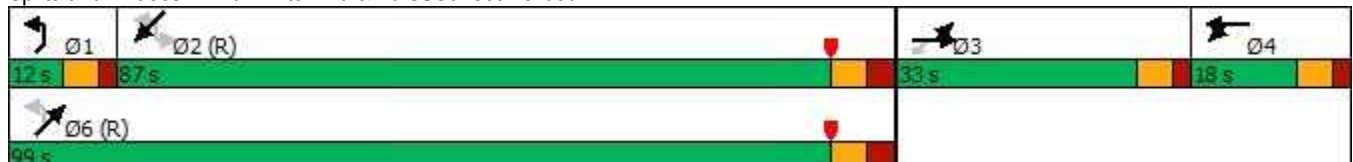

Queues

102: Alton Rd & 20 St/Sunset Harbour Dr



Lane Group	EBL	EBT	EBR	WBT	NEL	NET	SWL	SWT	SWR
Lane Group Flow (vph)	94	93	23	13	86	1075	5	806	195
v/c Ratio	0.61	0.65	0.09	0.06	0.20	0.44	0.02	0.36	0.19
Control Delay	79.9	85.3	0.7	0.5	6.4	7.7	8.8	10.7	5.2
Queue Delay	0.0	0.0	0.0	0.0	0.0	0.1	0.0	0.3	0.5
Total Delay	79.9	85.3	0.7	0.5	6.4	7.8	8.8	11.1	5.7
Queue Length 50th (ft)	93	93	0	0	14	134	2	162	36
Queue Length 95th (ft)	154	154	0	0	45	298	m6	303	110
Internal Link Dist (ft)		202		173		325		268	
Turn Bay Length (ft)					270		110		120
Base Capacity (vph)	282	271	364	261	426	2439	312	2227	1017
Starvation Cap Reductn	0	0	0	0	0	0	0	756	498
Spillback Cap Reductn	0	0	0	37	0	331	0	0	0
Storage Cap Reductn	0	0	0	0	0	0	0	0	0
Reduced v/c Ratio	0.33	0.34	0.06	0.06	0.20	0.51	0.02	0.55	0.38

Intersection Summary

m Volume for 95th percentile queue is metered by upstream signal.

HCM Signalized Intersection Capacity Analysis

102: Alton Rd & 20 St/Sunset Harbour Dr

Movement	EBL	EBT	EBR	WBL	WBT	WBR	NEL	NET	NER	SWL	SWT	SWR
Lane Configurations												
Traffic Volume (vph)	173	7	22	0	0	12	83	1028	4	5	774	187
Future Volume (vph)	173	7	22	0	0	12	83	1028	4	5	774	187
Ideal Flow (vphpl)	1900	1900	1900	1900	1900	1900	1900	1900	1900	1900	1900	1900
Total Lost time (s)	4.7	6.0	4.7		5.0		7.0	8.3		5.8	5.8	5.8
Lane Util. Factor	0.95	0.95	1.00		1.00		1.00	0.95		1.00	0.95	1.00
Frpb, ped/bikes	1.00	1.00	1.00		1.00		1.00	1.00		1.00	1.00	0.98
Flpb, ped/bikes	1.00	1.00	1.00		1.00		1.00	1.00		1.00	1.00	1.00
Frt	1.00	1.00	0.85		0.86		1.00	1.00		1.00	1.00	0.85
Flt Protected	0.95	0.96	1.00		1.00		0.95	1.00		0.95	1.00	1.00
Satd. Flow (prot)	1498	1507	1411		1436		1577	3153		1577	3154	1382
Flt Permitted	0.95	0.96	1.00		1.00		0.30	1.00		0.27	1.00	1.00
Satd. Flow (perm)	1498	1507	1411		1436		490	3153		442	3154	1382
Peak-hour factor, PHF	0.96	0.96	0.96	0.96	0.96	0.96	0.96	0.96	0.96	0.96	0.96	0.96
Adj. Flow (vph)	180	7	23	0	0	12	86	1071	4	5	806	195
RTOR Reduction (vph)	0	0	21	0	13	0	0	0	0	0	0	45
Lane Group Flow (vph)	94	93	2	0	0	0	86	1075	0	5	806	150
Confl. Bikes (#/hr)												1
Turn Type	Split	NA	Perm		NA		pm+pt	NA		Perm	NA	Perm
Protected Phases	3	3		4	4		1	6			2	
Permitted Phases			3				6			2		2
Actuated Green, G (s)	14.3	14.3	14.3		2.8		113.3	113.3		100.6	100.6	100.6
Effective Green, g (s)	15.6	14.3	15.6		4.1		112.3	112.3		102.1	102.1	102.1
Actuated g/C Ratio	0.10	0.10	0.10		0.03		0.75	0.75		0.68	0.68	0.68
Clearance Time (s)	6.0	6.0	6.0		6.3		6.0	7.3		7.3	7.3	7.3
Vehicle Extension (s)	2.5	2.5	2.5		2.5		2.0	1.0		1.0	1.0	1.0
Lane Grp Cap (vph)	155	143	146		39		408	2360		300	2146	940
v/s Ratio Prot	c0.06	0.06			c0.00		0.01	c0.34			0.26	
v/s Ratio Perm			0.00				0.15			0.01		0.11
v/c Ratio	0.61	0.65	0.02		0.01		0.21	0.46		0.02	0.38	0.16
Uniform Delay, d1	64.3	65.4	60.3		71.0		6.0	7.2		7.7	10.3	8.6
Progression Factor	1.00	1.00	1.00		1.00		1.00	1.00		0.80	1.00	1.40
Incremental Delay, d2	5.6	9.1	0.0		0.1		0.1	0.6		0.1	0.5	0.3
Delay (s)	69.8	74.5	60.3		71.0		6.1	7.8		6.3	10.7	12.4
Level of Service	E	E	E		E		A	A		A	B	B
Approach Delay (s)		70.9			71.0			7.7			11.0	
Approach LOS		E			E			A			B	
Intersection Summary												
HCM 2000 Control Delay			15.0				HCM 2000 Level of Service					B
HCM 2000 Volume to Capacity ratio			0.48									
Actuated Cycle Length (s)			150.0				Sum of lost time (s)				23.8	
Intersection Capacity Utilization			66.5%				ICU Level of Service					C
Analysis Period (min)			15									
c Critical Lane Group												

HCM 6th Signalized Intersection Summary
102: Alton Rd & 20 St/Sunset Harbour Dr

HCM 6th Edition methodology expects strict NEMA phasing.

HCM 6th TWSC
103: Alton Rd & 19 St

Intersection						
Int Delay, s/veh	0.2					
Movement	WBL	WBR	NBT	NBR	SBL	SBT
Lane Configurations		↑	↑↑			↑↑
Traffic Vol, veh/h	0	32	1085	35	0	800
Future Vol, veh/h	0	32	1085	35	0	800
Conflicting Peds, #/hr	0	0	0	0	0	0
Sign Control	Stop	Stop	Free	Free	Free	Free
RT Channelized	-	None	-	None	-	None
Storage Length	-	0	-	-	-	-
Veh in Median Storage, #	0	-	0	-	-	0
Grade, %	0	-	0	-	-	0
Peak Hour Factor	92	92	92	92	92	92
Heavy Vehicles, %	3	3	3	3	3	3
Mvmt Flow	0	35	1179	38	0	870

Major/Minor	Minor1	Major1	Major2			
Conflicting Flow All	-	609	0	0	-	-
Stage 1	-	-	-	-	-	-
Stage 2	-	-	-	-	-	-
Critical Hdwy	-	4.5	-	-	-	-
Critical Hdwy Stg 1	-	-	-	-	-	-
Critical Hdwy Stg 2	-	-	-	-	-	-
Follow-up Hdwy	-	3	-	-	-	-
Pot Cap-1 Maneuver	0	715	-	-	0	-
Stage 1	0	-	-	-	0	-
Stage 2	0	-	-	-	0	-
Platoon blocked, %			-	-		-
Mov Cap-1 Maneuver	-	715	-	-	-	-
Mov Cap-2 Maneuver	-	-	-	-	-	-
Stage 1	-	-	-	-	-	-
Stage 2	-	-	-	-	-	-

Approach	WB	NB	SB
HCM Control Delay, s	10.3	0	0
HCM LOS	B		

Minor Lane/Major Mvmt	NBT	NBRWBLn1	SBT
Capacity (veh/h)	-	-	715
HCM Lane V/C Ratio	-	-	0.049
HCM Control Delay (s)	-	-	10.3
HCM Lane LOS	-	-	B
HCM 95th %tile Q(veh)	-	-	0.2

Timings

104: Alton Road & Dade Boulevard



Lane Group	EBL	EBT	WBL	WBT	WBR	NBL	NBT	SBL	SBT	SBR
Lane Configurations										
Traffic Volume (vph)	209	149	168	174	45	70	822	48	738	95
Future Volume (vph)	209	149	168	174	45	70	822	48	738	95
Turn Type	pm+pt	NA	pm+pt	NA	Perm	pm+pt	NA	Prot	NA	pm+ov
Protected Phases	3	8	7	4		1	6	5	2	3
Permitted Phases	8		4		4	6				2
Detector Phase	3	8	7	4	4	1	6	5	2	3
Switch Phase										
Minimum Initial (s)	5.0	7.0	5.0	7.0	7.0	5.0	4.0	5.0	4.0	5.0
Minimum Split (s)	11.0	37.0	11.0	37.0	37.0	11.0	29.0	11.0	29.0	11.0
Total Split (s)	16.0	37.0	20.0	40.0	40.0	17.0	76.0	17.0	76.0	16.0
Total Split (%)	10.7%	24.7%	13.3%	26.7%	26.7%	11.3%	50.7%	11.3%	50.7%	10.7%
Yellow Time (s)	3.7	4.0	3.7	4.0	4.0	3.7	4.0	3.7	4.0	3.7
All-Red Time (s)	2.0	2.0	2.0	2.0	2.0	2.0	2.0	2.0	2.0	2.0
Lost Time Adjust (s)	0.0	0.0	0.0	0.0	0.0	0.0	0.0	0.0	0.0	0.0
Total Lost Time (s)	5.7	6.0	5.7	6.0	6.0	5.7	6.0	5.7	6.0	5.7
Lead/Lag	Lead	Lag	Lead	Lag	Lag	Lead	Lag	Lead	Lag	Lead
Lead-Lag Optimize?	Yes	Yes	Yes	Yes	Yes	Yes	Yes	Yes	Yes	Yes
Recall Mode	None	None	None	None	None	None	C-Max	None	C-Max	None
Act Effct Green (s)	24.1	13.5	31.5	17.2	17.2	98.0	91.9	9.4	92.2	102.8
Actuated g/C Ratio	0.16	0.09	0.21	0.11	0.11	0.65	0.61	0.06	0.61	0.69
v/c Ratio	1.13	0.65	0.80	0.53	0.19	0.20	0.59	0.54	0.42	0.11
Control Delay	151.6	73.7	77.1	67.5	1.7	9.3	20.5	86.9	16.4	3.5
Queue Delay	0.0	0.0	0.0	0.0	0.0	0.0	0.0	0.0	0.0	0.0
Total Delay	151.6	73.7	77.1	67.5	1.7	9.3	20.5	86.9	16.4	3.5
LOS	F	E	E	E	A	A	C	F	B	A
Approach Delay		116.9		64.1			19.7		18.9	
Approach LOS		F		E			B		B	

Intersection Summary

Cycle Length: 150

Actuated Cycle Length: 150

Offset: 24 (16%), Referenced to phase 2:SBT and 6:NBTL, Start of Yellow

Natural Cycle: 100

Control Type: Actuated-Coordinated

Maximum v/c Ratio: 1.13

Intersection Signal Delay: 39.2

Intersection LOS: D

Intersection Capacity Utilization 80.4%

ICU Level of Service D

Analysis Period (min) 15

Splits and Phases: 104: Alton Road & Dade Boulevard

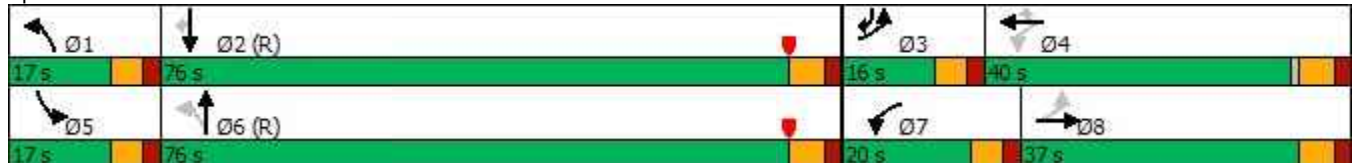

Queues

104: Alton Road & Dade Boulevard



Lane Group	EBL	EBT	WBL	WBT	WBR	NBL	NBT	SBL	SBT	SBR
Lane Group Flow (vph)	230	185	185	191	49	77	1113	53	811	104
v/c Ratio	1.13	0.65	0.80	0.53	0.19	0.20	0.59	0.54	0.42	0.11
Control Delay	151.6	73.7	77.1	67.5	1.7	9.3	20.5	86.9	16.4	3.5
Queue Delay	0.0	0.0	0.0	0.0	0.0	0.0	0.0	0.0	0.0	0.0
Total Delay	151.6	73.7	77.1	67.5	1.7	9.3	20.5	86.9	16.4	3.5
Queue Length 50th (ft)	~236	89	160	94	0	22	341	51	207	11
Queue Length 95th (ft)	#396	130	#249	133	0	44	474	98	283	33
Internal Link Dist (ft)		316		456			473		500	
Turn Bay Length (ft)	220		185		60	350		185		70
Base Capacity (vph)	204	643	233	735	404	421	1871	123	1939	947
Starvation Cap Reductn	0	0	0	0	0	0	0	0	0	0
Spillback Cap Reductn	0	0	0	0	0	0	0	0	0	0
Storage Cap Reductn	0	0	0	0	0	0	0	0	0	0
Reduced v/c Ratio	1.13	0.29	0.79	0.26	0.12	0.18	0.59	0.43	0.42	0.11

Intersection Summary

~ Volume exceeds capacity, queue is theoretically infinite.























Queue shown is maximum after two cycles.

95th percentile volume exceeds capacity, queue may be longer.

Queue shown is maximum after two cycles.

HCM 6th Signalized Intersection Summary

104: Alton Road & Dade Boulevard

												
Movement	EBL	EBT	EBR	WBL	WBT	WBR	NBL	NBT	NBR	SBL	SBT	SBR
Lane Configurations												
Traffic Volume (veh/h)	209	149	19	168	174	45	70	822	191	48	738	95
Future Volume (veh/h)	209	149	19	168	174	45	70	822	191	48	738	95
Initial Q (Qb), veh	0	0	0	0	0	0	0	0	0	0	0	0
Ped-Bike Adj(A_pbT)	0.99		1.00	0.97		1.00	1.00		0.98	1.00		0.98
Parking Bus, Adj	1.00	1.00	1.00	1.00	1.00	1.00	1.00	1.00	1.00	1.00	1.00	1.00
Work Zone On Approach		No			No			No			No	
Adj Sat Flow, veh/h/ln	1670	1670	1670	1670	1670	1670	1670	1670	1670	1670	1670	1670
Adj Flow Rate, veh/h	230	164	0	185	191	0	77	903	210	53	811	104
Peak Hour Factor	0.91	0.91	0.91	0.91	0.91	0.91	0.91	0.91	0.91	0.91	0.91	0.91
Percent Heavy Veh, %	3	3	3	3	3	3	3	3	3	3	3	3
Cap, veh/h	253	377		275	462		349	1496	348	66	1897	924
Arrive On Green	0.07	0.12	0.00	0.10	0.15	0.00	0.03	0.59	0.59	0.04	0.60	0.60
Sat Flow, veh/h	1590	3256	0	1590	3173	1415	1590	2543	591	1590	3173	1382
Grp Volume(v), veh/h	230	164	0	185	191	0	77	563	550	53	811	104
Grp Sat Flow(s),veh/h/ln	1590	1586	0	1590	1586	1415	1590	1586	1547	1590	1586	1382
Q Serve(g_s), s	10.3	7.2	0.0	14.3	8.2	0.0	2.9	34.0	34.0	5.0	20.7	4.1
Cycle Q Clear(g_c), s	10.3	7.2	0.0	14.3	8.2	0.0	2.9	34.0	34.0	5.0	20.7	4.1
Prop In Lane	1.00		0.00	1.00		1.00	1.00		0.38	1.00		1.00
Lane Grp Cap(c), veh/h	253	377		275	462		349	934	911	66	1897	924
V/C Ratio(X)	0.91	0.43		0.67	0.41		0.22	0.60	0.60	0.81	0.43	0.11
Avail Cap(c_a), veh/h	253	656		275	719		418	934	911	120	1897	924
HCM Platoon Ratio	1.00	1.00	1.00	1.00	1.00	1.00	1.00	1.00	1.00	1.00	1.00	1.00
Upstream Filter(I)	1.00	1.00	0.00	1.00	1.00	0.00	1.00	1.00	1.00	1.00	1.00	1.00
Uniform Delay (d), s/veh	61.3	61.4	0.0	52.9	58.3	0.0	12.8	19.7	19.7	71.3	16.3	9.0
Incr Delay (d2), s/veh	33.0	0.6	0.0	5.2	0.4	0.0	0.1	2.9	3.0	8.3	0.7	0.2
Initial Q Delay(d3),s/veh	0.0	0.0	0.0	0.0	0.0	0.0	0.0	0.0	0.0	0.0	0.0	0.0
%ile BackOfQ(50%),veh/ln	6.7	3.0	0.0	6.6	3.4	0.0	1.1	13.2	12.9	2.2	7.7	1.3
Unsig. Movement Delay, s/veh												
LnGrp Delay(d),s/veh	94.3	62.0	0.0	58.1	58.7	0.0	12.9	22.6	22.7	79.6	17.0	9.3
LnGrp LOS	F	E		E	E		B	C	C	E	B	A
Approach Vol, veh/h		394			376			1190			968	
Approach Delay, s/veh		80.8			58.4			22.0			19.6	
Approach LOS		F			E			C			B	
Timer - Assigned Phs	1	2	3	4	5	6	7	8				
Phs Duration (G+Y+Rc), s	10.5	95.7	16.0	27.8	11.9	94.3	20.0	23.8				
Change Period (Y+Rc), s	* 5.7	6.0	* 5.7	6.0	* 5.7	6.0	* 5.7	6.0				
Max Green Setting (Gmax), s	* 11	70.0	* 10	34.0	* 11	70.0	* 14	31.0				
Max Q Clear Time (g_c+I1), s	4.9	22.7	12.3	10.2	7.0	36.0	16.3	9.2				
Green Ext Time (p_c), s	0.0	2.4	0.0	0.9	0.0	2.9	0.0	0.8				
Intersection Summary												
HCM 6th Ctrl Delay			33.8									
HCM 6th LOS			C									
Notes												
* HCM 6th computational engine requires equal clearance times for the phases crossing the barrier.												
Unsignalized Delay for [EBR, WBR] is excluded from calculations of the approach delay and intersection delay.												

Timings

105: Dade Blvd & Michigan Ave



Lane Group	EBT	WBT	WBR	SEL	SER	Ø3
Lane Configurations	↑↑	↑↑	↑	↑↑	↑	
Traffic Volume (vph)	361	361	687	356	25	
Future Volume (vph)	361	361	687	356	25	
Turn Type	NA	NA	pm+ov	Prot	Perm	
Protected Phases	6	2	4	4		3
Permitted Phases			2		4	
Detector Phase	6	2	4	4	4	
Switch Phase						
Minimum Initial (s)	14.0	14.0	7.0	7.0	7.0	1.0
Minimum Split (s)	36.0	36.0	20.6	20.6	20.6	27.0
Total Split (s)	39.0	39.0	54.0	54.0	54.0	27.0
Total Split (%)	32.5%	32.5%	45.0%	45.0%	45.0%	23%
Yellow Time (s)	4.0	4.0	4.0	4.0	4.0	2.0
All-Red Time (s)	2.0	2.0	2.0	2.0	2.0	0.0
Lost Time Adjust (s)	0.0	0.0	0.0	0.0	0.0	
Total Lost Time (s)	6.0	6.0	6.0	6.0	6.0	
Lead/Lag			Lag	Lag	Lag	Lead
Lead-Lag Optimize?			Yes	Yes	Yes	Yes
Recall Mode	C-Max	C-Max	None	None	None	None
Act Effct Green (s)	85.4	85.4	120.0	22.6	22.6	
Actuated g/C Ratio	0.71	0.71	1.00	0.19	0.19	
v/c Ratio	0.16	0.16	0.48	0.61	0.09	
Control Delay	6.3	6.3	1.1	48.3	13.2	
Queue Delay	0.0	0.0	0.0	0.0	0.0	
Total Delay	6.3	6.3	1.1	48.3	13.2	
LOS	A	A	A	D	B	
Approach Delay	6.3	2.9		46.0		
Approach LOS	A	A		D		

Intersection Summary

Cycle Length: 120
 Actuated Cycle Length: 120
 Offset: 117 (98%), Referenced to phase 2:WBT and 6:EBT, Start of Yellow
 Natural Cycle: 85
 Control Type: Actuated-Coordinated
 Maximum v/c Ratio: 0.61
 Intersection Signal Delay: 12.7
 Intersection Capacity Utilization 47.5%
 Analysis Period (min) 15
 Intersection LOS: B
 ICU Level of Service A

Splits and Phases: 105: Dade Blvd & Michigan Ave

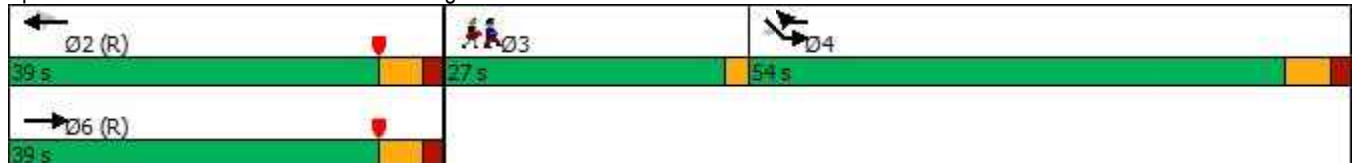

Queues

105: Dade Blvd & Michigan Ave



Lane Group	EBT	WBT	WBR	SEL	SER
Lane Group Flow (vph)	397	397	755	391	27
v/c Ratio	0.16	0.16	0.48	0.61	0.09
Control Delay	6.3	6.3	1.1	48.3	13.2
Queue Delay	0.0	0.0	0.0	0.0	0.0
Total Delay	6.3	6.3	1.1	48.3	13.2
Queue Length 50th (ft)	46	46	0	144	0
Queue Length 95th (ft)	80	80	0	181	24
Internal Link Dist (ft)	166	341		11	
Turn Bay Length (ft)			280		
Base Capacity (vph)	2495	2495	1568	1360	635
Starvation Cap Reductn	0	0	0	0	0
Spillback Cap Reductn	0	0	0	0	0
Storage Cap Reductn	0	0	0	0	0
Reduced v/c Ratio	0.16	0.16	0.48	0.29	0.04

Intersection Summary

HCM Signalized Intersection Capacity Analysis

105: Dade Blvd & Michigan Ave



Movement	EBL	EBT	WBT	WBR	SEL	SER
Lane Configurations		↑↑	↑↑	↑	↑↑	↑
Traffic Volume (vph)	0	361	361	687	356	25
Future Volume (vph)	0	361	361	687	356	25
Ideal Flow (vphpl)	1900	1900	1900	1900	1900	1900
Total Lost time (s)		6.0	6.0	6.0	6.0	6.0
Lane Util. Factor		0.95	0.95	1.00	0.97	1.00
Frbp, ped/bikes		1.00	1.00	1.00	1.00	0.99
Flpb, ped/bikes		1.00	1.00	1.00	1.00	1.00
Frt		1.00	1.00	0.85	1.00	0.85
Flt Protected		1.00	1.00	1.00	0.95	1.00
Satd. Flow (prot)		3505	3505	1568	3400	1547
Flt Permitted		1.00	1.00	1.00	0.95	1.00
Satd. Flow (perm)		3505	3505	1568	3400	1547
Peak-hour factor, PHF	0.91	0.91	0.91	0.91	0.91	0.91
Adj. Flow (vph)	0	397	397	755	391	27
RTOR Reduction (vph)	0	0	0	76	0	22
Lane Group Flow (vph)	0	397	397	680	391	5
Confl. Peds. (#/hr)	6					
Confl. Bikes (#/hr)						1
Turn Type		NA	NA	pm+ov	Prot	Perm
Protected Phases		6	2	4	4	
Permitted Phases				2		4
Actuated Green, G (s)		85.4	85.4	108.0	22.6	22.6
Effective Green, g (s)		85.4	85.4	108.0	22.6	22.6
Actuated g/C Ratio		0.71	0.71	0.90	0.19	0.19
Clearance Time (s)		6.0	6.0	6.0	6.0	6.0
Vehicle Extension (s)		1.0	1.0	3.5	3.5	3.5
Lane Grp Cap (vph)		2494	2494	1568	640	291
v/s Ratio Prot		0.11	0.11	c0.08	c0.12	
v/s Ratio Perm				0.35		0.00
v/c Ratio		0.16	0.16	0.43	0.61	0.02
Uniform Delay, d1		5.6	5.6	1.0	44.7	39.7
Progression Factor		1.00	1.00	1.00	1.00	1.00
Incremental Delay, d2		0.1	0.1	0.2	1.8	0.0
Delay (s)		5.8	5.8	1.2	46.5	39.7
Level of Service		A	A	A	D	D
Approach Delay (s)		5.8	2.8		46.0	
Approach LOS		A	A		D	
Intersection Summary						
HCM 2000 Control Delay			12.6		HCM 2000 Level of Service	B
HCM 2000 Volume to Capacity ratio			0.50			
Actuated Cycle Length (s)			120.0		Sum of lost time (s)	14.0
Intersection Capacity Utilization			47.5%		ICU Level of Service	A
Analysis Period (min)			15			
c Critical Lane Group						

HCM 6th Signalized Intersection Summary
105: Dade Blvd & Michigan Ave

HCM 6th Edition methodology does not support exclusive ped or hold phases.

Timings

101: Alton Rd & N Michigan Ave



Lane Group	SEL	SET	NWL	NWT	NWR	NEL	NET	SWL	SWT
Lane Configurations		↔		↔	↔	↔	↔	↔	↔
Traffic Volume (vph)	15	13	26	16	684	6	1284	314	1008
Future Volume (vph)	15	13	26	16	684	6	1284	314	1008
Turn Type	Perm	NA	Perm	NA	Free	Prot	NA	Prot	NA
Protected Phases		8		4		1	6	5	2
Permitted Phases	8		4		Free				
Detector Phase	8	8	4	4		1	6	5	2
Switch Phase									
Minimum Initial (s)	7.0	7.0	7.0	7.0		5.0	14.0	5.0	14.0
Minimum Split (s)	36.3	36.3	36.3	36.3		10.7	27.0	10.7	27.0
Total Split (s)	36.3	36.3	36.3	36.3		48.7	65.0	48.7	65.0
Total Split (%)	24.2%	24.2%	24.2%	24.2%		32.5%	43.3%	32.5%	43.3%
Yellow Time (s)	4.0	4.0	4.0	4.0		3.7	4.0	3.7	4.0
All-Red Time (s)	2.3	2.3	2.3	2.3		2.0	2.0	2.0	2.0
Lost Time Adjust (s)		-1.0		-1.0		-1.0	-1.0	1.0	1.0
Total Lost Time (s)		5.3		5.3		4.7	5.0	6.7	7.0
Lead/Lag						Lead	Lag	Lead	Lag
Lead-Lag Optimize?						Yes	Yes	Yes	Yes
Recall Mode	None	None	None	None		None	C-Max	None	C-Max
Act Effct Green (s)		10.9		10.9	150.0	10.2	101.4	23.3	127.6
Actuated g/C Ratio		0.07		0.07	1.00	0.07	0.68	0.16	0.85
v/c Ratio		0.30		0.44	0.50	0.06	0.63	0.68	0.39
Control Delay		69.1		79.5	1.3	72.2	15.1	67.0	4.5
Queue Delay		0.0		0.0	0.0	0.0	0.1	0.0	0.0
Total Delay		69.1		79.5	1.3	72.2	15.2	67.0	4.5
LOS		E		E	A	E	B	E	A
Approach Delay		69.1		5.8			15.4		19.3
Approach LOS		E		A			B		B

Intersection Summary

Cycle Length: 150
 Actuated Cycle Length: 150
 Offset: 118 (79%), Referenced to phase 2:SWT and 6:NET, Start of Yellow
 Natural Cycle: 100
 Control Type: Actuated-Coordinated
 Maximum v/c Ratio: 0.68
 Intersection Signal Delay: 15.3
 Intersection Capacity Utilization 75.0%
 Analysis Period (min) 15

Intersection LOS: B
 ICU Level of Service D

Splits and Phases: 101: Alton Rd & N Michigan Ave

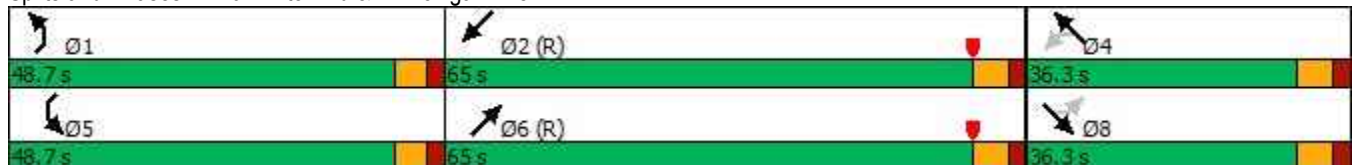

Queues

101: Alton Rd & N Michigan Ave



Lane Group	SET	NWT	NWR	NEL	NET	SWL	SWT
Lane Group Flow (vph)	30	43	705	6	1351	324	1045
v/c Ratio	0.30	0.44	0.50	0.06	0.63	0.68	0.39
Control Delay	69.1	79.5	1.3	72.2	15.1	67.0	4.5
Queue Delay	0.0	0.0	0.0	0.0	0.1	0.0	0.0
Total Delay	69.1	79.5	1.3	72.2	15.2	67.0	4.5
Queue Length 50th (ft)	27	41	0	6	465	157	96
Queue Length 95th (ft)	61	82	0	m11	621	201	256
Internal Link Dist (ft)	247	552			268		227
Turn Bay Length (ft)				100		265	
Base Capacity (vph)	279	279	1411	462	2151	856	2680
Starvation Cap Reductn	0	0	0	0	127	0	0
Spillback Cap Reductn	0	0	0	0	0	0	158
Storage Cap Reductn	0	0	0	0	0	0	0
Reduced v/c Ratio	0.11	0.15	0.50	0.01	0.67	0.38	0.41

Intersection Summary

m Volume for 95th percentile queue is metered by upstream signal.

HCM 6th Signalized Intersection Summary

101: Alton Rd & N Michigan Ave



Movement	SEL	SET	SER	NWL	NWT	NWR	NEL	NET	NER	SWL	SWT	SWR
Lane Configurations		↔			↔	↔	↔	↕↔		↕↔	↕↔	
Traffic Volume (veh/h)	15	13	2	26	16	684	6	1284	26	314	1008	6
Future Volume (veh/h)	15	13	2	26	16	684	6	1284	26	314	1008	6
Initial Q (Qb), veh	0	0	0	0	0	0	0	0	0	0	0	0
Ped-Bike Adj(A_pbT)	0.99		0.98	0.99		1.00	1.00		0.98	1.00		0.98
Parking Bus, Adj	1.00	1.00	1.00	1.00	1.00	1.00	1.00	1.00	1.00	1.00	1.00	1.00
Work Zone On Approach		No			No			No			No	
Adj Sat Flow, veh/h/ln	1670	1670	1670	1670	1670	1670	1670	1670	1670	1670	1670	1670
Adj Flow Rate, veh/h	15	13	2	27	16	0	6	1324	27	324	1039	6
Peak Hour Factor	0.97	0.97	0.97	0.97	0.97	0.97	0.97	0.97	0.97	0.97	0.97	0.97
Percent Heavy Veh, %	3	3	3	3	3	3	3	3	3	3	3	3
Cap, veh/h	81	59	7	98	48		22	2150	44	416	2578	15
Arrive On Green	0.08	0.08	0.07	0.08	0.08	0.00	0.03	1.00	1.00	0.13	0.80	0.80
Sat Flow, veh/h	599	785	99	786	640	1415	1590	3178	65	3086	3234	19
Grp Volume(v), veh/h	30	0	0	43	0	0	6	660	691	324	510	535
Grp Sat Flow(s),veh/h/ln	1483	0	0	1426	0	1415	1590	1586	1657	1543	1586	1666
Q Serve(g_s), s	0.0	0.0	0.0	1.4	0.0	0.0	0.6	0.0	0.0	15.2	14.4	14.4
Cycle Q Clear(g_c), s	2.6	0.0	0.0	4.0	0.0	0.0	0.6	0.0	0.0	15.2	14.4	14.4
Prop In Lane	0.50		0.07	0.63		1.00	1.00		0.04	1.00		0.01
Lane Grp Cap(c), veh/h	148	0	0	147	0		22	1073	1121	416	1265	1328
V/C Ratio(X)	0.20	0.00	0.00	0.29	0.00		0.27	0.62	0.62	0.78	0.40	0.40
Avail Cap(c_a), veh/h	332	0	0	326	0		467	1073	1121	864	1265	1328
HCM Platoon Ratio	1.00	1.00	1.00	1.00	1.00	1.00	2.00	2.00	2.00	1.00	1.00	1.00
Upstream Filter(I)	1.00	0.00	0.00	1.00	0.00	0.00	0.86	0.86	0.86	1.00	1.00	1.00
Uniform Delay (d), s/veh	65.3	0.0	0.0	65.9	0.0	0.0	72.1	0.0	0.0	62.7	4.5	4.5
Incr Delay (d2), s/veh	0.5	0.0	0.0	0.8	0.0	0.0	18.9	2.3	2.2	10.8	1.0	0.9
Initial Q Delay(d3),s/veh	0.0	0.0	0.0	0.0	0.0	0.0	0.0	0.0	0.0	0.0	0.0	0.0
%ile BackOfQ(50%),veh/ln	1.1	0.0	0.0	1.6	0.0	0.0	0.3	0.7	0.7	6.6	4.4	4.6
Unsig. Movement Delay, s/veh												
LnGrp Delay(d),s/veh	65.8	0.0	0.0	66.7	0.0	0.0	91.1	2.3	2.2	73.6	5.5	5.5
LnGrp LOS	E	A	A	E	A		F	A	A	E	A	A
Approach Vol, veh/h		30			43			1357			1369	
Approach Delay, s/veh		65.8			66.7			2.6			21.6	
Approach LOS		E			E			A			C	
Timer - Assigned Phs	1	2		4	5	6		8				
Phs Duration (G+Y+Rc), s	6.8	126.6		16.6	26.9	106.5		16.6				
Change Period (Y+Rc), s	* 5.7	6.0		* 6.3	* 5.7	6.0		* 6.3				
Max Green Setting (Gmax), s	* 43	59.0		* 30	* 43	59.0		* 30				
Max Q Clear Time (g_c+I1), s	2.6	16.4		6.0	17.2	2.0		4.6				
Green Ext Time (p_c), s	0.0	0.9		0.1	4.0	1.2		0.0				

Intersection Summary

HCM 6th Ctrl Delay	13.6
HCM 6th LOS	B

Notes

* HCM 6th computational engine requires equal clearance times for the phases crossing the barrier.

Unsignalized Delay for [NWR] is excluded from calculations of the approach delay and intersection delay.

Timings

102: Alton Rd & 20 St/Sunset Harbour Dr



Lane Group	EBL	EBT	EBR	WBT	NEL	NET	SWL	SWT	SWR
Lane Configurations									
Traffic Volume (vph)	194	8	34	0	92	1121	6	844	205
Future Volume (vph)	194	8	34	0	92	1121	6	844	205
Turn Type	Split	NA	Perm	NA	pm+pt	NA	Perm	NA	Perm
Protected Phases	3	3		4	1	6		2	
Permitted Phases			3		6		2		2
Detector Phase	3	3	3	4	1	6	2	2	2
Switch Phase									
Minimum Initial (s)	7.0	7.0	7.0	7.0	5.0	7.0	7.0	7.0	7.0
Minimum Split (s)	32.0	32.0	32.0	13.3	11.0	43.3	43.3	43.3	43.3
Total Split (s)	33.0	33.0	33.0	18.0	12.0	99.0	87.0	87.0	87.0
Total Split (%)	22.0%	22.0%	22.0%	12.0%	8.0%	66.0%	58.0%	58.0%	58.0%
Yellow Time (s)	4.0	4.0	4.0	4.0	4.0	4.0	4.0	4.0	4.0
All-Red Time (s)	2.0	2.0	2.0	2.3	2.0	3.3	3.3	3.3	3.3
Lost Time Adjust (s)	-1.3	0.0	-1.3	-1.3	1.0	1.0	-1.5	-1.5	-1.5
Total Lost Time (s)	4.7	6.0	4.7	5.0	7.0	8.3	5.8	5.8	5.8
Lead/Lag	Lead	Lead	Lead	Lag	Lead		Lag	Lag	Lag
Lead-Lag Optimize?	Yes	Yes	Yes	Yes	Yes		Yes	Yes	Yes
Recall Mode	None	None	None	None	None	C-Max	C-Max	C-Max	C-Max
Act Effct Green (s)	16.7	15.4	16.7	8.3	116.3	115.0	104.5	104.5	104.5
Actuated g/C Ratio	0.11	0.10	0.11	0.06	0.78	0.77	0.70	0.70	0.70
v/c Ratio	0.63	0.68	0.13	0.07	0.25	0.49	0.02	0.40	0.21
Control Delay	79.9	85.9	1.0	0.7	7.1	8.6	9.2	12.0	5.8
Queue Delay	0.0	0.0	0.0	0.1	0.0	0.1	0.0	0.3	0.5
Total Delay	79.9	85.9	1.0	0.8	7.1	8.8	9.2	12.3	6.3
LOS	E	F	A	A	A	A	A	B	A
Approach Delay		71.2		0.8		8.7		11.1	
Approach LOS		E		A		A		B	

Intersection Summary

Cycle Length: 150

Actuated Cycle Length: 150

Offset: 129 (86%), Referenced to phase 2:SWTL and 6:NETL, Start of Yellow

Natural Cycle: 100

Control Type: Actuated-Coordinated

Maximum v/c Ratio: 0.68

Intersection Signal Delay: 15.5

Intersection LOS: B

Intersection Capacity Utilization 70.1%

ICU Level of Service C

Analysis Period (min) 15

Splits and Phases: 102: Alton Rd & 20 St/Sunset Harbour Dr

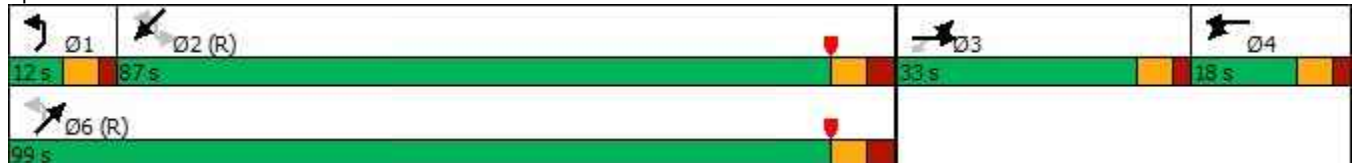

Queues

102: Alton Rd & 20 St/Sunset Harbour Dr























Lane Group	EBL	EBT	EBR	WBT	NEL	NET	SWL	SWT	SWR
Lane Group Flow (vph)	105	105	35	14	96	1173	6	879	214
v/c Ratio	0.63	0.68	0.13	0.07	0.25	0.49	0.02	0.40	0.21
Control Delay	79.9	85.9	1.0	0.7	7.1	8.6	9.2	12.0	5.8
Queue Delay	0.0	0.0	0.0	0.1	0.0	0.1	0.0	0.3	0.5
Total Delay	79.9	85.9	1.0	0.8	7.1	8.8	9.2	12.3	6.3
Queue Length 50th (ft)	105	106	0	0	16	162	2	188	42
Queue Length 95th (ft)	168	170	0	0	51	352	m0	348	127
Internal Link Dist (ft)		202		173		325		268	
Turn Bay Length (ft)					270		110		120
Base Capacity (vph)	282	271	364	236	390	2416	278	2198	1005
Starvation Cap Reductn	0	0	0	0	0	0	0	656	467
Spillback Cap Reductn	0	0	0	45	0	375	0	0	0
Storage Cap Reductn	0	0	0	0	0	0	0	0	0
Reduced v/c Ratio	0.37	0.39	0.10	0.07	0.25	0.57	0.02	0.57	0.40

Intersection Summary

m Volume for 95th percentile queue is metered by upstream signal.

HCM Signalized Intersection Capacity Analysis

102: Alton Rd & 20 St/Sunset Harbour Dr

												
Movement	EBL	EBT	EBR	WBL	WBT	WBR	NEL	NET	NER	SWL	SWT	SWR
Lane Configurations												
Traffic Volume (vph)	194	8	34	0	0	13	92	1121	5	6	844	205
Future Volume (vph)	194	8	34	0	0	13	92	1121	5	6	844	205
Ideal Flow (vphpl)	1900	1900	1900	1900	1900	1900	1900	1900	1900	1900	1900	1900
Total Lost time (s)	4.7	6.0	4.7		5.0		7.0	8.3		5.8	5.8	5.8
Lane Util. Factor	0.95	0.95	1.00		1.00		1.00	0.95		1.00	0.95	1.00
Frpb, ped/bikes	1.00	1.00	1.00		1.00		1.00	1.00		1.00	1.00	0.98
Flpb, ped/bikes	1.00	1.00	1.00		1.00		1.00	1.00		1.00	1.00	1.00
Frt	1.00	1.00	0.85		0.86		1.00	1.00		1.00	1.00	0.85
Flt Protected	0.95	0.96	1.00		1.00		0.95	1.00		0.95	1.00	1.00
Satd. Flow (prot)	1498	1508	1411		1436		1577	3152		1577	3154	1382
Flt Permitted	0.95	0.96	1.00		1.00		0.27	1.00		0.24	1.00	1.00
Satd. Flow (perm)	1498	1508	1411		1436		443	3152		400	3154	1382
Peak-hour factor, PHF	0.96	0.96	0.96	0.96	0.96	0.96	0.96	0.96	0.96	0.96	0.96	0.96
Adj. Flow (vph)	202	8	35	0	0	14	96	1168	5	6	879	214
RTOR Reduction (vph)	0	0	31	0	14	0	0	0	0	0	0	46
Lane Group Flow (vph)	105	105	4	0	0	0	96	1173	0	6	879	168
Confl. Bikes (#/hr)												1
Turn Type	Split	NA	Perm		NA		pm+pt	NA		Perm	NA	Perm
Protected Phases	3	3		4	4		1	6			2	
Permitted Phases			3				6			2		2
Actuated Green, G (s)	15.4	15.4	15.4		2.8		112.2	112.2		99.2	99.2	99.2
Effective Green, g (s)	16.7	15.4	16.7		4.1		111.2	111.2		100.7	100.7	100.7
Actuated g/C Ratio	0.11	0.10	0.11		0.03		0.74	0.74		0.67	0.67	0.67
Clearance Time (s)	6.0	6.0	6.0		6.3		6.0	7.3		7.3	7.3	7.3
Vehicle Extension (s)	2.5	2.5	2.5		2.5		2.0	1.0		1.0	1.0	1.0
Lane Grp Cap (vph)	166	154	157		39		373	2336		268	2117	927
v/s Ratio Prot	c0.07	0.07			c0.00		0.01	c0.37			0.28	
v/s Ratio Perm			0.00				0.18			0.01		0.12
v/c Ratio	0.63	0.68	0.02		0.01		0.26	0.50		0.02	0.42	0.18
Uniform Delay, d1	63.7	64.9	59.4		71.0		6.7	8.0		8.2	11.2	9.2
Progression Factor	1.00	1.00	1.00		1.00		1.00	1.00		0.78	1.01	1.28
Incremental Delay, d2	6.7	10.8	0.0		0.1		0.1	0.8		0.1	0.6	0.4
Delay (s)	70.4	75.7	59.4		71.0		6.8	8.8		6.5	11.9	12.3
Level of Service	E	E	E		E		A	A		A	B	B
Approach Delay (s)		71.1			71.0			8.6			12.0	
Approach LOS		E			E			A			B	
Intersection Summary												
HCM 2000 Control Delay			16.2				HCM 2000 Level of Service				B	
HCM 2000 Volume to Capacity ratio			0.53									
Actuated Cycle Length (s)			150.0				Sum of lost time (s)			23.8		
Intersection Capacity Utilization			70.1%				ICU Level of Service			C		
Analysis Period (min)			15									
c	Critical Lane Group											

HCM 6th Signalized Intersection Summary
102: Alton Rd & 20 St/Sunset Harbour Dr

HCM 6th Edition methodology expects strict NEMA phasing.

HCM 6th TWSC
103: Alton Rd & 19 St

Intersection						
Int Delay, s/veh	0.2					
Movement	WBL	WBR	NBT	NBR	SBL	SBT
Lane Configurations		↑	↑↑			↑↑
Traffic Vol, veh/h	0	34	1185	38	0	883
Future Vol, veh/h	0	34	1185	38	0	883
Conflicting Peds, #/hr	0	0	0	0	0	0
Sign Control	Stop	Stop	Free	Free	Free	Free
RT Channelized	-	None	-	None	-	None
Storage Length	-	0	-	-	-	-
Veh in Median Storage, #	0	-	0	-	-	0
Grade, %	0	-	0	-	-	0
Peak Hour Factor	92	92	92	92	92	92
Heavy Vehicles, %	3	3	3	3	3	3
Mvmt Flow	0	37	1288	41	0	960

Major/Minor	Minor1	Major1	Major2		
Conflicting Flow All	-	665	0	0	-
Stage 1	-	-	-	-	-
Stage 2	-	-	-	-	-
Critical Hdwy	-	4.5	-	-	-
Critical Hdwy Stg 1	-	-	-	-	-
Critical Hdwy Stg 2	-	-	-	-	-
Follow-up Hdwy	-	3	-	-	-
Pot Cap-1 Maneuver	0	681	-	-	0
Stage 1	0	-	-	-	0
Stage 2	0	-	-	-	0
Platoon blocked, %			-	-	-
Mov Cap-1 Maneuver	-	681	-	-	-
Mov Cap-2 Maneuver	-	-	-	-	-
Stage 1	-	-	-	-	-
Stage 2	-	-	-	-	-

Approach	WB	NB	SB
HCM Control Delay, s	10.6	0	0
HCM LOS	B		

Minor Lane/Major Mvmt	NBT	NBRWBLn1	SBT
Capacity (veh/h)	-	-	681
HCM Lane V/C Ratio	-	-	0.054
HCM Control Delay (s)	-	-	10.6
HCM Lane LOS	-	-	B
HCM 95th %tile Q(veh)	-	-	0.2

Timings

104: Alton Road & Dade Boulevard

Lane Group	EBL	EBT	WBL	WBT	WBR	NBL	NBT	SBL	SBT	SBR
Lane Configurations										
Traffic Volume (vph)	228	163	183	190	49	77	899	55	813	103
Future Volume (vph)	228	163	183	190	49	77	899	55	813	103
Turn Type	pm+pt	NA	pm+pt	NA	Perm	pm+pt	NA	Prot	NA	pm+ov
Protected Phases	3	8	7	4		1	6	5	2	3
Permitted Phases	8		4		4	6				2
Detector Phase	3	8	7	4	4	1	6	5	2	3
Switch Phase										
Minimum Initial (s)	5.0	7.0	5.0	7.0	7.0	5.0	4.0	5.0	4.0	5.0
Minimum Split (s)	11.0	37.0	11.0	37.0	37.0	11.0	29.0	11.0	29.0	11.0
Total Split (s)	16.0	37.0	20.0	40.0	40.0	17.0	76.0	17.0	76.0	16.0
Total Split (%)	10.7%	24.7%	13.3%	26.7%	26.7%	11.3%	50.7%	11.3%	50.7%	10.7%
Yellow Time (s)	3.7	4.0	3.7	4.0	4.0	3.7	4.0	3.7	4.0	3.7
All-Red Time (s)	2.0	2.0	2.0	2.0	2.0	2.0	2.0	2.0	2.0	2.0
Lost Time Adjust (s)	0.0	0.0	0.0	0.0	0.0	0.0	0.0	0.0	0.0	0.0
Total Lost Time (s)	5.7	6.0	5.7	6.0	6.0	5.7	6.0	5.7	6.0	5.7
Lead/Lag	Lead	Lag	Lead	Lag	Lag	Lead	Lag	Lead	Lag	Lead
Lead-Lag Optimize?	Yes	Yes	Yes	Yes	Yes	Yes	Yes	Yes	Yes	Yes
Recall Mode	None	None	None	None	None	None	C-Max	None	C-Max	None
Act Effct Green (s)	24.9	14.3	32.8	18.2	18.2	96.7	90.2	10.1	90.9	101.5
Actuated g/C Ratio	0.17	0.10	0.22	0.12	0.12	0.64	0.60	0.07	0.61	0.68
v/c Ratio	1.21	0.67	0.87	0.55	0.21	0.25	0.66	0.57	0.47	0.12
Control Delay	176.1	73.7	84.7	67.0	1.8	10.2	23.3	87.1	17.9	4.0
Queue Delay	0.0	0.0	0.0	0.0	0.0	0.0	0.0	0.0	0.0	0.0
Total Delay	176.1	73.7	84.7	67.0	1.8	10.2	23.3	87.1	17.9	4.0
LOS	F	E	F	E	A	B	C	F	B	A
Approach Delay		130.5		67.1			22.4		20.3	
Approach LOS		F		E			C		C	

Intersection Summary

Cycle Length: 150

Actuated Cycle Length: 150

Offset: 24 (16%), Referenced to phase 2:SBT and 6:NBTL, Start of Yellow

Natural Cycle: 100

Control Type: Actuated-Coordinated

Maximum v/c Ratio: 1.21

Intersection Signal Delay: 42.9

Intersection LOS: D

Intersection Capacity Utilization 84.3%

ICU Level of Service E

Analysis Period (min) 15

Splits and Phases: 104: Alton Road & Dade Boulevard

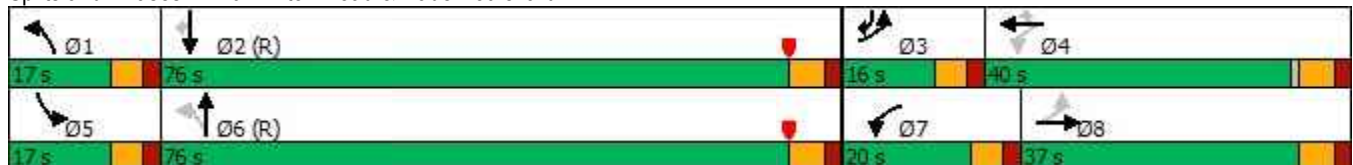

Queues

104: Alton Road & Dade Boulevard



Lane Group	EBL	EBT	WBL	WBT	WBR	NBL	NBT	SBL	SBT	SBR
Lane Group Flow (vph)	251	202	201	209	54	85	1217	60	893	113
v/c Ratio	1.21	0.67	0.87	0.55	0.21	0.25	0.66	0.57	0.47	0.12
Control Delay	176.1	73.7	84.7	67.0	1.8	10.2	23.3	87.1	17.9	4.0
Queue Delay	0.0	0.0	0.0	0.0	0.0	0.0	0.0	0.0	0.0	0.0
Total Delay	176.1	73.7	84.7	67.0	1.8	10.2	23.3	87.1	17.9	4.0
Queue Length 50th (ft)	~277	98	175	102	0	25	406	58	242	13
Queue Length 95th (ft)	#450	139	#290	143	0	49	564	106	330	38
Internal Link Dist (ft)		316		456			473		500	
Turn Bay Length (ft)	220		185		60	350		185		70
Base Capacity (vph)	208	643	233	735	404	382	1839	127	1910	935
Starvation Cap Reductn	0	0	0	0	0	0	0	0	0	0
Spillback Cap Reductn	0	0	0	0	0	0	0	0	0	0
Storage Cap Reductn	0	0	0	0	0	0	0	0	0	0
Reduced v/c Ratio	1.21	0.31	0.86	0.28	0.13	0.22	0.66	0.47	0.47	0.12

Intersection Summary

~ Volume exceeds capacity, queue is theoretically infinite.























Queue shown is maximum after two cycles.

95th percentile volume exceeds capacity, queue may be longer.

Queue shown is maximum after two cycles.

HCM 6th Signalized Intersection Summary

104: Alton Road & Dade Boulevard

												
Movement	EBL	EBT	EBR	WBL	WBT	WBR	NBL	NBT	NBR	SBL	SBT	SBR
Lane Configurations												
Traffic Volume (veh/h)	228	163	21	183	190	49	77	899	208	55	813	103
Future Volume (veh/h)	228	163	21	183	190	49	77	899	208	55	813	103
Initial Q (Qb), veh	0	0	0	0	0	0	0	0	0	0	0	0
Ped-Bike Adj(A_pbT)	0.99		1.00	0.98		1.00	1.00		0.98	1.00		0.98
Parking Bus, Adj	1.00	1.00	1.00	1.00	1.00	1.00	1.00	1.00	1.00	1.00	1.00	1.00
Work Zone On Approach		No			No			No			No	
Adj Sat Flow, veh/h/ln	1670	1670	1670	1670	1670	1670	1670	1670	1670	1670	1670	1670
Adj Flow Rate, veh/h	251	179	0	201	209	0	85	988	229	60	893	113
Peak Hour Factor	0.91	0.91	0.91	0.91	0.91	0.91	0.91	0.91	0.91	0.91	0.91	0.91
Percent Heavy Veh, %	3	3	3	3	3	3	3	3	3	3	3	3
Cap, veh/h	249	387		273	472		319	1477	341	74	1880	916
Arrive On Green	0.07	0.12	0.00	0.10	0.15	0.00	0.03	0.58	0.58	0.05	0.59	0.59
Sat Flow, veh/h	1590	3256	0	1590	3173	1415	1590	2546	588	1590	3173	1382
Grp Volume(v), veh/h	251	179	0	201	209	0	85	615	602	60	893	113
Grp Sat Flow(s),veh/h/ln	1590	1586	0	1590	1586	1415	1590	1586	1548	1590	1586	1382
Q Serve(g_s), s	10.3	7.9	0.0	14.3	9.0	0.0	3.3	39.8	40.1	5.6	23.9	4.5
Cycle Q Clear(g_c), s	10.3	7.9	0.0	14.3	9.0	0.0	3.3	39.8	40.1	5.6	23.9	4.5
Prop In Lane	1.00		0.00	1.00		1.00	1.00		0.38	1.00		1.00
Lane Grp Cap(c), veh/h	249	387		273	472		319	920	898	74	1880	916
V/C Ratio(X)	1.01	0.46		0.74	0.44		0.27	0.67	0.67	0.81	0.48	0.12
Avail Cap(c_a), veh/h	249	656		273	719		384	920	898	120	1880	916
HCM Platoon Ratio	1.00	1.00	1.00	1.00	1.00	1.00	1.00	1.00	1.00	1.00	1.00	1.00
Upstream Filter(I)	1.00	1.00	0.00	1.00	1.00	0.00	1.00	1.00	1.00	1.00	1.00	1.00
Uniform Delay (d), s/veh	62.3	61.3	0.0	53.9	58.2	0.0	13.7	21.6	21.7	70.8	17.3	9.4
Incr Delay (d2), s/veh	59.0	0.6	0.0	8.9	0.5	0.0	0.2	3.8	4.0	7.7	0.9	0.3
Initial Q Delay(d3),s/veh	0.0	0.0	0.0	0.0	0.0	0.0	0.0	0.0	0.0	0.0	0.0	0.0
%ile BackOfQ(50%),veh/ln	9.2	3.2	0.0	1.8	3.7	0.0	1.2	15.6	15.4	2.5	9.0	1.5
Unsig. Movement Delay, s/veh												
LnGrp Delay(d),s/veh	121.3	61.9	0.0	62.8	58.7	0.0	13.9	25.4	25.6	78.5	18.2	9.7
LnGrp LOS	F	E		E	E		B	C	C	E	B	A
Approach Vol, veh/h		430			410			1302			1066	
Approach Delay, s/veh		96.6			60.7			24.8			20.7	
Approach LOS		F			E			C			C	
Timer - Assigned Phs	1	2	3	4	5	6	7	8				
Phs Duration (G+Y+Rc), s	10.9	94.9	16.0	28.3	12.7	93.0	20.0	24.3				
Change Period (Y+Rc), s	* 5.7	6.0	* 5.7	6.0	* 5.7	6.0	* 5.7	6.0				
Max Green Setting (Gmax), s	* 11	70.0	* 10	34.0	* 11	70.0	* 14	31.0				
Max Q Clear Time (g_c+I1), s	5.3	25.9	12.3	11.0	7.6	42.1	16.3	9.9				
Green Ext Time (p_c), s	0.0	2.7	0.0	1.0	0.0	3.2	0.0	0.8				
Intersection Summary												
HCM 6th Ctrl Delay				37.6								
HCM 6th LOS				D								
Notes												
* HCM 6th computational engine requires equal clearance times for the phases crossing the barrier.												
Unsignalized Delay for [EBR, WBR] is excluded from calculations of the approach delay and intersection delay.												

Timings

105: Dade Blvd & Michigan Ave



Lane Group	EBT	WBT	WBR	SEL	SER	Ø3
Lane Configurations	↑↑	↑↑	↑	↑↑	↑	
Traffic Volume (vph)	394	394	749	388	27	
Future Volume (vph)	394	394	749	388	27	
Turn Type	NA	NA	pm+ov	Prot	Perm	
Protected Phases	6	2	4	4		3
Permitted Phases			2		4	
Detector Phase	6	2	4	4	4	
Switch Phase						
Minimum Initial (s)	14.0	14.0	7.0	7.0	7.0	1.0
Minimum Split (s)	36.0	36.0	20.6	20.6	20.6	27.0
Total Split (s)	39.0	39.0	54.0	54.0	54.0	27.0
Total Split (%)	32.5%	32.5%	45.0%	45.0%	45.0%	23%
Yellow Time (s)	4.0	4.0	4.0	4.0	4.0	2.0
All-Red Time (s)	2.0	2.0	2.0	2.0	2.0	0.0
Lost Time Adjust (s)	0.0	0.0	0.0	0.0	0.0	
Total Lost Time (s)	6.0	6.0	6.0	6.0	6.0	
Lead/Lag			Lag	Lag	Lag	Lead
Lead-Lag Optimize?			Yes	Yes	Yes	Yes
Recall Mode	C-Max	C-Max	None	None	None	None
Act Effect Green (s)	83.3	83.3	120.0	24.7	24.7	
Actuated g/C Ratio	0.69	0.69	1.00	0.21	0.21	
v/c Ratio	0.18	0.18	0.52	0.61	0.09	
Control Delay	7.2	7.2	1.3	46.5	12.1	
Queue Delay	0.0	0.0	0.0	0.0	0.0	
Total Delay	7.2	7.2	1.3	46.5	12.1	
LOS	A	A	A	D	B	
Approach Delay	7.2	3.3		44.3		
Approach LOS	A	A		D		

Intersection Summary

Cycle Length: 120
 Actuated Cycle Length: 120
 Offset: 117 (98%), Referenced to phase 2:WBT and 6:EBT, Start of Yellow
 Natural Cycle: 85
 Control Type: Actuated-Coordinated
 Maximum v/c Ratio: 0.61
 Intersection Signal Delay: 12.8
 Intersection Capacity Utilization 51.4%
 Analysis Period (min) 15

Intersection LOS: B
 ICU Level of Service A

Splits and Phases: 105: Dade Blvd & Michigan Ave

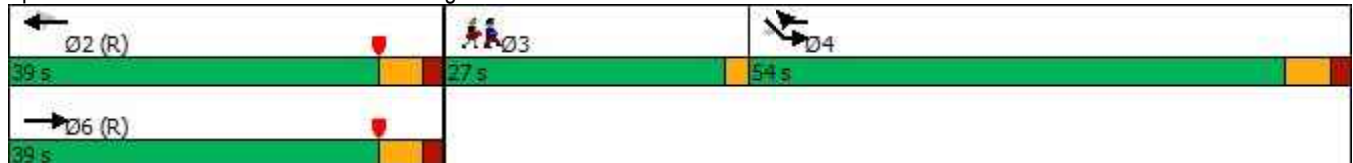

Queues

105: Dade Blvd & Michigan Ave



Lane Group	EBT	WBT	WBR	SEL	SER
Lane Group Flow (vph)	433	433	823	426	30
v/c Ratio	0.18	0.18	0.52	0.61	0.09
Control Delay	7.2	7.2	1.3	46.5	12.1
Queue Delay	0.0	0.0	0.0	0.0	0.0
Total Delay	7.2	7.2	1.3	46.5	12.1
Queue Length 50th (ft)	55	55	0	156	0
Queue Length 95th (ft)	92	92	0	193	24
Internal Link Dist (ft)	166	341		11	
Turn Bay Length (ft)			280		
Base Capacity (vph)	2434	2434	1568	1360	637
Starvation Cap Reductn	0	0	0	0	0
Spillback Cap Reductn	0	0	0	0	0
Storage Cap Reductn	0	0	0	0	0
Reduced v/c Ratio	0.18	0.18	0.52	0.31	0.05
Intersection Summary					

HCM Signalized Intersection Capacity Analysis

105: Dade Blvd & Michigan Ave



Movement	EBL	EBT	WBT	WBR	SEL	SER
Lane Configurations		↑↑	↑↑	↗	↖↗	↗
Traffic Volume (vph)	0	394	394	749	388	27
Future Volume (vph)	0	394	394	749	388	27
Ideal Flow (vphpl)	1900	1900	1900	1900	1900	1900
Total Lost time (s)		6.0	6.0	6.0	6.0	6.0
Lane Util. Factor		0.95	0.95	1.00	0.97	1.00
Frbp, ped/bikes		1.00	1.00	1.00	1.00	0.99
Flpb, ped/bikes		1.00	1.00	1.00	1.00	1.00
Frt		1.00	1.00	0.85	1.00	0.85
Flt Protected		1.00	1.00	1.00	0.95	1.00
Satd. Flow (prot)		3505	3505	1568	3400	1547
Flt Permitted		1.00	1.00	1.00	0.95	1.00
Satd. Flow (perm)		3505	3505	1568	3400	1547
Peak-hour factor, PHF	0.91	0.91	0.91	0.91	0.91	0.91
Adj. Flow (vph)	0	433	433	823	426	30
RTOR Reduction (vph)	0	0	0	82	0	24
Lane Group Flow (vph)	0	433	433	741	426	6
Confl. Peds. (#/hr)	6					
Confl. Bikes (#/hr)						1
Turn Type		NA	NA	pm+ov	Prot	Perm
Protected Phases		6	2	4	4	
Permitted Phases				2		4
Actuated Green, G (s)		83.3	83.3	108.0	24.7	24.7
Effective Green, g (s)		83.3	83.3	108.0	24.7	24.7
Actuated g/C Ratio		0.69	0.69	0.90	0.21	0.21
Clearance Time (s)		6.0	6.0	6.0	6.0	6.0
Vehicle Extension (s)		1.0	1.0	3.5	3.5	3.5
Lane Grp Cap (vph)		2433	2433	1568	699	318
v/s Ratio Prot		0.12	0.12	c0.10	c0.13	
v/s Ratio Perm				0.38		0.00
v/c Ratio		0.18	0.18	0.47	0.61	0.02
Uniform Delay, d1		6.4	6.4	1.0	43.3	38.0
Progression Factor		1.00	1.00	1.00	1.00	1.00
Incremental Delay, d2		0.2	0.2	0.3	1.6	0.0
Delay (s)		6.6	6.6	1.3	44.9	38.0
Level of Service		A	A	A	D	D
Approach Delay (s)		6.6	3.1		44.4	
Approach LOS		A	A		D	
Intersection Summary						
HCM 2000 Control Delay			12.6		HCM 2000 Level of Service	B
HCM 2000 Volume to Capacity ratio			0.54			
Actuated Cycle Length (s)			120.0		Sum of lost time (s)	14.0
Intersection Capacity Utilization			51.4%		ICU Level of Service	A
Analysis Period (min)			15			
c Critical Lane Group						

HCM 6th Signalized Intersection Summary
105: Dade Blvd & Michigan Ave

HCM 6th Edition methodology does not support exclusive ped or hold phases.

Timings

101: Alton Rd & N Michigan Ave



Lane Group	SEL	SET	NWL	NWT	NWR	NEL	NET	SWL	SWT
Lane Configurations		↕		↕	↕	↕	↕↔	↕↔	↕↔
Traffic Volume (vph)	15	20	26	16	684	13	1304	334	1008
Future Volume (vph)	15	20	26	16	684	13	1304	334	1008
Turn Type	Perm	NA	Perm	NA	Free	Prot	NA	Prot	NA
Protected Phases		8		4		1	6	5	2
Permitted Phases	8		4		Free				
Detector Phase	8	8	4	4		1	6	5	2
Switch Phase									
Minimum Initial (s)	7.0	7.0	7.0	7.0		5.0	14.0	5.0	14.0
Minimum Split (s)	36.3	36.3	36.3	36.3		10.7	27.0	10.7	27.0
Total Split (s)	36.3	36.3	36.3	36.3		48.7	65.0	48.7	65.0
Total Split (%)	24.2%	24.2%	24.2%	24.2%		32.5%	43.3%	32.5%	43.3%
Yellow Time (s)	4.0	4.0	4.0	4.0		3.7	4.0	3.7	4.0
All-Red Time (s)	2.3	2.3	2.3	2.3		2.0	2.0	2.0	2.0
Lost Time Adjust (s)		-1.0		-1.0		-1.0	-1.0	1.0	1.0
Total Lost Time (s)		5.3		5.3		4.7	5.0	6.7	7.0
Lead/Lag						Lead	Lag	Lead	Lag
Lead-Lag Optimize?						Yes	Yes	Yes	Yes
Recall Mode	None	None	None	None		None	C-Max	None	C-Max
Act Effct Green (s)		10.9		10.9	150.0	10.8	100.5	24.2	124.1
Actuated g/C Ratio		0.07		0.07	1.00	0.07	0.67	0.16	0.83
v/c Ratio		0.37		0.42	0.50	0.12	0.65	0.70	0.40
Control Delay		72.3		78.2	1.3	70.3	15.9	66.8	5.9
Queue Delay		0.0		0.0	0.0	0.0	0.1	0.0	0.0
Total Delay		72.3		78.2	1.3	70.3	16.0	66.8	5.9
LOS		E		E	A	E	B	E	A
Approach Delay		72.3		5.7			16.5		21.0
Approach LOS		E		A			B		C

Intersection Summary

Cycle Length: 150
 Actuated Cycle Length: 150
 Offset: 118 (79%), Referenced to phase 2:SWT and 6:NET, Start of Yellow
 Natural Cycle: 100
 Control Type: Actuated-Coordinated
 Maximum v/c Ratio: 0.70
 Intersection Signal Delay: 16.6
 Intersection Capacity Utilization 76.9%
 Analysis Period (min) 15
 Intersection LOS: B
 ICU Level of Service D

Splits and Phases: 101: Alton Rd & N Michigan Ave

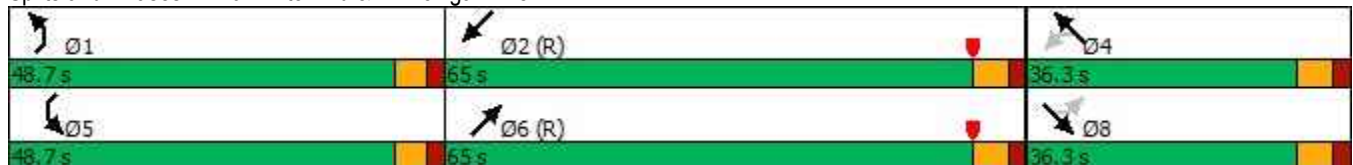

Queues

101: Alton Rd & N Michigan Ave



Lane Group	SET	NWT	NWR	NEL	NET	SWL	SWT
Lane Group Flow (vph)	38	43	705	13	1377	344	1045
v/c Ratio	0.37	0.42	0.50	0.12	0.65	0.70	0.40
Control Delay	72.3	78.2	1.3	70.3	15.9	66.8	5.9
Queue Delay	0.0	0.0	0.0	0.0	0.1	0.0	0.0
Total Delay	72.3	78.2	1.3	70.3	16.0	66.8	5.9
Queue Length 50th (ft)	34	41	0	12	484	166	96
Queue Length 95th (ft)	73	82	0	m25	646	211	265
Internal Link Dist (ft)	247	552			268		227
Turn Bay Length (ft)				100		265	
Base Capacity (vph)	291	289	1411	462	2132	856	2606
Starvation Cap Reductn	0	0	0	0	107	0	0
Spillback Cap Reductn	0	0	0	0	0	0	151
Storage Cap Reductn	0	0	0	0	0	0	0
Reduced v/c Ratio	0.13	0.15	0.50	0.03	0.68	0.40	0.43

Intersection Summary

m Volume for 95th percentile queue is metered by upstream signal.

HCM 6th Signalized Intersection Summary

101: Alton Rd & N Michigan Ave



Movement	SEL	SET	SER	NWL	NWT	NWR	NEL	NET	NER	SWL	SWT	SWR
Lane Configurations		↔			↔	↔	↔	↕↔		↕↔	↕↔	
Traffic Volume (veh/h)	15	20	2	26	16	684	13	1304	32	334	1008	6
Future Volume (veh/h)	15	20	2	26	16	684	13	1304	32	334	1008	6
Initial Q (Qb), veh	0	0	0	0	0	0	0	0	0	0	0	0
Ped-Bike Adj(A_pbT)	0.99		0.98	0.99		1.00	1.00		0.98	1.00		0.98
Parking Bus, Adj	1.00	1.00	1.00	1.00	1.00	1.00	1.00	1.00	1.00	1.00	1.00	1.00
Work Zone On Approach		No			No			No			No	
Adj Sat Flow, veh/h/ln	1670	1670	1670	1670	1670	1670	1670	1670	1670	1670	1670	1670
Adj Flow Rate, veh/h	15	21	2	27	16	0	13	1344	33	344	1039	6
Peak Hour Factor	0.97	0.97	0.97	0.97	0.97	0.97	0.97	0.97	0.97	0.97	0.97	0.97
Percent Heavy Veh, %	3	3	3	3	3	3	3	3	3	3	3	3
Cap, veh/h	66	76	6	99	49		33	2114	52	439	2555	15
Arrive On Green	0.08	0.08	0.07	0.08	0.08	0.00	0.04	1.00	1.00	0.14	0.79	0.80
Sat Flow, veh/h	433	1004	80	793	643	1415	1590	3163	78	3086	3234	19
Grp Volume(v), veh/h	38	0	0	43	0	0	13	674	703	344	510	535
Grp Sat Flow(s),veh/h/ln	1517	0	0	1436	0	1415	1590	1586	1654	1543	1586	1666
Q Serve(g_s), s	0.0	0.0	0.0	0.6	0.0	0.0	1.2	0.0	0.0	16.1	14.9	14.9
Cycle Q Clear(g_c), s	3.3	0.0	0.0	3.9	0.0	0.0	1.2	0.0	0.0	16.1	14.9	14.9
Prop In Lane	0.39		0.05	0.63		1.00	1.00		0.05	1.00		0.01
Lane Grp Cap(c), veh/h	149	0	0	148	0		33	1060	1106	439	1253	1316
V/C Ratio(X)	0.26	0.00	0.00	0.29	0.00		0.40	0.64	0.64	0.78	0.41	0.41
Avail Cap(c_a), veh/h	338	0	0	326	0		467	1060	1106	864	1253	1316
HCM Platoon Ratio	1.00	1.00	1.00	1.00	1.00	1.00	2.00	2.00	2.00	1.00	1.00	1.00
Upstream Filter(I)	1.00	0.00	0.00	1.00	0.00	0.00	0.85	0.85	0.85	1.00	1.00	1.00
Uniform Delay (d), s/veh	65.6	0.0	0.0	65.8	0.0	0.0	71.0	0.0	0.0	62.1	4.9	4.9
Incr Delay (d2), s/veh	0.7	0.0	0.0	0.8	0.0	0.0	22.3	2.5	2.4	10.5	1.0	0.9
Initial Q Delay(d3),s/veh	0.0	0.0	0.0	0.0	0.0	0.0	0.0	0.0	0.0	0.0	0.0	0.0
%ile BackOfQ(50%),veh/ln	1.4	0.0	0.0	1.6	0.0	0.0	0.7	0.7	0.7	7.0	4.6	4.8
Unsig. Movement Delay, s/veh												
LnGrp Delay(d),s/veh	66.2	0.0	0.0	66.6	0.0	0.0	93.3	2.5	2.4	72.6	5.8	5.8
LnGrp LOS	E	A	A	E	A		F	A	A	E	A	A
Approach Vol, veh/h		38			43			1390			1389	
Approach Delay, s/veh		66.2			66.6			3.3			22.4	
Approach LOS		E			E			A			C	
Timer - Assigned Phs	1	2		4	5	6		8				
Phs Duration (G+Y+Rc), s	7.8	125.5		16.7	28.0	105.3		16.7				
Change Period (Y+Rc), s	* 5.7	6.0		* 6.3	* 5.7	6.0		* 6.3				
Max Green Setting (Gmax), s	* 43	59.0		* 30	* 43	59.0		* 30				
Max Q Clear Time (g_c+I1), s	3.2	16.9		5.9	18.1	2.0		5.3				
Green Ext Time (p_c), s	0.1	0.9		0.1	4.2	1.2		0.1				

Intersection Summary

HCM 6th Ctrl Delay	14.3
HCM 6th LOS	B

Notes

* HCM 6th computational engine requires equal clearance times for the phases crossing the barrier.

Unsignalized Delay for [NWR] is excluded from calculations of the approach delay and intersection delay.

Timings

102: Alton Rd & 20 St/Sunset Harbour Dr



Lane Group	EBL	EBT	EBR	WBT	NEL	NET	SWL	SWT	SWR
Lane Configurations									
Traffic Volume (vph)	194	8	34	0	99	1148	6	844	211
Future Volume (vph)	194	8	34	0	99	1148	6	844	211
Turn Type	Split	NA	Perm	NA	pm+pt	NA	Perm	NA	Perm
Protected Phases	3	3		4	1	6		2	
Permitted Phases			3		6		2		2
Detector Phase	3	3	3	4	1	6	2	2	2
Switch Phase									
Minimum Initial (s)	7.0	7.0	7.0	7.0	5.0	7.0	7.0	7.0	7.0
Minimum Split (s)	32.0	32.0	32.0	13.3	11.0	43.3	43.3	43.3	43.3
Total Split (s)	33.0	33.0	33.0	18.0	12.0	99.0	87.0	87.0	87.0
Total Split (%)	22.0%	22.0%	22.0%	12.0%	8.0%	66.0%	58.0%	58.0%	58.0%
Yellow Time (s)	4.0	4.0	4.0	4.0	4.0	4.0	4.0	4.0	4.0
All-Red Time (s)	2.0	2.0	2.0	2.3	2.0	3.3	3.3	3.3	3.3
Lost Time Adjust (s)	-1.3	0.0	-1.3	-1.3	1.0	1.0	-1.5	-1.5	-1.5
Total Lost Time (s)	4.7	6.0	4.7	5.0	7.0	8.3	5.8	5.8	5.8
Lead/Lag	Lead	Lead	Lead	Lag	Lead		Lag	Lag	Lag
Lead-Lag Optimize?	Yes	Yes	Yes	Yes	Yes		Yes	Yes	Yes
Recall Mode	None	None	None	None	None	C-Max	C-Max	C-Max	C-Max
Act Effct Green (s)	16.7	15.4	16.7	8.3	116.3	115.0	104.4	104.4	104.4
Actuated g/C Ratio	0.11	0.10	0.11	0.06	0.78	0.77	0.70	0.70	0.70
v/c Ratio	0.63	0.68	0.13	0.07	0.26	0.50	0.02	0.40	0.22
Control Delay	79.9	85.9	1.0	0.8	7.3	8.8	7.5	10.9	5.0
Queue Delay	0.0	0.0	0.0	0.0	0.0	0.2	0.0	0.3	0.5
Total Delay	79.9	85.9	1.0	0.8	7.3	9.0	7.5	11.2	5.5
LOS	E	F	A	A	A	A	A	B	A
Approach Delay		71.2		0.8		8.8		10.0	
Approach LOS		E		A		A		B	

Intersection Summary

Cycle Length: 150

Actuated Cycle Length: 150

Offset: 129 (86%), Referenced to phase 2:SWTL and 6:NETL, Start of Yellow

Natural Cycle: 100

Control Type: Actuated-Coordinated

Maximum v/c Ratio: 0.68

Intersection Signal Delay: 15.0

Intersection LOS: B

Intersection Capacity Utilization 70.9%

ICU Level of Service C

Analysis Period (min) 15

Splits and Phases: 102: Alton Rd & 20 St/Sunset Harbour Dr

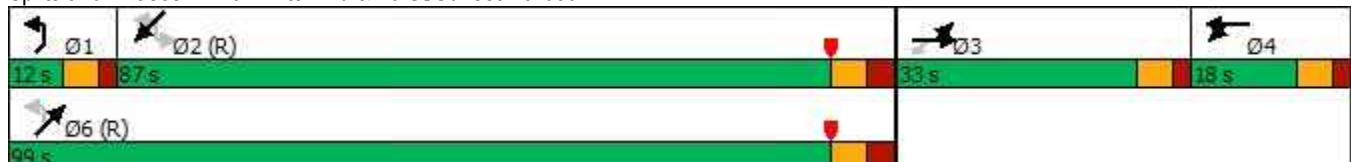

Queues

102: Alton Rd & 20 St/Sunset Harbour Dr



Lane Group	EBL	EBT	EBR	WBT	NEL	NET	SWL	SWT	SWR
Lane Group Flow (vph)	105	105	35	14	103	1201	6	879	220
v/c Ratio	0.63	0.68	0.13	0.07	0.26	0.50	0.02	0.40	0.22
Control Delay	79.9	85.9	1.0	0.8	7.3	8.8	7.5	10.9	5.0
Queue Delay	0.0	0.0	0.0	0.0	0.0	0.2	0.0	0.3	0.5
Total Delay	79.9	85.9	1.0	0.8	7.3	9.0	7.5	11.2	5.5
Queue Length 50th (ft)	105	106	0	0	17	168	2	188	44
Queue Length 95th (ft)	168	170	0	0	54	365	m0	350	133
Internal Link Dist (ft)		202		173		325		268	
Turn Bay Length (ft)					270		110		120
Base Capacity (vph)	282	271	364	233	391	2416	269	2194	1005
Starvation Cap Reductn	0	0	0	0	0	0	0	653	460
Spillback Cap Reductn	0	0	0	0	0	398	0	0	0
Storage Cap Reductn	0	0	0	0	0	0	0	0	0
Reduced v/c Ratio	0.37	0.39	0.10	0.06	0.26	0.60	0.02	0.57	0.40

Intersection Summary

m Volume for 95th percentile queue is metered by upstream signal.

HCM Signalized Intersection Capacity Analysis

102: Alton Rd & 20 St/Sunset Harbour Dr



Movement	EBL	EBT	EBR	WBL	WBT	WBR	NEL	NET	NER	SWL	SWT	SWR
Lane Configurations												
Traffic Volume (vph)	194	8	34	0	0	13	99	1148	5	6	844	211
Future Volume (vph)	194	8	34	0	0	13	99	1148	5	6	844	211
Ideal Flow (vphpl)	1900	1900	1900	1900	1900	1900	1900	1900	1900	1900	1900	1900
Total Lost time (s)	4.7	6.0	4.7		5.0		7.0	8.3		5.8	5.8	5.8
Lane Util. Factor	0.95	0.95	1.00		1.00		1.00	0.95		1.00	0.95	1.00
Frpb, ped/bikes	1.00	1.00	1.00		1.00		1.00	1.00		1.00	1.00	0.98
Flpb, ped/bikes	1.00	1.00	1.00		1.00		1.00	1.00		1.00	1.00	1.00
Frt	1.00	1.00	0.85		0.86		1.00	1.00		1.00	1.00	0.85
Flt Protected	0.95	0.96	1.00		1.00		0.95	1.00		0.95	1.00	1.00
Satd. Flow (prot)	1498	1508	1411		1436		1577	3152		1577	3154	1382
Flt Permitted	0.95	0.96	1.00		1.00		0.27	1.00		0.23	1.00	1.00
Satd. Flow (perm)	1498	1508	1411		1436		443	3152		389	3154	1382
Peak-hour factor, PHF	0.96	0.96	0.96	0.96	0.96	0.96	0.96	0.96	0.96	0.96	0.96	0.96
Adj. Flow (vph)	202	8	35	0	0	14	103	1196	5	6	879	220
RTOR Reduction (vph)	0	0	31	0	14	0	0	0	0	0	0	47
Lane Group Flow (vph)	105	105	4	0	0	0	103	1201	0	6	879	173
Confl. Bikes (#/hr)												1
Turn Type	Split	NA	Perm		NA		pm+pt	NA		Perm	NA	Perm
Protected Phases	3	3		4	4		1	6			2	
Permitted Phases			3				6			2		2
Actuated Green, G (s)	15.4	15.4	15.4		2.8		112.2	112.2		99.1	99.1	99.1
Effective Green, g (s)	16.7	15.4	16.7		4.1		111.2	111.2		100.6	100.6	100.6
Actuated g/C Ratio	0.11	0.10	0.11		0.03		0.74	0.74		0.67	0.67	0.67
Clearance Time (s)	6.0	6.0	6.0		6.3		6.0	7.3		7.3	7.3	7.3
Vehicle Extension (s)	2.5	2.5	2.5		2.5		2.0	1.0		1.0	1.0	1.0
Lane Grp Cap (vph)	166	154	157		39		374	2336		260	2115	926
v/s Ratio Prot	c0.07	0.07			c0.00		0.01	c0.38			0.28	
v/s Ratio Perm			0.00				0.19			0.02		0.12
v/c Ratio	0.63	0.68	0.02		0.01		0.28	0.51		0.02	0.42	0.19
Uniform Delay, d1	63.7	64.9	59.4		71.0		6.7	8.1		8.3	11.3	9.3
Progression Factor	1.00	1.00	1.00		1.00		1.00	1.00		0.62	0.90	1.10
Incremental Delay, d2	6.7	10.8	0.0		0.1		0.1	0.8		0.2	0.6	0.4
Delay (s)	70.4	75.7	59.4		71.0		6.9	8.9		5.3	10.8	10.6
Level of Service	E	E	E		E		A	A		A	B	B
Approach Delay (s)		71.1			71.0			8.8			10.7	
Approach LOS		E			E			A			B	
Intersection Summary												
HCM 2000 Control Delay			15.6				HCM 2000 Level of Service				B	
HCM 2000 Volume to Capacity ratio			0.54									
Actuated Cycle Length (s)			150.0				Sum of lost time (s)			23.8		
Intersection Capacity Utilization			70.9%				ICU Level of Service			C		
Analysis Period (min)			15									
c Critical Lane Group												

HCM 6th Signalized Intersection Summary
102: Alton Rd & 20 St/Sunset Harbour Dr

HCM 6th Edition methodology expects strict NEMA phasing.

HCM 6th TWSC
103: Alton Rd & 19 St

Intersection						
Int Delay, s/veh	0.3					
Movement	WBL	WBR	NBT	NBR	SBL	SBT
Lane Configurations		↑	↑↑			↑↑
Traffic Vol, veh/h	0	68	1185	113	0	883
Future Vol, veh/h	0	68	1185	113	0	883
Conflicting Peds, #/hr	0	0	0	0	0	0
Sign Control	Stop	Stop	Free	Free	Free	Free
RT Channelized	-	None	-	None	-	None
Storage Length	-	0	-	-	-	-
Veh in Median Storage, #	0	-	0	-	-	0
Grade, %	0	-	0	-	-	0
Peak Hour Factor	92	92	92	92	92	92
Heavy Vehicles, %	3	3	3	3	3	3
Mvmt Flow	0	74	1288	123	0	960

Major/Minor	Minor1	Major1	Major2		
Conflicting Flow All	-	706	0	0	-
Stage 1	-	-	-	-	-
Stage 2	-	-	-	-	-
Critical Hdwy	-	4.5	-	-	-
Critical Hdwy Stg 1	-	-	-	-	-
Critical Hdwy Stg 2	-	-	-	-	-
Follow-up Hdwy	-	3	-	-	-
Pot Cap-1 Maneuver	0	657	-	-	0
Stage 1	0	-	-	-	0
Stage 2	0	-	-	-	0
Platoon blocked, %			-	-	-
Mov Cap-1 Maneuver	-	657	-	-	-
Mov Cap-2 Maneuver	-	-	-	-	-
Stage 1	-	-	-	-	-
Stage 2	-	-	-	-	-

Approach	WB	NB	SB
HCM Control Delay, s	11.2	0	0
HCM LOS	B		

Minor Lane/Major Mvmt	NBT	NBRWBLn1	SBT
Capacity (veh/h)	-	-	657
HCM Lane V/C Ratio	-	-	0.113
HCM Control Delay (s)	-	-	11.2
HCM Lane LOS	-	-	B
HCM 95th %tile Q(veh)	-	-	0.4

Timings

104: Alton Road & Dade Boulevard



Lane Group	EBL	EBT	WBL	WBT	WBR	NBL	NBT	SBL	SBT	SBR
Lane Configurations										
Traffic Volume (vph)	256	163	213	217	73	77	930	55	813	103
Future Volume (vph)	256	163	213	217	73	77	930	55	813	103
Turn Type	pm+pt	NA	pm+pt	NA	Perm	pm+pt	NA	Prot	NA	pm+ov
Protected Phases	3	8	7	4		1	6	5	2	3
Permitted Phases	8		4		4	6				2
Detector Phase	3	8	7	4	4	1	6	5	2	3
Switch Phase										
Minimum Initial (s)	5.0	7.0	5.0	7.0	7.0	5.0	4.0	5.0	4.0	5.0
Minimum Split (s)	11.0	37.0	11.0	37.0	37.0	11.0	29.0	11.0	29.0	11.0
Total Split (s)	16.0	37.0	20.0	40.0	40.0	17.0	76.0	17.0	76.0	16.0
Total Split (%)	10.7%	24.7%	13.3%	26.7%	26.7%	11.3%	50.7%	11.3%	50.7%	10.7%
Yellow Time (s)	3.7	4.0	3.7	4.0	4.0	3.7	4.0	3.7	4.0	3.7
All-Red Time (s)	2.0	2.0	2.0	2.0	2.0	2.0	2.0	2.0	2.0	2.0
Lost Time Adjust (s)	0.0	0.0	0.0	0.0	0.0	0.0	0.0	0.0	0.0	0.0
Total Lost Time (s)	5.7	6.0	5.7	6.0	6.0	5.7	6.0	5.7	6.0	5.7
Lead/Lag	Lead	Lag	Lead	Lag	Lag	Lead	Lag	Lead	Lag	Lead
Lead-Lag Optimize?	Yes	Yes	Yes	Yes	Yes	Yes	Yes	Yes	Yes	Yes
Recall Mode	None	None	None	None	None	None	C-Max	None	C-Max	None
Act Effct Green (s)	24.9	14.3	32.9	18.3	18.3	96.6	90.1	10.1	90.8	101.4
Actuated g/C Ratio	0.17	0.10	0.22	0.12	0.12	0.64	0.60	0.07	0.61	0.68
v/c Ratio	1.37	0.67	1.01	0.62	0.31	0.25	0.68	0.57	0.47	0.12
Control Delay	235.1	73.7	114.0	69.4	7.3	10.2	23.9	87.1	17.9	4.0
Queue Delay	0.0	0.0	0.0	0.0	0.0	0.0	0.0	0.0	0.0	0.0
Total Delay	235.1	73.7	114.0	69.4	7.3	10.2	23.9	87.1	17.9	4.0
LOS	F	E	F	E	A	B	C	F	B	A
Approach Delay		167.6		79.3			23.0		20.3	
Approach LOS		F		E			C		C	

Intersection Summary

Cycle Length: 150

Actuated Cycle Length: 150

Offset: 24 (16%), Referenced to phase 2:SBT and 6:NBTL, Start of Yellow

Natural Cycle: 100

Control Type: Actuated-Coordinated

Maximum v/c Ratio: 1.37

Intersection Signal Delay: 51.6

Intersection LOS: D

Intersection Capacity Utilization 87.1%

ICU Level of Service E

Analysis Period (min) 15

Splits and Phases: 104: Alton Road & Dade Boulevard

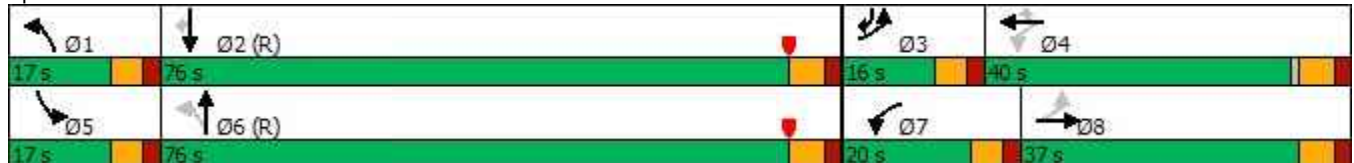

Queues

104: Alton Road & Dade Boulevard



Lane Group	EBL	EBT	WBL	WBT	WBR	NBL	NBT	SBL	SBT	SBR
Lane Group Flow (vph)	281	202	234	238	80	85	1251	60	893	113
v/c Ratio	1.37	0.67	1.01	0.62	0.31	0.25	0.68	0.57	0.47	0.12
Control Delay	235.1	73.7	114.0	69.4	7.3	10.2	23.9	87.1	17.9	4.0
Queue Delay	0.0	0.0	0.0	0.0	0.0	0.0	0.0	0.0	0.0	0.0
Total Delay	235.1	73.7	114.0	69.4	7.3	10.2	23.9	87.1	17.9	4.0
Queue Length 50th (ft)	~261	98	~211	118	0	25	426	58	242	13
Queue Length 95th (ft)	#520	139	#291	161	28	49	591	106	330	38
Internal Link Dist (ft)		316		456			473		500	
Turn Bay Length (ft)	220		185		60	350		185		70
Base Capacity (vph)	205	643	232	735	404	382	1839	127	1908	934
Starvation Cap Reductn	0	0	0	0	0	0	0	0	0	0
Spillback Cap Reductn	0	0	0	0	0	0	0	0	0	0
Storage Cap Reductn	0	0	0	0	0	0	0	0	0	0
Reduced v/c Ratio	1.37	0.31	1.01	0.32	0.20	0.22	0.68	0.47	0.47	0.12

Intersection Summary

~ Volume exceeds capacity, queue is theoretically infinite.























Queue shown is maximum after two cycles.

95th percentile volume exceeds capacity, queue may be longer.

Queue shown is maximum after two cycles.

HCM 6th Signalized Intersection Summary

104: Alton Road & Dade Boulevard

												
Movement	EBL	EBT	EBR	WBL	WBT	WBR	NBL	NBT	NBR	SBL	SBT	SBR
Lane Configurations												
Traffic Volume (veh/h)	256	163	21	213	217	73	77	930	208	55	813	103
Future Volume (veh/h)	256	163	21	213	217	73	77	930	208	55	813	103
Initial Q (Qb), veh	0	0	0	0	0	0	0	0	0	0	0	0
Ped-Bike Adj(A_pbT)	0.99		1.00	0.98		1.00	1.00		0.98	1.00		0.98
Parking Bus, Adj	1.00	1.00	1.00	1.00	1.00	1.00	1.00	1.00	1.00	1.00	1.00	1.00
Work Zone On Approach		No			No			No			No	
Adj Sat Flow, veh/h/ln	1670	1670	1670	1670	1670	1670	1670	1670	1670	1670	1670	1670
Adj Flow Rate, veh/h	281	179	0	234	238	0	85	1022	229	60	893	113
Peak Hour Factor	0.91	0.91	0.91	0.91	0.91	0.91	0.91	0.91	0.91	0.91	0.91	0.91
Percent Heavy Veh, %	3	3	3	3	3	3	3	3	3	3	3	3
Cap, veh/h	238	387		273	472		319	1488	332	74	1880	916
Arrive On Green	0.07	0.12	0.00	0.10	0.15	0.00	0.03	0.58	0.58	0.05	0.59	0.59
Sat Flow, veh/h	1590	3256	0	1590	3173	1415	1590	2565	573	1590	3173	1382
Grp Volume(v), veh/h	281	179	0	234	238	0	85	631	620	60	893	113
Grp Sat Flow(s),veh/h/ln	1590	1586	0	1590	1586	1415	1590	1586	1551	1590	1586	1382
Q Serve(g_s), s	10.3	7.9	0.0	14.3	10.4	0.0	3.3	41.6	42.0	5.6	23.9	4.5
Cycle Q Clear(g_c), s	10.3	7.9	0.0	14.3	10.4	0.0	3.3	41.6	42.0	5.6	23.9	4.5
Prop In Lane	1.00		0.00	1.00		1.00	1.00		0.37	1.00		1.00
Lane Grp Cap(c), veh/h	238	387		273	472		319	920	900	74	1880	916
V/C Ratio(X)	1.18	0.46		0.86	0.50		0.27	0.69	0.69	0.81	0.48	0.12
Avail Cap(c_a), veh/h	238	656		273	719		384	920	900	120	1880	916
HCM Platoon Ratio	1.00	1.00	1.00	1.00	1.00	1.00	1.00	1.00	1.00	1.00	1.00	1.00
Upstream Filter(I)	1.00	1.00	0.00	1.00	1.00	0.00	1.00	1.00	1.00	1.00	1.00	1.00
Uniform Delay (d), s/veh	62.2	61.3	0.0	56.7	58.8	0.0	13.7	22.0	22.0	70.8	17.3	9.4
Incr Delay (d2), s/veh	116.7	0.6	0.0	22.0	0.6	0.0	0.2	4.1	4.3	7.7	0.9	0.3
Initial Q Delay(d3),s/veh	0.0	0.0	0.0	0.0	0.0	0.0	0.0	0.0	0.0	0.0	0.0	0.0
%ile BackOfQ(50%),veh/ln	12.4	3.2	0.0	4.3	4.2	0.0	1.2	16.4	16.2	2.5	9.0	1.5
Unsig. Movement Delay, s/veh												
LnGrp Delay(d),s/veh	178.9	61.9	0.0	78.7	59.4	0.0	13.9	26.1	26.3	78.5	18.2	9.7
LnGrp LOS	F	E		E	E		B	C	C	E	B	A
Approach Vol, veh/h		460			472			1336			1066	
Approach Delay, s/veh		133.4			69.0			25.4			20.7	
Approach LOS		F			E			C			C	
Timer - Assigned Phs	1	2	3	4	5	6	7	8				
Phs Duration (G+Y+Rc), s	10.9	94.9	16.0	28.3	12.7	93.0	20.0	24.3				
Change Period (Y+Rc), s	* 5.7	6.0	* 5.7	6.0	* 5.7	6.0	* 5.7	6.0				
Max Green Setting (Gmax), s	* 11	70.0	* 10	34.0	* 11	70.0	* 14	31.0				
Max Q Clear Time (g_c+I1), s	5.3	25.9	12.3	12.4	7.6	44.0	16.3	9.9				
Green Ext Time (p_c), s	0.0	2.7	0.0	1.2	0.0	3.4	0.0	0.8				
Intersection Summary												
HCM 6th Ctrl Delay			45.0									
HCM 6th LOS			D									
Notes												
* HCM 6th computational engine requires equal clearance times for the phases crossing the barrier.												
Unsignalized Delay for [EBR, WBR] is excluded from calculations of the approach delay and intersection delay.												

Timings

105: Dade Blvd & Michigan Ave



Lane Group	EBT	WBT	WBR	SEL	SER	Ø3
Lane Configurations	↑↑	↑↑	↔	↔	↔	
Traffic Volume (vph)	394	418	749	412	84	
Future Volume (vph)	394	418	749	412	84	
Turn Type	NA	NA	pm+ov	Prot	Perm	
Protected Phases	6	2	4	4		3
Permitted Phases			2		4	
Detector Phase	6	2	4	4	4	
Switch Phase						
Minimum Initial (s)	14.0	14.0	7.0	7.0	7.0	1.0
Minimum Split (s)	36.0	36.0	20.6	20.6	20.6	27.0
Total Split (s)	39.0	39.0	54.0	54.0	54.0	27.0
Total Split (%)	32.5%	32.5%	45.0%	45.0%	45.0%	23%
Yellow Time (s)	4.0	4.0	4.0	4.0	4.0	2.0
All-Red Time (s)	2.0	2.0	2.0	2.0	2.0	0.0
Lost Time Adjust (s)	0.0	0.0	0.0	0.0	0.0	
Total Lost Time (s)	6.0	6.0	6.0	6.0	6.0	
Lead/Lag			Lag	Lag	Lag	Lead
Lead-Lag Optimize?			Yes	Yes	Yes	Yes
Recall Mode	C-Max	C-Max	None	None	None	None
Act Effect Green (s)	81.8	81.8	120.0	26.2	26.2	
Actuated g/C Ratio	0.68	0.68	1.00	0.22	0.22	
v/c Ratio	0.18	0.19	0.52	0.61	0.22	
Control Delay	7.9	7.9	1.3	45.2	8.0	
Queue Delay	0.0	0.0	0.0	0.0	0.0	
Total Delay	7.9	7.9	1.3	45.2	8.0	
LOS	A	A	A	D	A	
Approach Delay	7.9	3.6		38.9		
Approach LOS	A	A		D		

Intersection Summary

Cycle Length: 120

Actuated Cycle Length: 120

Offset: 117 (98%), Referenced to phase 2:WBT and 6:EBT, Start of Yellow

Natural Cycle: 85

Control Type: Actuated-Coordinated

Maximum v/c Ratio: 0.61

Intersection Signal Delay: 13.0

Intersection LOS: B

Intersection Capacity Utilization 51.4%

ICU Level of Service A

Analysis Period (min) 15

Splits and Phases: 105: Dade Blvd & Michigan Ave

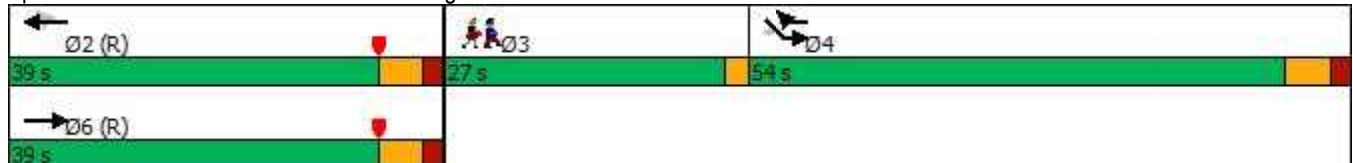

Queues

105: Dade Blvd & Michigan Ave



Lane Group	EBT	WBT	WBR	SEL	SER
Lane Group Flow (vph)	433	459	823	453	92
v/c Ratio	0.18	0.19	0.52	0.61	0.22
Control Delay	7.9	7.9	1.3	45.2	8.0
Queue Delay	0.0	0.0	0.0	0.0	0.0
Total Delay	7.9	7.9	1.3	45.2	8.0
Queue Length 50th (ft)	58	62	0	164	0
Queue Length 95th (ft)	98	104	0	199	39
Internal Link Dist (ft)	166	341		11	
Turn Bay Length (ft)			280		
Base Capacity (vph)	2388	2388	1568	1360	674
Starvation Cap Reductn	0	0	0	0	0
Spillback Cap Reductn	0	0	0	0	0
Storage Cap Reductn	0	0	0	0	0
Reduced v/c Ratio	0.18	0.19	0.52	0.33	0.14

Intersection Summary

HCM Signalized Intersection Capacity Analysis

105: Dade Blvd & Michigan Ave



Movement	EBL	EBT	WBT	WBR	SEL	SER
Lane Configurations		↑↑	↑↑	↑	↑↑	↑
Traffic Volume (vph)	0	394	418	749	412	84
Future Volume (vph)	0	394	418	749	412	84
Ideal Flow (vphpl)	1900	1900	1900	1900	1900	1900
Total Lost time (s)		6.0	6.0	6.0	6.0	6.0
Lane Util. Factor		0.95	0.95	1.00	0.97	1.00
Frbp, ped/bikes		1.00	1.00	1.00	1.00	0.99
Flpb, ped/bikes		1.00	1.00	1.00	1.00	1.00
Frt		1.00	1.00	0.85	1.00	0.85
Flt Protected		1.00	1.00	1.00	0.95	1.00
Satd. Flow (prot)		3505	3505	1568	3400	1548
Flt Permitted		1.00	1.00	1.00	0.95	1.00
Satd. Flow (perm)		3505	3505	1568	3400	1548
Peak-hour factor, PHF	0.91	0.91	0.91	0.91	0.91	0.91
Adj. Flow (vph)	0	433	459	823	453	92
RTOR Reduction (vph)	0	0	0	82	0	72
Lane Group Flow (vph)	0	433	459	741	453	20
Confl. Peds. (#/hr)	6					
Confl. Bikes (#/hr)						1
Turn Type		NA	NA	pm+ov	Prot	Perm
Protected Phases		6	2	4	4	
Permitted Phases				2		4
Actuated Green, G (s)		81.8	81.8	108.0	26.2	26.2
Effective Green, g (s)		81.8	81.8	108.0	26.2	26.2
Actuated g/C Ratio		0.68	0.68	0.90	0.22	0.22
Clearance Time (s)		6.0	6.0	6.0	6.0	6.0
Vehicle Extension (s)		1.0	1.0	3.5	3.5	3.5
Lane Grp Cap (vph)		2389	2389	1568	742	337
v/s Ratio Prot		0.12	0.13	c0.10	c0.13	
v/s Ratio Perm				0.37		0.01
v/c Ratio		0.18	0.19	0.47	0.61	0.06
Uniform Delay, d1		6.9	7.0	1.0	42.3	37.1
Progression Factor		1.00	1.00	1.00	1.00	1.00
Incremental Delay, d2		0.2	0.2	0.3	1.6	0.1
Delay (s)		7.1	7.2	1.3	43.9	37.2
Level of Service		A	A	A	D	D
Approach Delay (s)		7.1	3.4		42.7	
Approach LOS		A	A		D	
Intersection Summary						
HCM 2000 Control Delay			13.6		HCM 2000 Level of Service	B
HCM 2000 Volume to Capacity ratio			0.54			
Actuated Cycle Length (s)			120.0		Sum of lost time (s)	14.0
Intersection Capacity Utilization			51.4%		ICU Level of Service	A
Analysis Period (min)			15			
c Critical Lane Group						

HCM 6th Signalized Intersection Summary
105: Dade Blvd & Michigan Ave

HCM 6th Edition methodology does not support exclusive ped or hold phases.

HCM 6th TWSC
201: 19 St & Driveway

Intersection						
Int Delay, s/veh	6.7					
Movement	EBL	EBT	WBT	WBR	SBL	SBR
Lane Configurations		4	1		4	
Traffic Vol, veh/h	124	38	34	54	129	55
Future Vol, veh/h	124	38	34	54	129	55
Conflicting Peds, #/hr	0	0	0	0	0	0
Sign Control	Free	Free	Free	Free	Stop	Stop
RT Channelized	-	None	-	None	-	None
Storage Length	-	-	-	-	0	-
Veh in Median Storage, #	-	0	0	-	0	-
Grade, %	-	0	0	-	0	-
Peak Hour Factor	92	92	92	92	92	92
Heavy Vehicles, %	3	3	3	3	3	3
Mvmt Flow	135	41	37	59	140	60

Major/Minor	Major1	Major2	Minor2		
Conflicting Flow All	96	0	-	0	378
Stage 1	-	-	-	-	67
Stage 2	-	-	-	-	311
Critical Hdwy	4.13	-	-	-	5
Critical Hdwy Stg 1	-	-	-	-	5
Critical Hdwy Stg 2	-	-	-	-	5
Follow-up Hdwy	2.227	-	-	-	3
Pot Cap-1 Maneuver	1491	-	-	-	828
Stage 1	-	-	-	-	1124
Stage 2	-	-	-	-	884
Platoon blocked, %		-	-	-	
Mov Cap-1 Maneuver	1491	-	-	-	751
Mov Cap-2 Maneuver	-	-	-	-	751
Stage 1	-	-	-	-	1019
Stage 2	-	-	-	-	884

Approach	EB	WB	SB
HCM Control Delay, s	5.9	0	10.7
HCM LOS			B

Minor Lane/Major Mvmt	EBL	EBT	WBT	WBR	SBLn1
Capacity (veh/h)	1491	-	-	-	835
HCM Lane V/C Ratio	0.09	-	-	-	0.24
HCM Control Delay (s)	7.7	0	-	-	10.7
HCM Lane LOS	A	A	-	-	B
HCM 95th %tile Q(veh)	0.3	-	-	-	0.9

Timings

104: Alton Road & Dade Boulevard

09/18/2023



Lane Group	EBL	EBT	WBL	WBT	WBR	NBL	NBT	SBL	SBT	SBR
Lane Configurations										
Traffic Volume (vph)	256	163	213	217	73	77	930	55	813	103
Future Volume (vph)	256	163	213	217	73	77	930	55	813	103
Turn Type	pm+pt	NA	pm+pt	NA	Perm	pm+pt	NA	Prot	NA	pm+ov
Protected Phases	3	8	7	4		1	6	5	2	3
Permitted Phases	8		4		4	6				2
Detector Phase	3	8	7	4	4	1	6	5	2	3
Switch Phase										
Minimum Initial (s)	5.0	7.0	5.0	7.0	7.0	5.0	4.0	5.0	4.0	5.0
Minimum Split (s)	11.0	37.0	11.0	37.0	37.0	11.0	29.0	11.0	29.0	11.0
Total Split (s)	23.0	38.0	22.0	37.0	37.0	12.0	76.0	14.0	78.0	23.0
Total Split (%)	15.3%	25.3%	14.7%	24.7%	24.7%	8.0%	50.7%	9.3%	52.0%	15.3%
Yellow Time (s)	3.7	4.0	3.7	4.0	4.0	3.7	4.0	3.7	4.0	3.7
All-Red Time (s)	2.0	2.0	2.0	2.0	2.0	2.0	2.0	2.0	2.0	2.0
Lost Time Adjust (s)	0.0	0.0	0.0	0.0	0.0	0.0	0.0	0.0	0.0	0.0
Total Lost Time (s)	5.7	6.0	5.7	6.0	6.0	5.7	6.0	5.7	6.0	5.7
Lead/Lag	Lead	Lag	Lead	Lag	Lag	Lead	Lag	Lead	Lag	Lead
Lead-Lag Optimize?	Yes	Yes	Yes	Yes	Yes	Yes	Yes	Yes	Yes	Yes
Recall Mode	None	None	None	None	None	None	C-Max	None	C-Max	None
Act Effct Green (s)	35.0	17.4	32.6	16.2	16.2	91.7	85.0	10.5	85.6	103.2
Actuated g/C Ratio	0.23	0.12	0.22	0.11	0.11	0.61	0.57	0.07	0.57	0.69
v/c Ratio	1.06	0.56	0.85	0.70	0.33	0.26	0.72	0.55	0.50	0.12
Control Delay	121.7	65.7	76.5	75.5	8.0	12.2	28.2	84.8	21.1	3.7
Queue Delay	0.0	0.0	0.0	0.0	0.0	0.0	0.0	0.0	0.0	0.0
Total Delay	121.7	65.7	76.5	75.5	8.0	12.2	28.2	84.8	21.1	3.7
LOS	F	E	E	E	A	B	C	F	C	A
Approach Delay		98.3		66.1			27.2		22.9	
Approach LOS		F		E			C		C	

Intersection Summary

Cycle Length: 150
 Actuated Cycle Length: 150
 Offset: 24 (16%), Referenced to phase 2:SBT and 6:NBTL, Start of Yellow
 Natural Cycle: 100
 Control Type: Actuated-Coordinated
 Maximum v/c Ratio: 1.06
 Intersection Signal Delay: 42.1
 Intersection Capacity Utilization 87.1%
 Analysis Period (min) 15
 Intersection LOS: D
 ICU Level of Service E

Splits and Phases: 104: Alton Road & Dade Boulevard

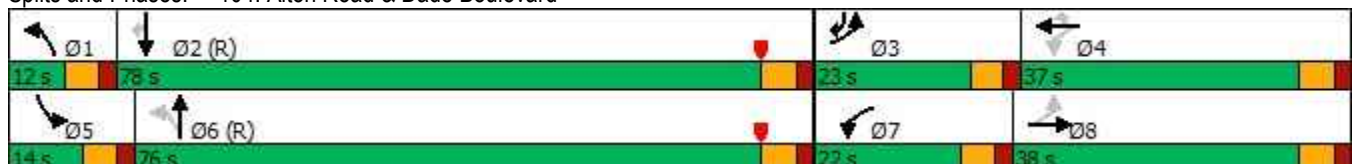

Queues

104: Alton Road & Dade Boulevard

09/18/2023



Lane Group	EBL	EBT	WBL	WBT	WBR	NBL	NBT	SBL	SBT	SBR
Lane Group Flow (vph)	281	202	234	238	80	85	1251	60	893	113
v/c Ratio	1.06	0.56	0.85	0.70	0.33	0.26	0.72	0.55	0.50	0.12
Control Delay	121.7	65.7	76.5	75.5	8.0	12.2	28.2	84.8	21.1	3.7
Queue Delay	0.0	0.0	0.0	0.0	0.0	0.0	0.0	0.0	0.0	0.0
Total Delay	121.7	65.7	76.5	75.5	8.0	12.2	28.2	84.8	21.1	3.7
Queue Length 50th (ft)	~269	95	200	120	0	28	467	58	265	13
Queue Length 95th (ft)	#363	136	#298	163	28	54	636	106	361	37
Internal Link Dist (ft)		316		456			473		500	
Turn Bay Length (ft)	220		185		60	350		185		70
Base Capacity (vph)	264	664	276	651	370	323	1735	115	1800	953
Starvation Cap Reductn	0	0	0	0	0	0	0	0	0	0
Spillback Cap Reductn	0	0	0	0	0	0	0	0	0	0
Storage Cap Reductn	0	0	0	0	0	0	0	0	0	0
Reduced v/c Ratio	1.06	0.30	0.85	0.37	0.22	0.26	0.72	0.52	0.50	0.12

Intersection Summary

~ Volume exceeds capacity, queue is theoretically infinite.

Queue shown is maximum after two cycles.

95th percentile volume exceeds capacity, queue may be longer.

Queue shown is maximum after two cycles.

HCM 6th Signalized Intersection Summary
104: Alton Road & Dade Boulevard

09/18/2023

Movement	EBL	EBT	EBR	WBL	WBT	WBR	NBL	NBT	NBR	SBL	SBT	SBR
Lane Configurations												
Traffic Volume (veh/h)	256	163	21	213	217	73	77	930	208	55	813	103
Future Volume (veh/h)	256	163	21	213	217	73	77	930	208	55	813	103
Initial Q (Qb), veh	0	0	0	0	0	0	0	0	0	0	0	0
Ped-Bike Adj(A_pbT)	0.99		1.00	0.98		1.00	1.00		0.98	1.00		0.98
Parking Bus, Adj	1.00	1.00	1.00	1.00	1.00	1.00	1.00	1.00	1.00	1.00	1.00	1.00
Work Zone On Approach		No			No			No			No	
Adj Sat Flow, veh/h/ln	1670	1670	1670	1670	1670	1670	1670	1670	1670	1670	1670	1670
Adj Flow Rate, veh/h	281	179	0	234	238	0	85	1022	229	60	893	113
Peak Hour Factor	0.91	0.91	0.91	0.91	0.91	0.91	0.91	0.91	0.91	0.91	0.91	0.91
Percent Heavy Veh, %	3	3	3	3	3	3	3	3	3	3	3	3
Cap, veh/h	296	447		315	426		298	1405	314	74	1773	935
Arrive On Green	0.12	0.14	0.00	0.11	0.13	0.00	0.04	0.55	0.55	0.05	0.56	0.56
Sat Flow, veh/h	1590	3256	0	1590	3173	1415	1590	2564	573	1590	3173	1381
Grp Volume(v), veh/h	281	179	0	234	238	0	85	631	620	60	893	113
Grp Sat Flow(s),veh/h/ln	1590	1586	0	1590	1586	1415	1590	1586	1550	1590	1586	1381
Q Serve(g_s), s	17.3	7.7	0.0	16.3	10.5	0.0	3.5	44.8	45.2	5.6	25.9	4.4
Cycle Q Clear(g_c), s	17.3	7.7	0.0	16.3	10.5	0.0	3.5	44.8	45.2	5.6	25.9	4.4
Prop In Lane	1.00		0.00	1.00		1.00	1.00		0.37	1.00		1.00
Lane Grp Cap(c), veh/h	296	447		315	426		298	869	850	74	1773	935
V/C Ratio(X)	0.95	0.40		0.74	0.56		0.29	0.73	0.73	0.81	0.50	0.12
Avail Cap(c_a), veh/h	296	677		315	656		308	869	850	88	1773	935
HCM Platoon Ratio	1.00	1.00	1.00	1.00	1.00	1.00	1.00	1.00	1.00	1.00	1.00	1.00
Upstream Filter(l)	1.00	1.00	0.00	1.00	1.00	0.00	1.00	1.00	1.00	1.00	1.00	1.00
Uniform Delay (d), s/veh	55.1	58.7	0.0	51.8	60.8	0.0	16.1	25.4	25.5	70.9	20.3	8.7
Incr Delay (d2), s/veh	38.3	0.4	0.0	8.1	0.9	0.0	0.2	5.3	5.5	31.4	1.0	0.3
Initial Q Delay(d3),s/veh	0.0	0.0	0.0	0.0	0.0	0.0	0.0	0.0	0.0	0.0	0.0	0.0
%ile BackOfQ(50%),veh/ln	6.4	3.1	0.0	2.0	4.3	0.0	1.3	18.0	17.8	2.9	9.9	1.4
Unsig. Movement Delay, s/veh												
LnGrp Delay(d),s/veh	93.4	59.1	0.0	60.0	61.6	0.0	16.3	30.7	31.0	102.3	21.4	8.9
LnGrp LOS	F	E		E	E		B	C	C	F	C	A
Approach Vol, veh/h		460			472			1336			1066	
Approach Delay, s/veh		80.0			60.8			29.9			24.6	
Approach LOS		F			E			C			C	
Timer - Assigned Phs	1	2	3	4	5	6	7	8				
Phs Duration (G+Y+Rc), s	11.1	89.8	23.0	26.1	12.7	88.2	22.0	27.1				
Change Period (Y+Rc), s	* 5.7	6.0	* 5.7	6.0	* 5.7	6.0	* 5.7	6.0				
Max Green Setting (Gmax), s	* 6.3	72.0	* 17	31.0	* 8.3	70.0	* 16	32.0				
Max Q Clear Time (g_c+I1), s	5.5	27.9	19.3	12.5	7.6	47.2	18.3	9.7				
Green Ext Time (p_c), s	0.0	2.7	0.0	1.1	0.0	3.3	0.0	0.9				

Intersection Summary

HCM 6th Ctrl Delay	39.5
HCM 6th LOS	D

Notes

* HCM 6th computational engine requires equal clearance times for the phases crossing the barrier.
Unsignalized Delay for [EBR, WBR] is excluded from calculations of the approach delay and intersection delay.

APPENDIX F

Maneuverability Analysis

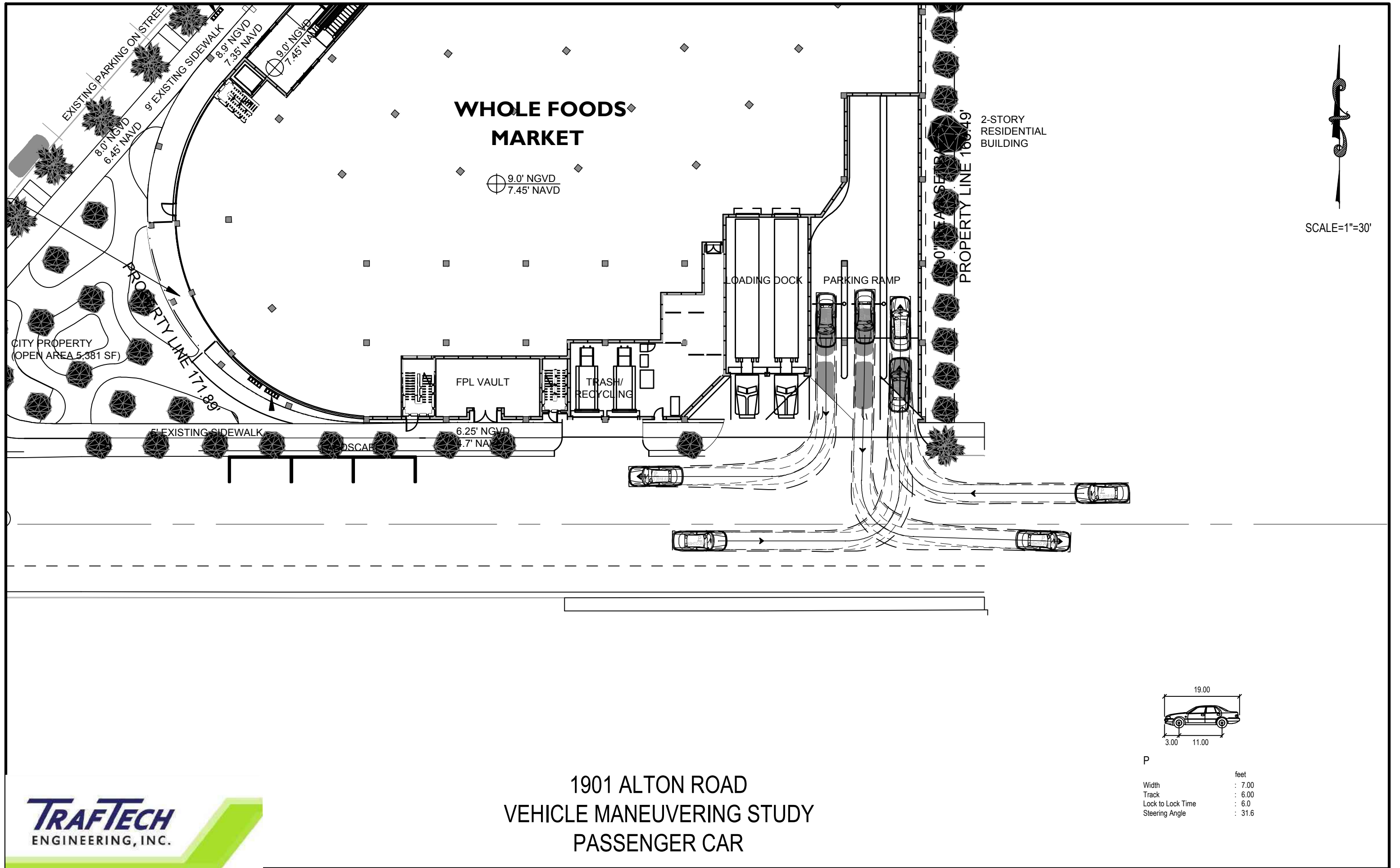

1901 ALTON ROAD
VEHICLE MANEUVERING STUDY
PASSENGER CAR

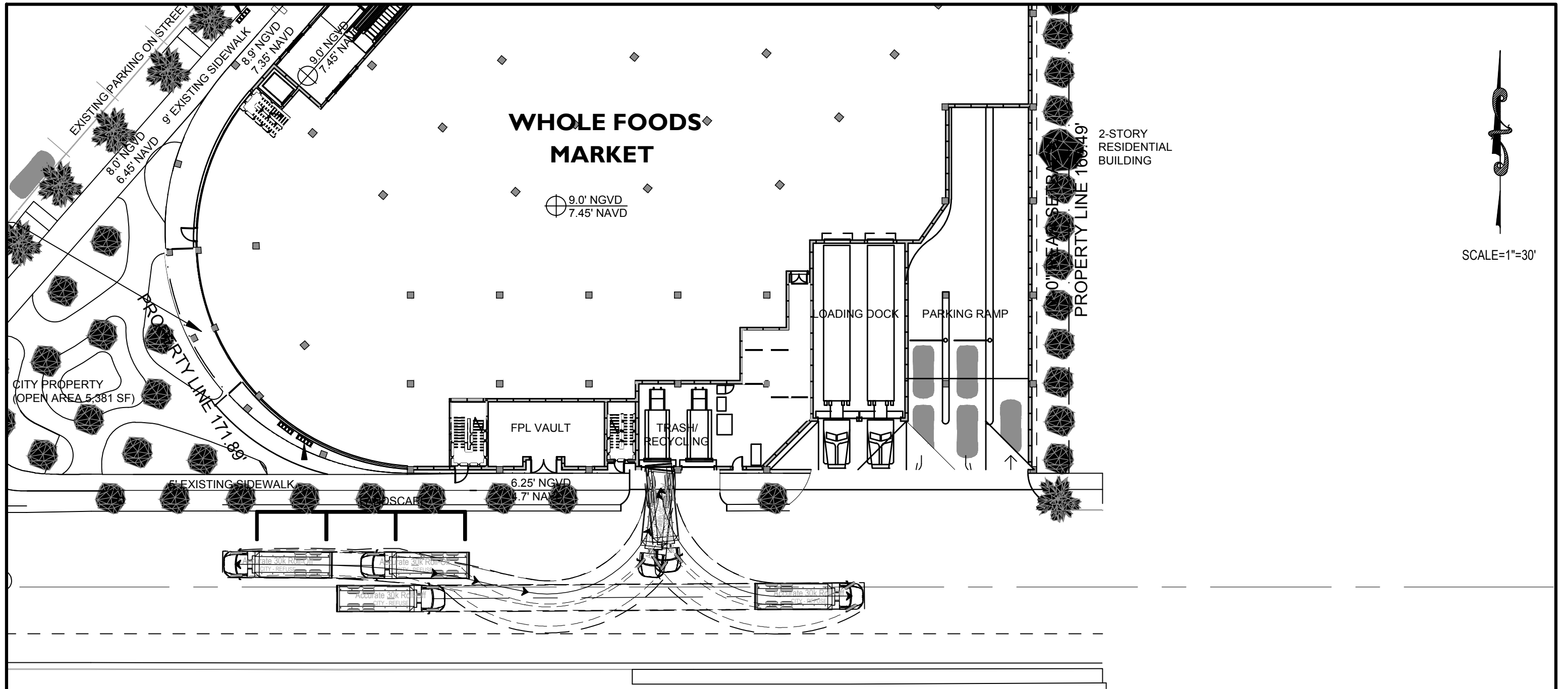

SCALE=1"=30'

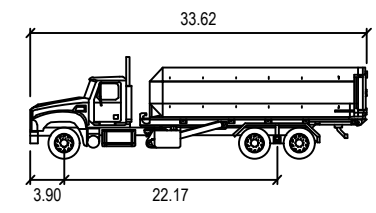

Accurate 30k Roll-Off

	feet
Width	: 8.17
Track	: 8.02
Lock to Lock Time	: 6.0
Steering Angle	: 32.7

1901 ALTON ROAD
VEHICLE MANEUVERING STUDY
GARBAGE TRUCK - BAY 1



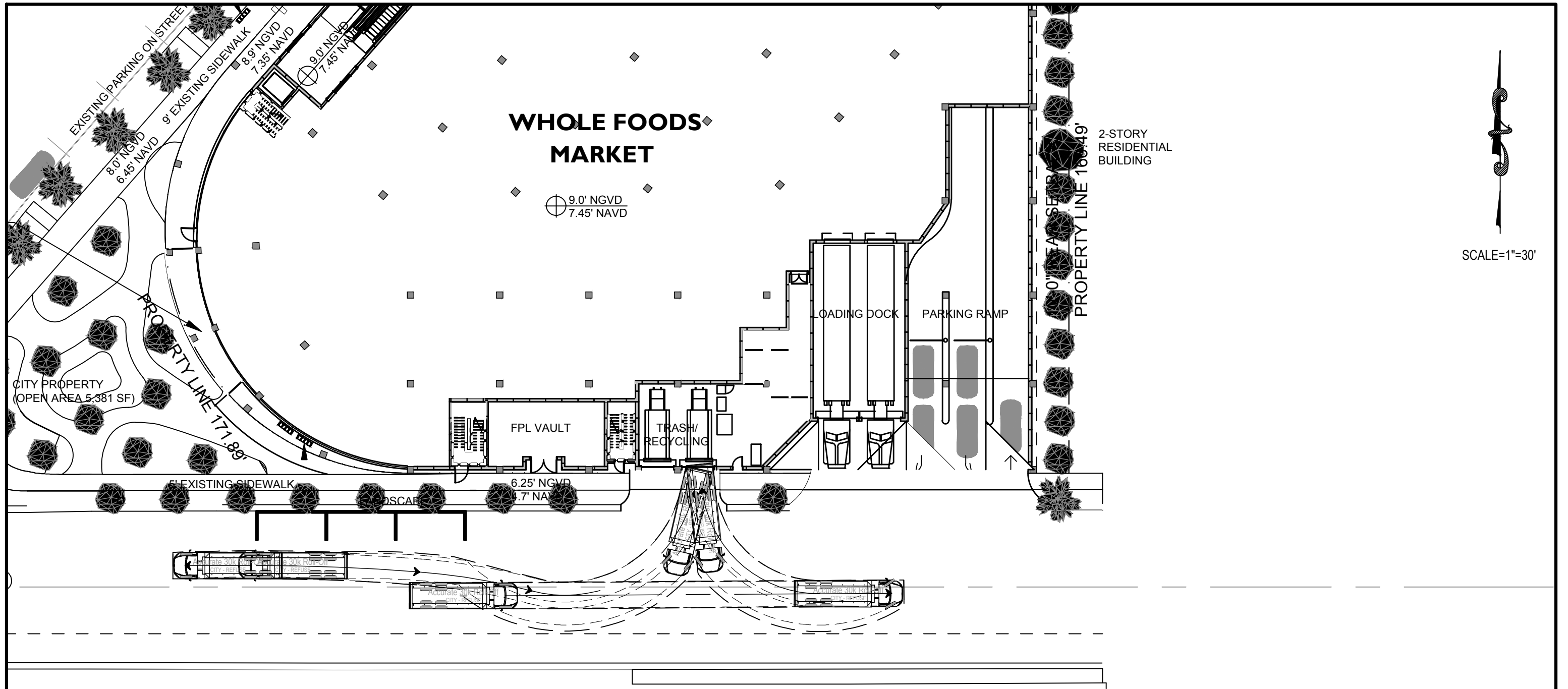

SCALE=1"=30'

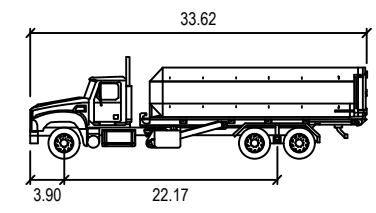

Accurate 30k Roll-Off

	feet
Width	: 8.17
Track	: 8.02
Lock to Lock Time	: 6.0
Steering Angle	: 32.7

1901 ALTON ROAD
VEHICLE MANEUVERING STUDY
GARBAGE TRUCK - BAY 2



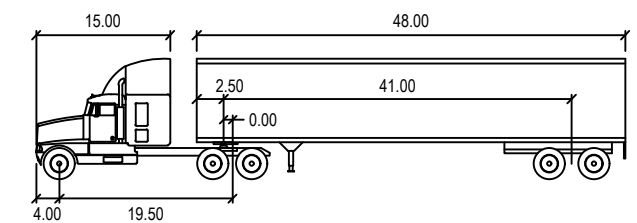
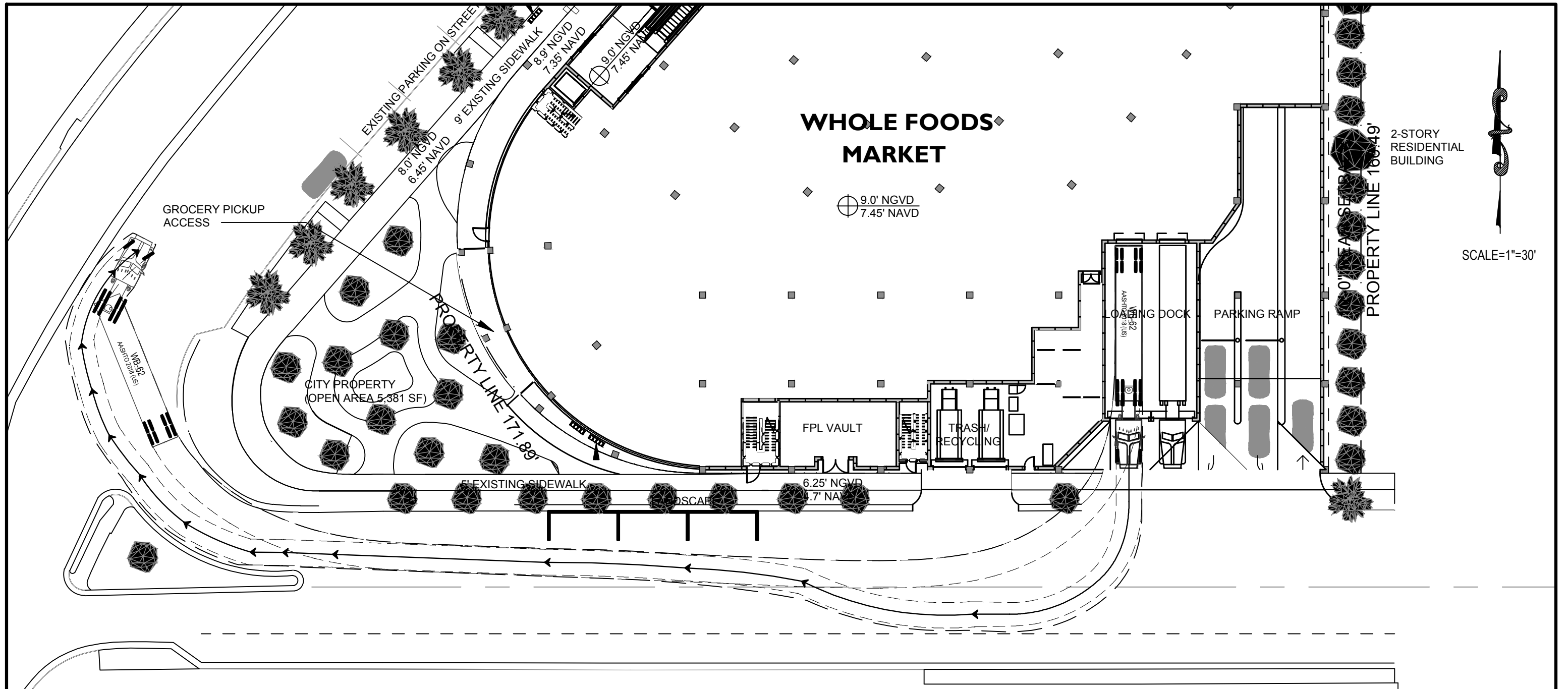

WB-62

	feet		
Tractor Width	: 4.00	Lock to Lock Time	: 6.0
Trailer Width	: 8.50	Steering Angle	: 28.4
Tractor Track	: 8.00	Articulating Angle	: 70.0
Trailer Track	: 8.50		

1901 ALTON ROAD
 VEHICLE MANEUVERING STUDY
 WB-62 TRUCK - BAY 1 - EGRESS



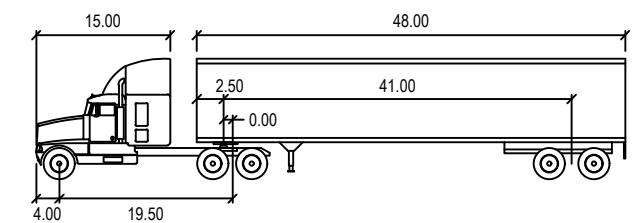
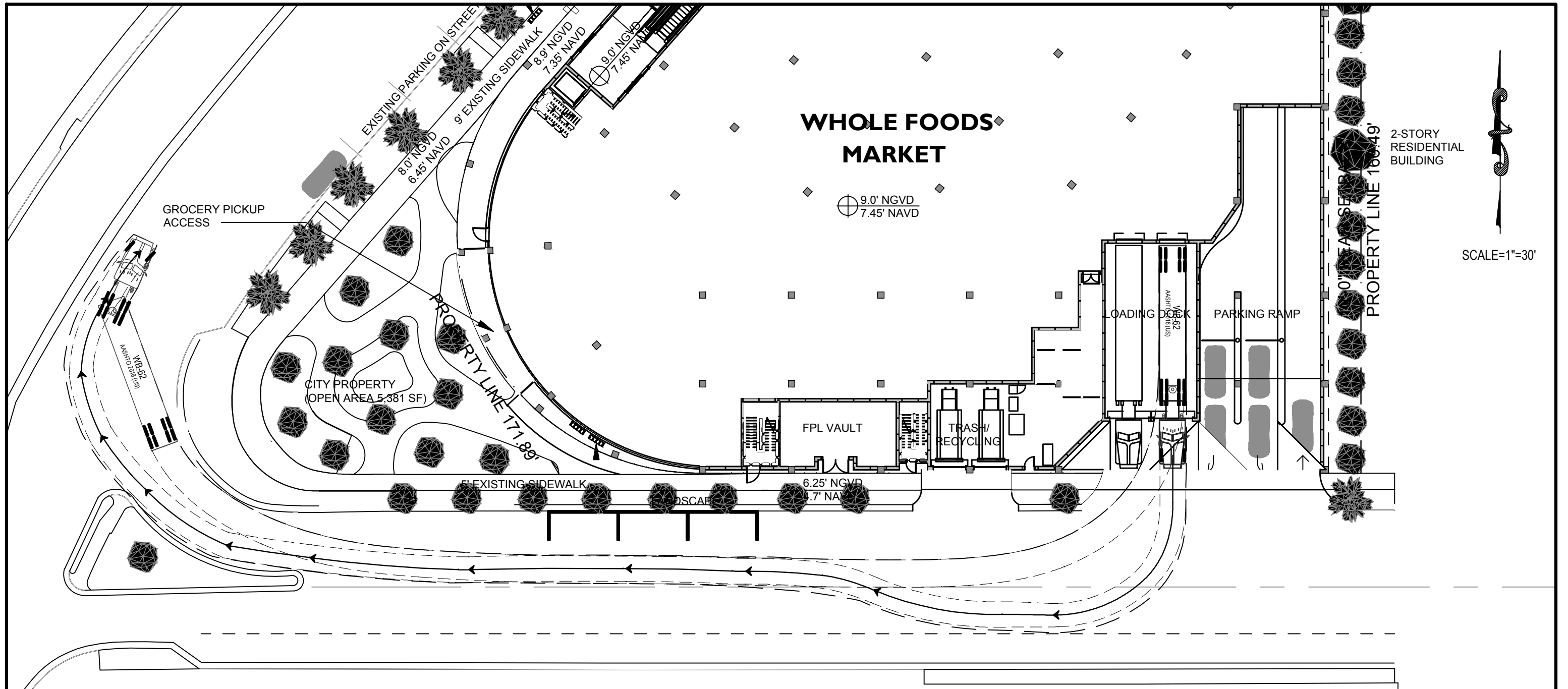

WB-62

feet	
Tractor Width	: 8.00
Trailer Width	: 8.50
Tractor Track	: 8.00
Trailer Track	: 8.50
Lock to Lock Time	: 6.0
Steering Angle	: 28.4
Articulating Angle	: 70.0

1901 ALTON ROAD
VEHICLE MANEUVERING STUDY
WB-62 TRUCK - BAY 1 - EGRESS



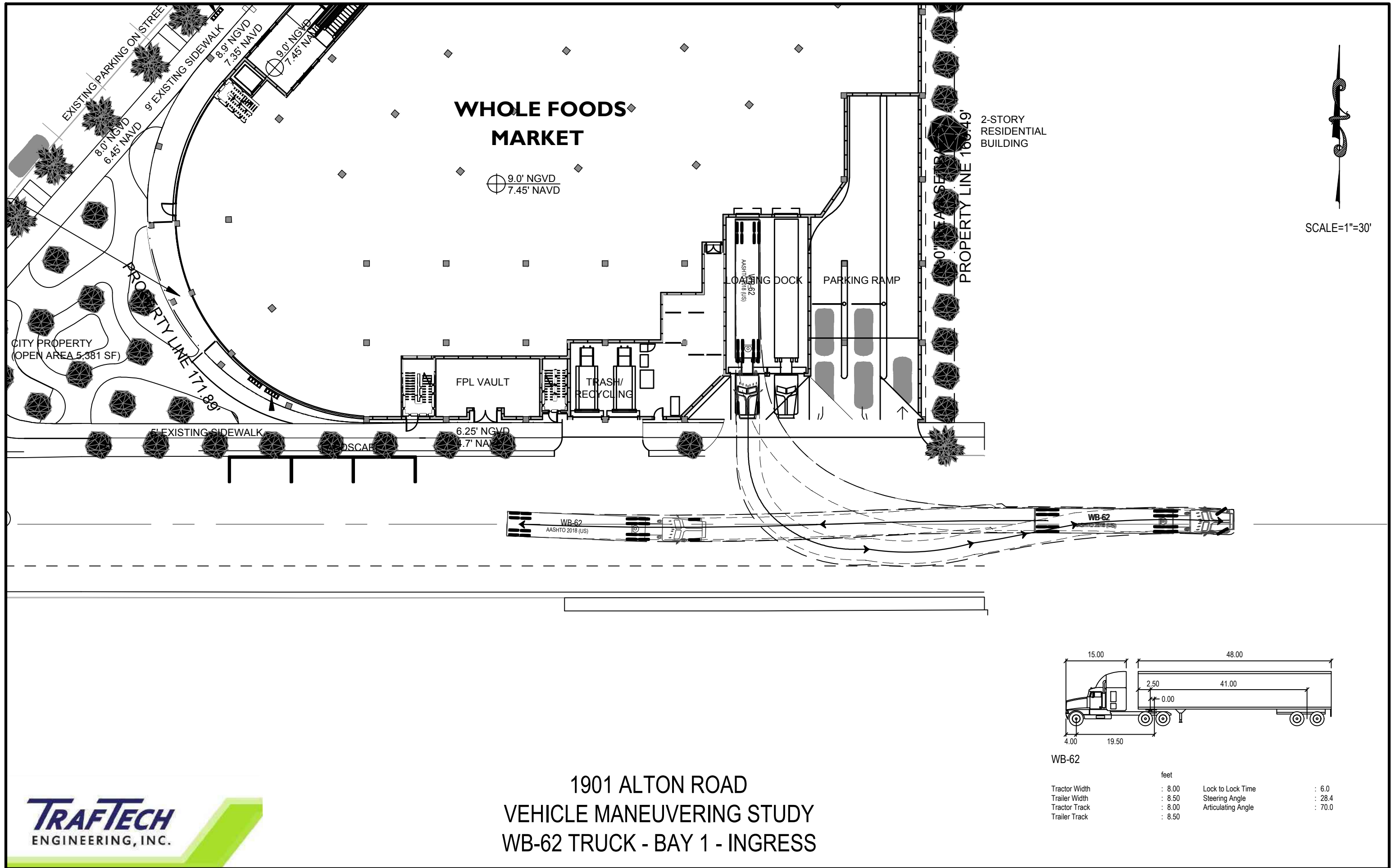

WHOLE FOODS MARKET

9.0' NGVD
7.45' NAVD

2-STORY RESIDENTIAL BUILDING

SCALE=1"=30'

CITY PROPERTY
(OPEN AREA 5,381 SF)

FPL VAULT

TRASH/
RECYCLING

LOADING DOCK

PARKING RAMP

WB-62
AASHTO 2018 (US)

WB-62
AASHTO 2018 (US)

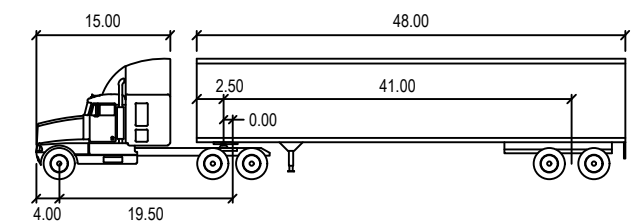

WB-62

	feet		
Tractor Width	: 8.00	Lock to Lock Time	: 6.0
Trailer Width	: 8.50	Steering Angle	: 28.4
Tractor Track	: 8.00	Articulating Angle	: 70.0
Trailer Track	: 8.50		



1901 ALTON ROAD
VEHICLE MANEUVERING STUDY
WB-62 TRUCK - BAY 1 - INGRESS

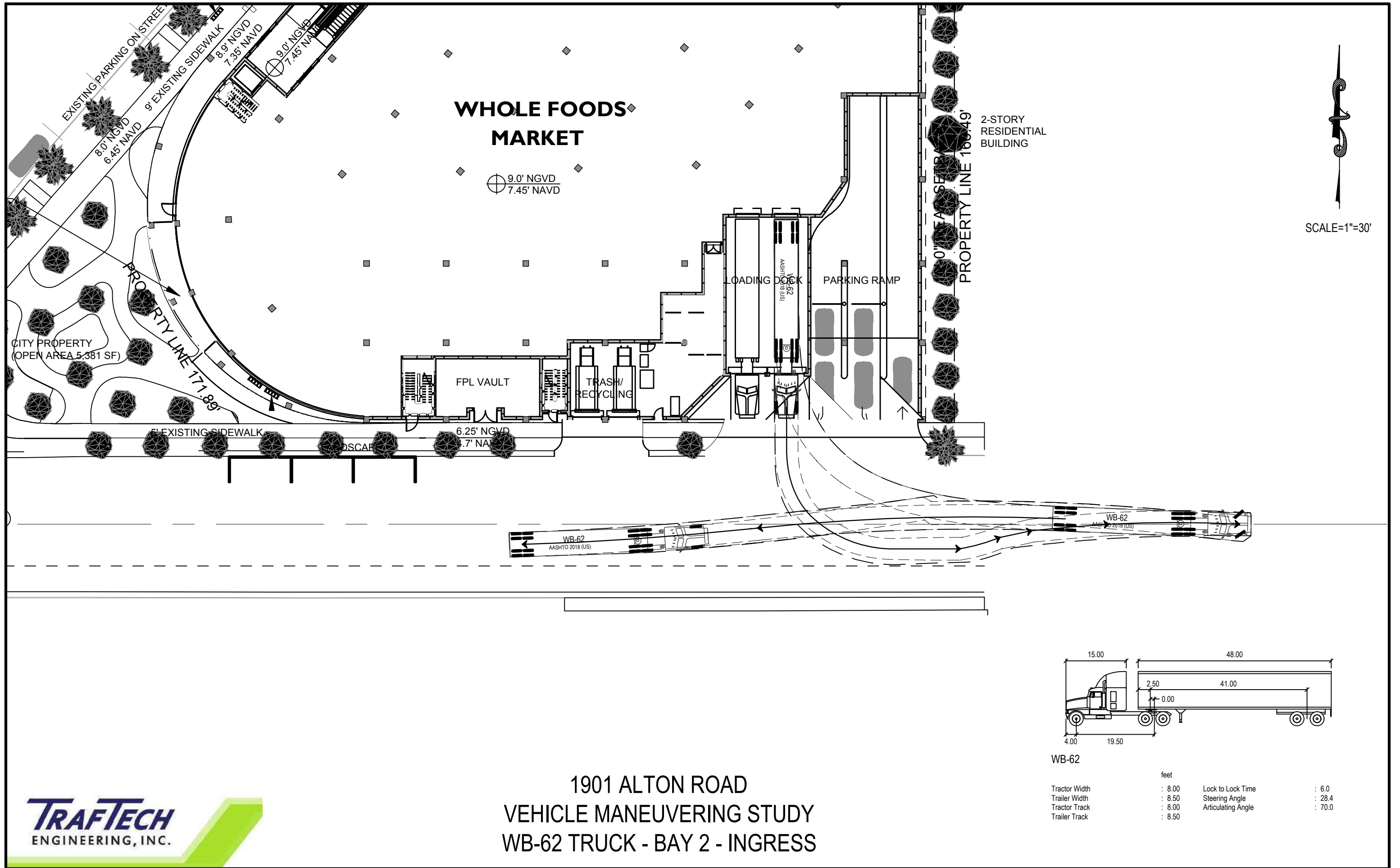

**WHOLE FOODS
MARKET**

9.0' NGVD
7.45' NAVD

2-STORY
RESIDENTIAL
BUILDING

SCALE=1"=30'

CITY PROPERTY
(OPEN AREA 5,381 SF)

FPL VAULT

TRASH/
RECYCLING

LOADING DOCK

PARKING RAMP

WB-62
AASHTO 2018 (US)

WB-62
AASHTO 2018 (US)

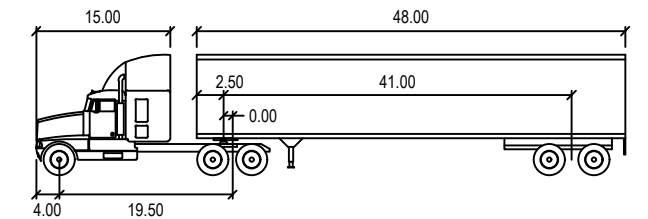

WB-62

		feet	
Tractor Width	: 8.00	Lock to Lock Time	: 6.0
Trailer Width	: 8.50	Steering Angle	: 28.4
Tractor Track	: 8.00	Articulating Angle	: 70.0
Trailer Track	: 8.50		

1901 ALTON ROAD
VEHICLE MANEUVERING STUDY
WB-62 TRUCK - BAY 2 - INGRESS



APPENDIX G

Response to Comments Letter

September 25, 2023

Mr. Otniel Rodriguez, E.I.
City of Miami Beach Transportation Department
1700 Convention Center Drive
Miami Beach, Florida 33139

**Re: 1901 Alton Road - Traffic Analysis Review Comments Dated
September 11, 2023**

Dear Otniel:

Traf Tech Engineering, Inc. has been retained by the Crecent Heights team to address the traffic-related comments prepared by Kimley Horn and Associates, Inc. The responses to the traffic-related comments are provided below:

1. Provide a formal response to comments document when preparing resubmittals.

***Response 1:** A response to Comments letter is included in the revised report. Please refer to Appendix G.*

2. Confirm the land use of the existing development. According to the Miami-Dade County Property Appraiser website, the existing development at 1901 Alton Road is a drive-through bank. However, according to the "Inventory" section of the traffic study, the existing land use is an 11,000 square-foot retail space.

***Response 2:** The existing land use was revised to Drive-in Bank and the square footage was revised to 6,654 square feet, per property appraiser report.*

3. The proposed square footage for both the supermarket and the drive-in bank varies from the approved methodology. Provide the final proposed square footages of the Supermarket and Bank in the traffic study and as part of the response to this comment.

***Response 3:** Square footages of both land uses were revised, based on the latest site plan.*

4. The approved methodology and traffic study should have consistent land uses and similar square feet and/or units. Please revise the documentation to be consistent and update trip generation accordingly.

***Response 4:** Trip generation calculations were revised accordingly. Since the traffic methodology, the square feet of the land uses changed. The latest changes are reflected in the updated traffic study.*

5. Provide a zoning data sheet detailing the scale and required/provided parking of all proposed land uses.

***Response 5:** A table summarizing the information requested was included in the revised report under the parking section.*

6. Confirm the date of traffic data collection. According to the "Traffic Counts" section of the traffic study, traffic data was collected on December 1, 2022. However, according to Appendix B, traffic data was collected on August 9, 2023.

***Response 6:** The date of the counts was revised to August 9, 2023.*

7. The 2045 Miami-Dade Cardinal Trip Distribution for the WNW direction in TAZ 634 should be 13.6 percent (13.6%). As other changes will most likely made throughout the traffic study, please update cardinal trip distribution calculations accordingly, if needed.

***Response 7:** The incorrect percentage was revised and all calculations were revised accordingly.*

8. Clarify how the growth rate of 2.3 percent (2.3%) was selected as the study area growth rate as the growth rate with the highest R-squared value is the decaying exponential 10-year.

***Response 8:** The growth rate was revised accordingly.*

9. Identify the number of required parking spaces in the "Parking" section of the traffic study.

Response 9: Table 4 summarizes the number of required parking spaces.

10. The site plan contains grocery pick-up spaces where currently on-street parking is provided. Clarify the intended operation and confirm that sufficient stacking is provided. Note that coordination with the Parking Department will be needed for the elimination of the on-street parking spaces.

Response 10: The intent of these parking spaces is for grocery pick-up service. These parking stalls will have similar dimensions as a regular on-street parking space. Prior to providing any grocery pick-up signs, coordination with the City's Parking Department will be held to ensure the city approves the use of these parking spaces for grocery pick-up service.

11. Consistent with the methodology comments provided, include a maneuverability analysis section in the report and provide maneuverability exhibits for passenger vehicles within the parking garage and loading areas as an appendix within the study.

Response 11: The section was added to the revised report and exhibits are included in Appendix H.

12. The proposed driveway appears to accommodate parking revenue equipment. Confirm if an entry gate will be provided. If so, provide an entry gate queuing analysis.

Response 12: Entry gates are not proposed for this project.

13. The curb and gutter at the project driveway appear to block the entry lane and the loading area. Please clarify.

Response 13: The entry/exit lanes of the driveway and the loading dock access will not have curb and gutter. The site plan was revised to eliminate the curb and gutter in front of the entry lane and loading area.

14. Include Project Driveway intersection in Figure 6.

Response 14: The project driveway was included in Figure 6.

15. Provide volume development worksheets for the project driveway as well.

Response 15: Volume Development Sheets for the project driveway were included in Appendix D.

16. Please review the Synchro comments below and update models accordingly:

- a. Dade Boulevard and Michigan Avenue
 - i. The westbound approach should be modeled as two (2) through lanes and one (1) right-turn lane.
 - ii. The southeastbound approach should be modeled as two (2) left-turn lanes and one (1) right-turn lane.
 - iii. Signal operates as coordinated.
- b. Dade Boulevard and Alton Road
 - i. the southbound left-turn lane should be modeled with storage length.
 - ii. A.M. and P.M. peak hour cycle lengths should be 150s, round yellow time when calculating max splits.
 - iii. Phases 7 and 8 have incorrect max splits.
 - iv. Please explain why the detector phases for north and south approaches have been overridden.
- c. Alton Road and 20th Street
 - i. A.M. and P.M. peak hour cycle lengths should be 150s, round yellow time when calculating max splits.
 - ii. Phase 4 minimum gap is incorrect.
Please explain why the detector phases for southwest and northeast approaches have been overridden.
- d. Alton Road and Michigan Avenue
 - i. SOP is not included in the appendices.
 - ii. Please explain why the detector phases for southwest and northeast approaches have been overridden.

Response 16: Synchro files were updated to address all comments and the SOP for the intersection of Alton Road and Michigan Avenue was included in the Appendix.

17. The eastbound approach at the intersection of Alton Road and Dade Boulevard worsens to LOS F/131.0 under future conditions during the AM peak hour. Provide mitigation.

Response 17: Minor signal optimization is proposed to mitigate additional delays.

18. The southwestbound left-turn movement is expected to exceed provided storage under future conditions. Provide mitigation.

Response 18: The movement is expected to exceed the provided storage under background condition scenario without the project traffic in place. The impact of the project trips on this queue is 17 ft or less than one vehicle. Therefore, mitigation is not provided.

19. Provide the width of sidewalks in the multimodal evaluation section.

Response 19: The width was added to the section. The width of the sidewalk along Alton Road is nine (9) feet and along 19th Street it is five (5) feet.

20. Provide Transportation Demand Management strategies to reduce single-occupant vehicular traffic and encourage patrons and employees to walk, bike, use public transportation, and carpool/vanpool. Below is a list of strategies that should be considered for implementation by the project:

- a. Creation of an Employee Transportation Coordinator position to run the transportation demand management (TDM) programs.
- b. Provide secure bicycle parking (bicycle racks and/lockers). If so, how many and will they be short-term and/or long-term?
- c. Provide transit information within the site including route schedules and maps.
- d. Carpool incentive program for employees.
- e. Improved, enhanced (wide) sidewalks around the site.
- f. Subsidized transit passes for employees.
- g. Providing a Citibike station or bike sharing/rentals.
- h. Car/vanpooling designated parking spaces.

i. Lockers for bicyclists to store a change of clothes will be provided on-site.

j. Shower facility, bicyclist can use will be provided on-site

Response 20: *A transportation Demand Management section was added to the report to address this comment.*

Please call me if you have any questions.

Sincerely,

TRAF TECH ENGINEERING, INC.

Joaquin E. Vargas, P.E.
Senior Transportation Engineer

October 9, 2023

Mr. Otniel Rodriguez, E.I.
City of Miami Beach Transportation Department
1700 Convention Center Drive
Miami Beach, Florida 33139

**Re: 1901 Alton Road - Traffic Analysis Review Comments Dated
September 11, 2023**

Dear Otniel:

Traf Tech Engineering, Inc. has been retained by the Crecent Heights team to address the traffic-related comments prepared by Kimley Horn and Associates, Inc. The responses to the traffic-related comments are provided below:

1. Provide a formal response to comments document when preparing resubmittals.

***Response 1:** A response to Comments letter is included in the revised report. Please refer to Appendix G.*

2. Confirm the land use of the existing development. According to the Miami-Dade County Property Appraiser website, the existing development at 1901 Alton Road is a drive-through bank. However, according to the "Inventory" section of the traffic study, the existing land use is an 11,000 square-foot retail space.

***Response 2:** The existing land use was revised to Drive-in Bank and the square footage was revised to 6,654 square feet, per property appraiser report.*

3. The proposed square footage for both the supermarket and the drive-in bank varies from the approved methodology. Provide the final proposed square footages of the Supermarket and Bank in the traffic study and as part of the response to this comment.

***Response 3:** Square footages of both land uses were revised, based on the latest site plan.*

4. The approved methodology and traffic study should have consistent land uses and similar square feet and/or units. Please revise the documentation to be consistent and update trip generation accordingly.

***Response 4:** Trip generation calculations were revised accordingly. Since the traffic methodology, the square feet of the land uses changed. The latest changes are reflected in the updated traffic study.*

10/3/2023 Follow-up Comment: Comment partially addressed. On Page 8 of the Traffic Study (Trip Generation), please correct the discrepancy between the proposed LUC's in the Trip Generation Table description and those shown in the table.

Response 10/9/2023: The discrepancy has been corrected.

5. Provide a zoning data sheet detailing the scale and required/provided parking of all proposed land uses.

***Response 5:** A table summarizing the information requested was included in the revised report under the parking section.*

6. Confirm the date of traffic data collection. According to the "Traffic Counts" section of the traffic study, traffic data was collected on December 1, 2022. However, according to Appendix B, traffic data was collected on August 9, 2023.

***Response 6:** The date of the counts was revised to August 9, 2023.*

7. The 2045 Miami-Dade Cardinal Trip Distribution for the WNW direction in TAZ 634 should be 13.6 percent (13.6%). As other changes will most likely made throughout the traffic study, please update cardinal trip distribution calculations accordingly, if needed.

***Response 7:** The incorrect percentage was revised and all calculations were revised accordingly.*

8. Clarify how the growth rate of 2.3 percent (2.3%) was selected as the study area growth rate as the growth rate with the highest R-squared value is the decaying exponential 10-year.

Response 8: The growth rate was revised accordingly.

10/3/2023 Follow-up Comment: Comment partially addressed. Appendix D indicates the 10-year decaying exponential growth rate of 2.9 percent (2.9%) was applied to the existing conditions volumes. However, please revise the "Future Conditions Traffic Volumes" section to state a 2.9 percent (2.9%) growth rate was used rather than a 2.3 percent (2.3%) growth rate. Note the results of the analysis are not expected to change based on the above changes.

Response 10/9/2023: The "Future Conditions Traffic Volumes" section was revised to indicate 2.9%.

9. Identify the number of required parking spaces in the "Parking" section of the traffic study.

Response 9: Table 4 summarizes the number of required parking spaces.

10. The site plan contains grocery pick-up spaces where currently on-street parking is provided. Clarify the intended operation and confirm that sufficient stacking is provided. Note that coordination with the Parking Department will be needed for the elimination of the on-street parking spaces.

Response 10: The intent of these parking spaces is for grocery pick-up service. These parking stalls will have similar dimensions as a regular on-street parking space. Prior to providing any grocery pick-up signs, coordination with the City's Parking Department will be held to ensure the city approves the use of these parking spaces for grocery pick-up service.

10/3/2023 Follow-up Comment: Comment partially addressed. Please reach out to the Parking Department to discuss the use of these on-street parking spaces for curbside pickup. This must first be confirmed or denied by the Parking Department before we can approve the Traffic Study, as it impacts maneuverability, queuing, and available parking spaces for the project.

Response 10/9/2023: The grocery pick-up parking spaces have been removed from the site plan (please refer to updated site plan contained in Appendix A).

11. Consistent with the methodology comments provided, include a maneuverability analysis section in the report and provide maneuverability exhibits for passenger vehicles within the parking garage and loading areas as an appendix within the study.

Response 11: *The section was added to the revised report and exhibits are included in Appendix H.*

10/3/2023 Follow-up Comment: Comment partially addressed. Revise the "Maneuverability Analysis" section to identify all vehicles utilized in the maneuverability analysis. Additionally, in Appendix F, include the maneuverability analysis of the passenger vehicle driveway maneuvers.

Furthermore, note that loading vehicles reversing off of/onto public right-of-way, loading vehicles conflicting with oncoming traffic, and on-street loading operations require coordination with the City of Miami Beach. Note that all back-in maneuvers from public right-of-way require a dockmaster.

Response 10/9/2023: The updated AutoTURN analysis is provided in Appendix F. If desired by the City of Miami Beach, a dockmaster can be provided at the loading docks during deliveries.

12. The proposed driveway appears to accommodate parking revenue equipment. Confirm if an entry gate will be provided. If so, provide an entry gate queuing analysis.

Response 12: *Entry gates are not proposed for this project.*

10/3/2023 Follow-up Comment: The below screenshot appears to show exit gates in the marked area. Please clarify.

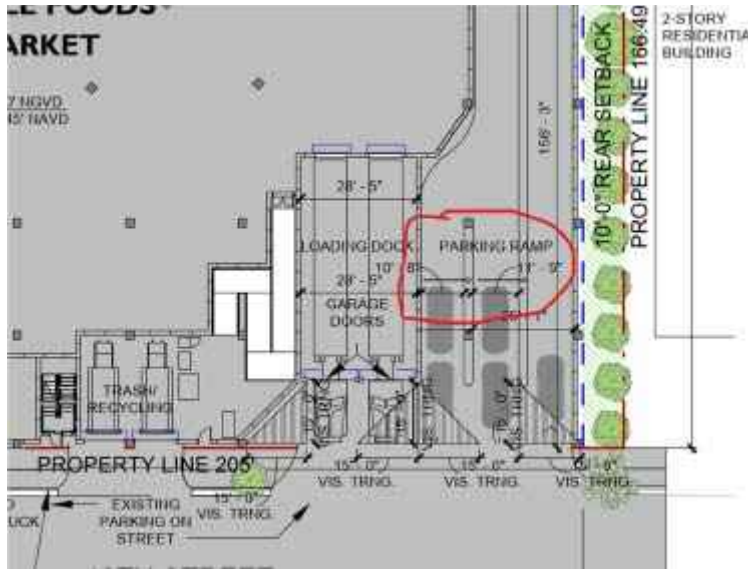

Response 10/9/2023: The gates are for exiting lanes only and therefore, will not affect inbound vehicles.

13. The curb and gutter at the project driveway appear to block the entry lane and the loading area. Please clarify.

Response 13: The entry/exit lanes of the driveway and the loading dock access will not have curb and gutter. The site plan was revised to eliminate the curb and gutter in front of the entry lane and loading area.

14. Include Project Driveway intersection in Figure 6.

Response 14: The project driveway was included in Figure 6.

15. Provide volume development worksheets for the project driveway as well.

Response 15: Volume Development Sheets for the project driveway were included in Appendix D.

10/3/2023 Follow-up Comment: Comment partially addressed. Revise the title of the project driveway intersection volume development sheet. Giving it the same title as another study intersection's volume development sheet is confusing.

Response 10/9/2023: The project driveway title has been revised.

16. Please review the Synchro comments below and update models accordingly:

- a. Dade Boulevard and Michigan Avenue
 - i. The westbound approach should be modeled as two (2) through lanes and one (1) right-turn lane.
 - ii. The southeastbound approach should be modeled as two (2) left-turn lanes and one (1) right-turn lane.
 - iii. Signal operates as coordinated.
- b. Dade Boulevard and Alton Road
 - i. the southbound left-turn lane should be modeled with storage length.
 - ii. A.M. and P.M. peak hour cycle lengths should be 150s, round yellow time when calculating max splits.
 - iii. Phases 7 and 8 have incorrect max splits.
 - iv. Please explain why the detector phases for north and south approaches have been overridden.
- c. Alton Road and 20th Street
 - i. A.M. and P.M. peak hour cycle lengths should be 150s, round yellow time when calculating max splits.
 - ii. Phase 4 minimum gap is incorrect.
Please explain why the detector phases for southwest and northeast approaches have been overridden.
- d. Alton Road and Michigan Avenue
 - i. SOP is not included in the appendices.
 - ii. Please explain why the detector phases for southwest and northeast approaches have been overridden.

Response 16: *Synchro files were updated to address all comments and the SOP for the intersection of Alton Road and Michigan Avenue was included in the Appendix.*

17. The eastbound approach at the intersection of Alton Road and Dade Boulevard worsens to LOS F/131.0 under future conditions during the AM peak hour. Provide mitigation.

Response 17: *Minor signal optimization is proposed to mitigate additional delays.*

18. The southwestbound left-turn movement is expected to exceed provided storage under future conditions. Provide mitigation.

Response 18: The movement is expected to exceed the provided storage under background condition scenario without the project traffic in place. The impact of the project trips on this queue is 17 ft or less than one vehicle. Therefore, mitigation is not provided.

19. Provide the width of sidewalks in the multimodal evaluation section.

Response 19: The width was added to the section. The width of the sidewalk along Alton Road is nine (9) feet and along 19th Street it is five (5) feet.

10/3/2023 Follow-up Comment: Comment partially addressed. As other sections of the report will be updated, please include the above information in the "Pedestrian Access" section of the report in the "Multimodal Evaluation" section.

Response 10/9/2023: The sidewalk widths for both Alton Road and 19th Street have been added to the "Pedestrian Access" section of the report in the "Multimodal Evaluation" section.

20. Provide Transportation Demand Management strategies to reduce single-occupant vehicular traffic and encourage patrons and employees to walk, bike, use public transportation, and carpool/vanpool. Below is a list of strategies that should be considered for implementation by the project:

- a. Creation of an Employee Transportation Coordinator position to run the transportation demand management (TDM) programs.
- b. Provide secure bicycle parking (bicycle racks and/lockers). If so, how many and will they be short-term and/or long-term?
- c. Provide transit information within the site including route schedules and maps.
- d. Carpool incentive program for employees.
- e. Improved, enhanced (wide) sidewalks around the site.
- f. Subsidized transit passes for employees.
- g. Providing a Citibike station or bike sharing/rentals.

- h. Car/vanpooling designated parking spaces.
- i. Lockers for bicyclists to store a change of clothes will be provided on-site.
- j. Shower facility, bicyclist can use will be provided on-site

Response 20: A transportation Demand Management section was added to the report to address this comment.

21. 10/3/2023 Follow-up: The Methodology must be in accordance with the Traffic Study. Please submit a Revised Methodology with your next response to comments with the aforementioned new square footages updated in order for both documents to be consistent.

Response 10/9/2023: The updated traffic methodology is consistent with the latest square footages and is included in the October 9, 2023 traffic study.

22. 10/3/2023 Follow-up: Please clarify how the site plan will be changing as the result of the square footage changes.

Response 10/9/2023: The final updated site plan is contained in Appendix A. No changes were incorporated other than minor adjustments in square footages.

23. 10/3/2023 Follow-up: Please ensure the Trip Generation Table, the Parking Summary, and the Conclusion in the Traffic Study are consistent with the newly proposed square footages.

Response 10/9/2023: The trip generation, parking and site plan are consistent in square footages.

Please call me if you have any questions.

Sincerely,

TRAF TECH ENGINEERING, INC.

Joaquin E. Vargas, P.E.
Senior Transportation Engineer

December 1, 2023

Mr. Otniel Rodriguez, E.I.
City of Miami Beach Transportation Department
1700 Convention Center Drive
Miami Beach, Florida 33139

Re: 1901 Alton Road - Traffic Analysis Review Comments Dated October 16, 2023

Dear Otniel:

Traf Tech Engineering, Inc. has been retained by the Crecent Heights team to address the traffic-related comments prepared by Kimley Horn and Associates, Inc. The comments and responses to the pending traffic-related comments are provided below:

10. The site plan contains grocery pick-up spaces where currently on-street parking is provided. Clarify the intended operation and confirm that sufficient stacking is provided. Note that coordination with the Parking Department will be needed for the elimination of the on-street parking spaces.

Response: The intent of these parking spaces is for grocery pick-up service. These parking stalls will have similar dimensions as a regular on-street parking space. Prior to providing any grocery pick-up signs, coordination with the City's Parking Department will be held to ensure the city approves the use of these parking spaces for grocery pick-up service.

10/03/2023 Follow-up: Comment partially addressed. Please reach out to the Parking Department to discuss the use of these on-street parking spaces for curbside pickup. This must first be confirmed or denied by the Parking Department before we can approve the Traffic Study, as it impacts maneuverability, queuing, and available parking spaces for the project.

10/09/2023 Response: The grocery pick-up parking spaces have been removed from the site plan (please refer to updated site plan contained in Appendix A).

10/16/2023 Follow-up: According to the site plan provided in Appendix A, the “loading zone to accommodate truck movements” may conflict with existing on-street parking spaces on the north side of 19th Street. Please add a section to the traffic study discussing the project impacts to existing on-street parking spaces. Note that coordination with the Parking Department will be needed for the elimination of on-street parking spaces and creation of a Loading Zone.

Response 10: The AutoTURN analyses for the large trucks have been revised (refer to Appendix F). As shown in the revised AutoTURN analyses, the large trucks do not impact the on-street parking spaces located on the south side of 19th Street. Hence, coordination with the City of Miami Beach Parking Department is not necessary.

11. Consistent with the methodology comments provided, include a maneuverability analysis section in the report and provide maneuverability exhibits for passenger vehicles within the parking garage and loading areas as an appendix within the study.

Response: The section was added to the revised report and exhibits are included in Appendix H.

10/03/2023 Follow-up: Comment partially addressed. Revise the “Maneuverability Analysis” section to identify all vehicles utilized in the maneuverability analysis. Additionally, in Appendix F, include the maneuverability analysis of the passenger vehicle driveway maneuvers.

Furthermore, note that loading vehicles reversing off of/onto public right-of-way, loading vehicles conflicting with oncoming traffic, and on-street loading operations require coordination with the City of Miami Beach. Note that all back-in maneuvers from public right-of-way require a dockmaster.

10/09/2023 Response: The updated AutoTURN analysis is provided in Appendix F. If desired by the City of Miami Beach, a dockmaster can be provided at the loading docks during deliveries.

10/16/2023 Follow-up: Comment partially addressed. Revise the “Maneuverability Analysis” section to identify loading vehicles

utilized in the maneuverability analysis as well. Additionally, in Appendix F, please address the following items:

- Include the maneuverability analysis of the passenger vehicle driveway maneuvers as they have not been included in the updated traffic study.
- Include on-street parking spaces on the south side of 19th Street in all maneuverability exhibits to confirm loading maneuvers do not conflict with these spaces.
- Include the centerline of 19th Street on all maneuverability exhibits to confirm maneuvers would not conflict with oncoming traffic.
- Revise loading maneuvers in top-left and bottom-left maneuverability exhibits. Note that the truck is shown blocking a travel lane and a crosswalk for dumpster loading and unloading. These maneuvers need to be contained on-site not blocking travel lanes.

As mentioned previously, a dockmaster will be required. Please revise the "Maneuverability Analysis" section to state that a dockmaster will be provided by the project.

Response 11: The maneuverability analyses have been updated and the text indicates a dockmaster will be provided for loading/unloading operations. The roadway's center line, and on-street parking spaces on the south side are depicted in the AutoTURN analyses. The garbage pickup has been updated with the appropriate truck. These trucks will be required to block the eastbound and westbound lanes of 19th Street for a short period of time. A dockmaster is recommended for the garbage pickup operation. P-class vehicle's AutoTURN were also evaluated.

12. The proposed driveway appears to accommodate parking revenue equipment. Confirm if an entry gate will be provided. If so, provide an entry gate queuing analysis.

Response 12: Entry gates are not proposed for this project.

10/3/2023 Follow-up Comment: The below screenshot appears to show exit gates in the marked area. Please clarify.

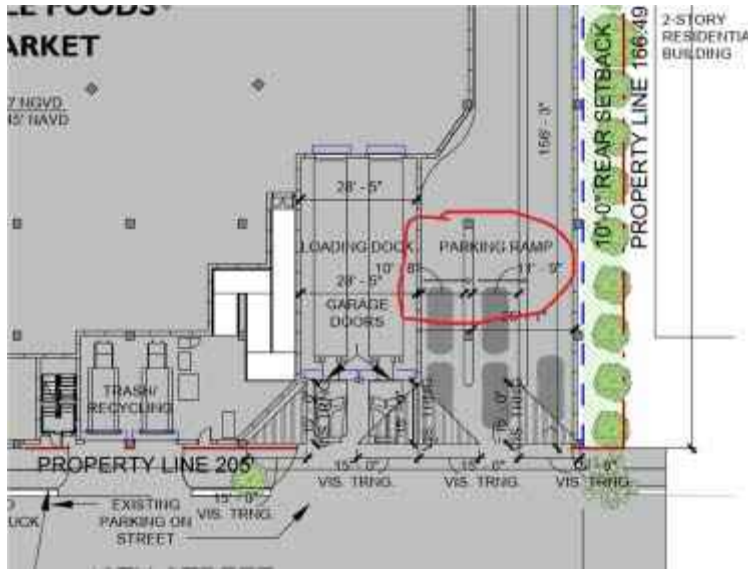

Response 10/9/2023: The gates are for exiting lanes only and therefore, will not affect inbound vehicles.

10/16/2023 Follow-up: Confirm entry gate operations. Typically, an entry gate is provided if exit gates are also provided.

***Response 12:** As depicted in the latest site plan, only exit gates are provided (no entry gates). The exit gates will open automatically as exit vehicles approach the gates. The exit gates are intended to discourage inbound vehicles from entering the parking garage via an exit lane.*

Please call me if you have any questions.

Sincerely,

TRAFTECH ENGINEERING, INC.

Joaquin E. Vargas, P.E.
Senior Transportation Engineer

APPENDIX H

Approved Traffic Methodology

PROPOSED TRAFFIC METHODOLOGY

- The trip generation analysis will be based upon the Institute of Transportation Engineers (ITE) *Trip Generation Manual (11th Edition)*. Table 1 documents the trip generation associated with the proposed supermarket/bank development.
- The trip distribution and assignment of project traffic will be based upon the applicable TAZ data contained within the Long-Range Transportation Plan (LRTP) published by the Miami-Dade MPO. The distribution will be interpolated between the 2015 and 2045 model years for the appropriate buildout year (tentatively estimated to be 2025).
- The subject traffic study will evaluate the following intersections during the typical AM and PM peak periods:
 - Dade Boulevard and Alton Road (signalized)
 - Alton Road and 19th Street (stop control)
 - Alton Road and 20th Street (signalized)
 - Alton Road and Michigan Avenue (signalized)
 - Michigan Avenue and Dade Boulevard (signalized)
- Traffic counts will be adjusted to reflect average peak season conditions based upon the most recent available FDOT adjustment factors.
- No adjustment to account for Covid will be applied (it is believed that traffic conditions are similar to pre-covid conditions).
- A growth factor will be applied to the traffic counts to reflect future traffic conditions at project build-out. The growth factor will be based upon historical traffic data available for the area near the project site.
- Traffic associated with the committed developments will be provided by the City of Miami Beach. The 1920 Alton project will be included as committed development.
- Existing traffic signal timing data for the study intersections will be obtained from Miami-Dade County DTPW and will be included in the Appendix of the traffic study.

- Traffic analysis will be prepared for each of the study intersections and project driveways for the following scenarios:
 - Existing (2023) traffic conditions
 - Background traffic conditions for buildout year (2026)
 - Future conditions with growth rate, committed development and project traffic for the buildout year (2026)
- The level of service and delay for the study intersections will be summarized by movement and approach as well as for the overall intersection. If necessary, mitigation of impacts will be recommended.
- Intersection analyses will be conducted using the Synchro software for existing conditions, future conditions without the project, and future conditions with the proposed project in place. The Highway Capacity Manual (HCM) 6th or 2000 Edition will be used, as applicable. Synchro files will be provided as part of the traffic study.
- A parking description (required vs provided) will be documented in the traffic study.
- The traffic study will include a multimodal section addressing non-automobile modes of transportation. Pedestrian features located near the site, such as sidewalks, crosswalks, ramps to access crosswalks, etc. will be documented.
- Transit routes traveling along Alton Road and Dade Boulevard will be documented. The locations of bus stops and proximity to the project will also be addressed in the traffic study.
- The results of the traffic impact analysis will be documented in a technical report with an executive summary. All traffic data obtained for this project will be included in the Appendix of the traffic study.
- Delivery vehicles will be addressed in the traffic study.
- AutoTURN analyses will be provided as part of the submittal package.
- Entry gates queuing will be addressed if gates for inbound vehicles are proposed.

- The updated traffic study will be consistent with the previously approved traffic report.
- The buildout year for the project is anticipated to be the end of 2026.

TABLE 1
Trip Generation Summary (Proposed Uses)
1901 Alton

Land Use	Size	Daily Trips	AM Peak Hour			PM Peak Hour		
			Total Trips	Inbound	Outbound	Total Trips	Inbound	Outbound
Supermarket (LUC 850)	34,953 sf	3,454	101	60	41	314	157	157
Walk in Bank (LUC 911)	3,908 sf	n/a	n/a	n/a	n/a	48	21	27
External Trips		3,454	101	60	41	362	178	184

Source: ITE Trip Generation Manual (11th Edition)



ATTACHMENT A
Site Plan for 1901 Alton

DESIGN REVIEW BOARD
1901 ALTON ROAD

FINAL SUBMITTAL
 10/09/2023

FILE NO. DRB23-0956

COMMERCIAL PROJECT
 1901 ALTON ROAD MIAMI BEACH, FLORIDA, 33139
 SCOPE OF WORK: NEW CONSTRUCTION OF 4 STORY BUILDING WITH GROUND FLOOR RETAIL AND 3 LEVELS OF PARKING



OPPENHEIM
 ARCHITECTURE



7500 NE 4th Court
 Suite 102
 Miami, FL 33138
 T: (305) 573-2728

PROJECT NUMBER

2314

PROJECT NAME

**WHOLE FOODS
 AND
 WELLS FARGO**
 1901 ALTON ROAD
 MIAMI BEACH, FL 33141

OWNER

CRESCENT HEIGHTS

FACADE ARCHITECT

OPPENHEIM ARCHITECTURE
 AND DESIGN

DRAWING

COVER-DRB



Digitally signed by
 Jennifer McConney
 DN: c=US, o=STUDIO
 MC+G
 ARCHITECTURE,
 dnQualifier=401410
 D00000186945F530E
 0000E32D,
 cn=Jennifer
 McConney
 Date: 2023.10.06
 16:00:59 -04'00'

JENNIFER MCCONNEY FLORIDA LIC# 16000

ALL DRAWINGS AND WRITTEN MATERIAL APPEARING
 HEREIN CONSTITUTE THE ORIGINAL AND UNPUBLISHED
 WORK OF STUDIO MCG ARCHITECTURE AND
 MAY NOT BE DUPLICATED, COPIED OR DISCLOSED
 WITHOUT THE EXPRESS WRITTEN CONSENT OF
 STUDIO MCG ARCHITECTURE & PLANNING, INC. (S) 2020

SCALE:

DRAWN: CV, JDB

CHECK: JMcG

DATE: 10/09/23

SHEET NUMBER

A0.00

MIAMI BEACH

Planning Department, 1700 Convention Center Drive
Miami Beach, Florida 33139, www.miamibeachfl.gov
305.673.7550

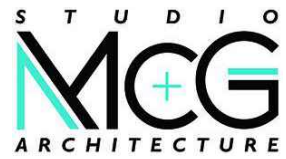

7500 NE 4th Court
Suite 102
Miami, FL 33138
T: (305) 573-2728

ZONING DATA SHEET

INDEX OF DRAWINGS

SHEET #	DESCRIPTION	SUBM1	SUBM2	SUBM3
	SURVEY		•	
A0.00-PB	COVER-PB		•	
A0.01	INDEX OF DRAWINGS AND SITE DATA		•	
A0.02	GROSS AREA DIAGRAMS		•	
A0.03	FAR DIAGRAMS		•	
A0.04	RENDERING VIEW OF SOUTH AND ALTON RD FACADES		•	
A0.07	AERIAL VIEWS		•	
A0.08	EXISTING PHOTOGRAPHY		•	
A0.09	EXISTING PHOTOGRAPHY		•	
A0.10	EXISTING PHOTOGRAPHY		•	
A0.11	EXISTING PHOTOGRAPHY		•	
A0.12	EXISTING PHOTOGRAPHY		•	
A0.13	EXISTING PHOTOGRAPHY		•	
A0.14	EXISTING PHOTOGRAPHY		•	
A0.14.1	EXISTING PHOTOGRAPHY		•	
A0.15	SITE ELEVATIONS		•	
A0.16	SITE ELEVATIONS		•	
A0.17	EXPLODED AXONOMETRIC DIAGRAM		•	
A1.00	SITE PLAN		•	
A1.01	LEVEL 1 FLOOR PLAN		•	
A1.02	LEVEL 1.5 FLOOR PLAN		•	
A1.03	LEVEL 2 FLOOR PLAN		•	
A1.04	LEVEL 3 FLOOR PLAN		•	
A1.05	LEVEL 4 FLOOR PLAN AND ROOF PLAN		•	
A1.06	LOADING DOCK DIAGRAMS		•	
A1.07	DEMO FLOOR PLAN		•	
A2.01	BUILDING ELEVATIONS		•	
A2.02	BUILDING ELEVATIONS		•	
A2.03	BUILDING SECTIONS		•	
A2.10	WALL SECTION		•	
A2.11	WALL SECTION		•	
A2.12	WALL SECTION		•	

ITEM #	Zoning Information	LAND USE: CD-2
1	Address:	1901 Alton Rd, Miami Beach, FL 33139
2	Board and File numbers:	
3	Folio number(s):	02-3234-001-0030
4	Year constructed:	1986
5	Base Flood Elevation:	8'-0" NGVD
		(road elevation to be raised in 2025 per City of Miami Beach)
6	Adjusted grade (Flood+Grade/2)	8'-0"
7	Lot Width	N/A
8	Minimum Unit Size	N/A
9	Existing User	WELLS FARGO
	Proposed Use:	GROCERY STORE MAIN USE, BANK ACCESSORY USE

		Maximum	Existing	Proposed	Deficiencies
10	Height	45'-0"		43'-0"	-
11	Number of Stories	N/A	1	4	-
12	FAR	1	0.00	0.94	-
13	FLOOR AREA Square Footage	55,377 SF	0 SF	52,100 SF	-
14	GROSS Square Footage	N/A	N/A	199,772 SF	-
15	Number of Units Residential	N/A	N/A	N/A	-
16	Number of Units Hotel	N/A	N/A	N/A	-
17	Number of Seats	N/A	N/A	N/A	-
18	Occupancy Load	N/A	N/A	SEE CHART	-

	Setbacks	Required	Existing	Proposed	Deficiencies
	Pedestal (CD-1) COMMERCIAL, LOW INTENSITY DISTRICT				
19	Front Setback (ALTON RD):	0'-0"	N/A	0' - 0"	-
20	Interior side Setback (NE):	10'-0"	N/A	10'-0"	-
21	Rear Setback (E):	10'-0"	N/A	10'-0"	-
22	Side Setback facing Street (NE 19th ST):	0'-0"	N/A	0'-0"	-

	Parking	Required	Existing	Proposed	Deficiencies
23	Parking District (DISTRICT #1) TIER 1	163		277	-
24	Total # of parking spaces required	163	N/A	277	-
25	Parking Space Dimensions	8.5' X 18'	N/A	8.5' X 18'	-
26	Parking Space Configurations (45°, 60°, 90°, Parallel)		N/A	90 DEG	-
27	ADA Spaces		N/A	12	-
28	Tandem Spaces	0	N/A	0	-
29	Drive Aisle Width	22'	N/A	22'	-
30	Valet Drop off and pick up	N/A	N/A	N/A	-
31	Loading zones and Trash collection areas	2	N/A	2	-
32	Bikes (SHORT TERM)	4	N/A	4	-
33	Bikes (LONG TERM)	15	N/A	15	-
34	loading spaces: 3 for 20-40k sf	3	N/A	3	-

35	Is this a contributing building?	NO
36	Located within a Local Historic District?	NO

PARKING REQUIREMENTS				
SPACE	REQUIRED	GROSS AREA/ SEATS	FACTOR	PARKING SPACES
GROCERY STORE	1 SPACE / 250 SF	34,953	250	140
CAFÉ (WITHIN STORE)	1 SPACE / 4 SEATS	60	4	15
BANK	1 SPACE / 400 SF	3,908	400	10
			TOTAL	165
			PROVIDED	277
			EXCESS	-112

PROJECT NUMBER
2314

PROJECT NAME

WHOLE FOODS
AND
WELLS FARGO
1901 ALTON ROAD
MIAMI BEACH, FL 33141

OWNER

CRESCENT HEIGHTS

FACADE ARCHITECT

OPPENHEIM ARCHITECTURE
AND DESIGN

DRAWING

INDEX OF
DRAWINGS
AND SITE
DATA

JENNIFER McCONNIEY FLORIDA LIC# AR93044

ALL DRAWINGS AND WRITTEN MATERIAL APPEARING
HEREIN CONSTITUTE THE ORIGINAL AND UNPUBLISHED
WORK OF STUDIO MCG ARCHITECTURE AND
MAY NOT BE DUPLICATED, USED OR DISCLOSED
WITHOUT THE EXPRESS WRITTEN CONSENT OF
STUDIO MCG ARCHITECTURE & PLANNING, INC. (c) 2020

SCALE: 1/4" = 1'-0"

DRAWN: CV, JDB

CHECK: JMcG

DATE: 10/09/23

SHEET NUMBER

A0.01

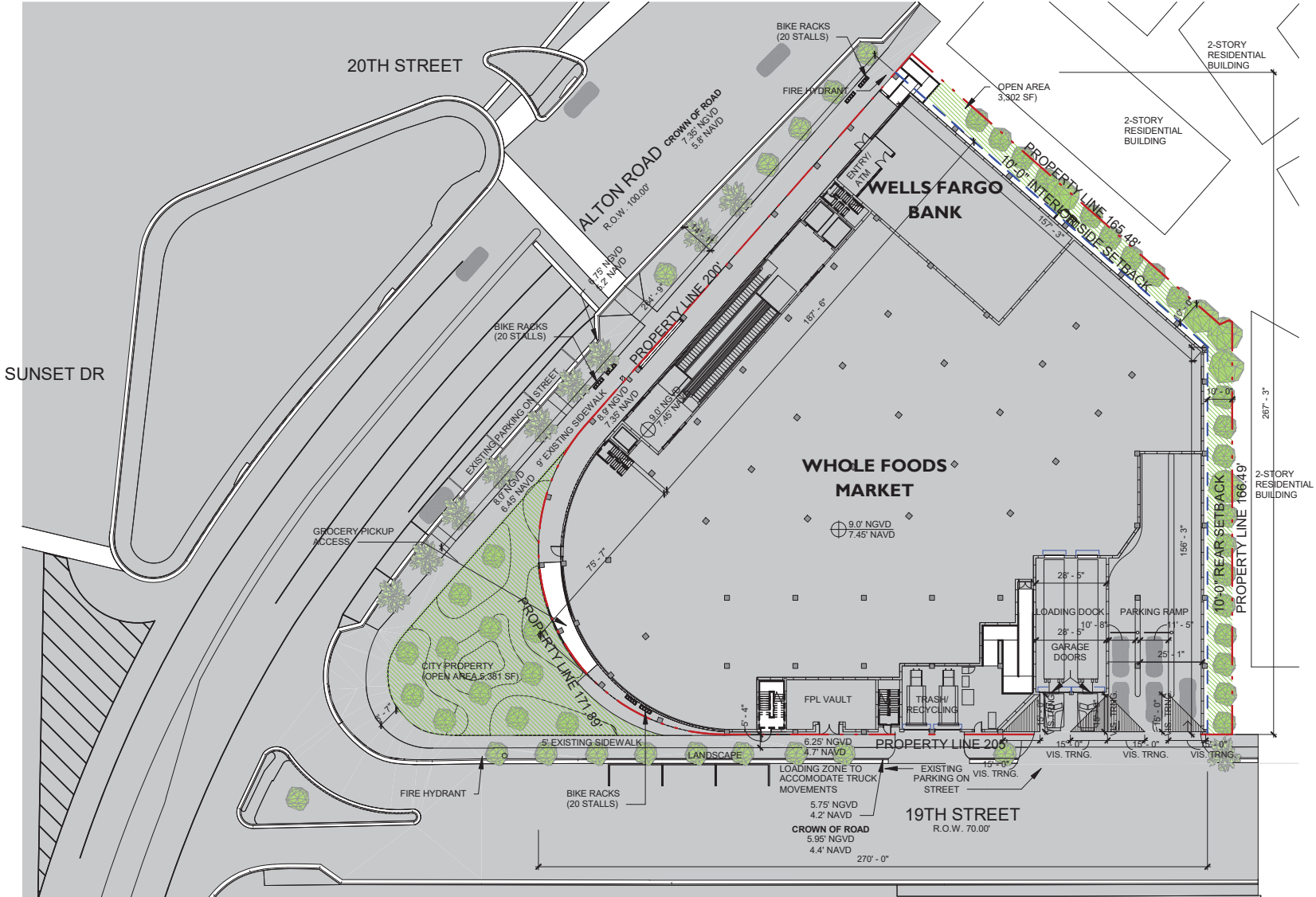

WALGREENS



1

SITE PLAN
1" = 40'-0"

PROJECT NAME
**WHOLE FOODS
 AND
 WELLS FARGO**
 1901 ALTON ROAD
 MIAMI BEACH, FL 33141

OWNER
CRESCENT HEIGHTS

FACADE ARCHITECT
**OPPENHEIM ARCHITECTURE
 AND DESIGN**

DRAWING

**LEVEL 1
 FLOOR PLAN**

SCALE: 1/32" = 1'-0"
 DRAWN: CV, JDB
 CHECK: JMG
 DATE: 10/09/23
 SHEET NUMBER
A1.01

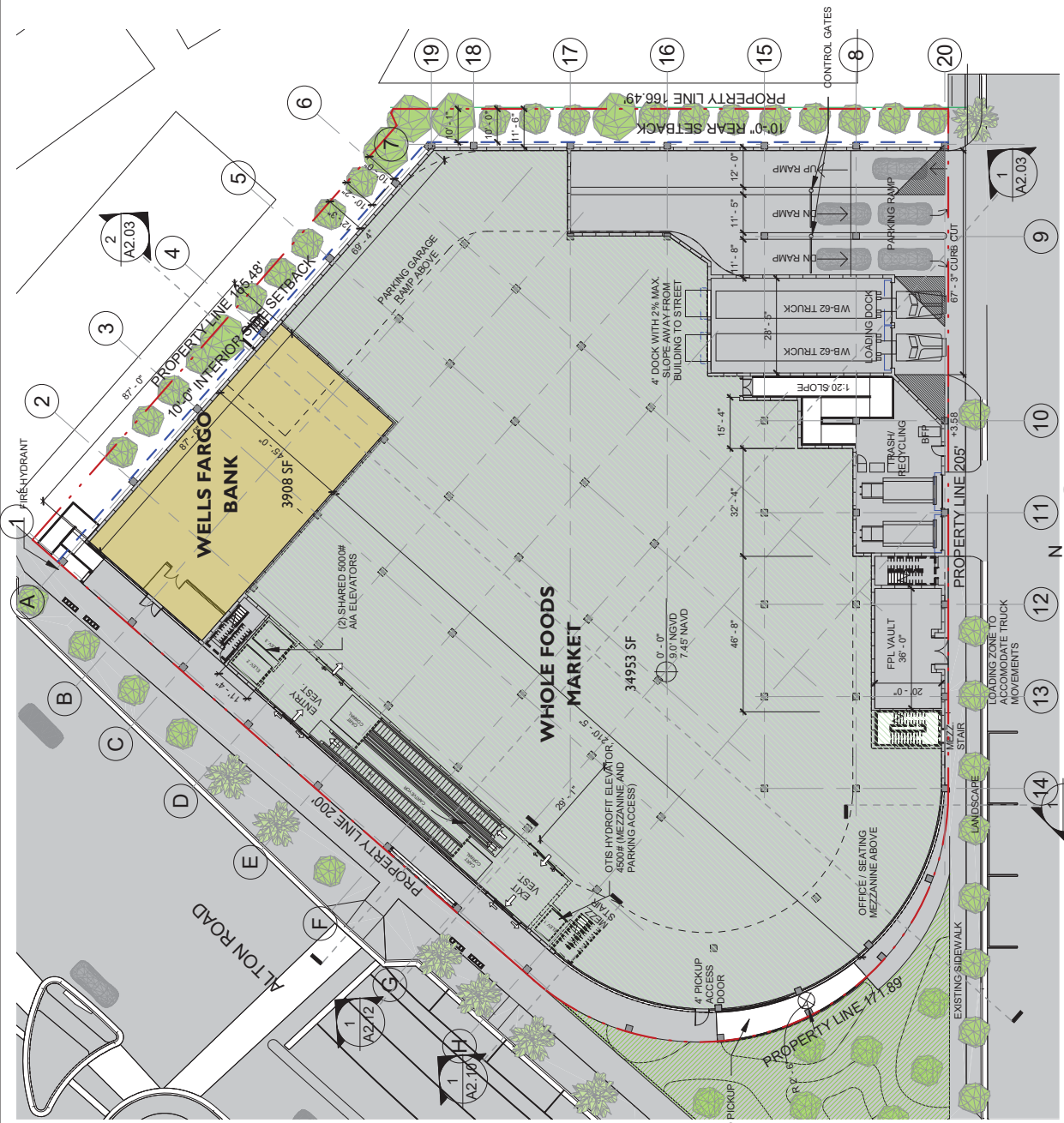

LEVEL 1 FLOOR PLAN
 1/32" = 1'-0"

Parking Schedule		
Level	Comments	Count
L2	PARKING ON STREET	3
L2	PARKING 1 CAR TYP.	79
L2	PARKING SINGLE ADA	4
L3	PARKING 1 CAR TYP.	85
L3	PARKING SINGLE ADA	6
L4	PARKING 1 CAR TYP.	96
L4	PARKING SINGLE ADA	4

277

DISSEMINATION AND/OR REPRODUCTION OF THIS DOCUMENT WITHOUT THE WRITTEN PERMISSION OF MCGG ARCHITECTURE IS STRICTLY PROHIBITED. ANY NOT IN COMPLIANCE WITH THE AIA CODE OF ETHICS SHALL BE CONSIDERED A VIOLATION. MCGG ARCHITECTURE & PLANNING, INC. 03/2022

ATTACHMENT B

Responses to Traffic Methodology



MEMORANDUM

To: Otniel Rodriguez, E.I.
City of Miami Beach

From: Adrian K. Dabkowski, P.E., PTOE 

Date: July 28, 2023

Subject: 1901 Alton Road
Traffic Study Review Comments

Per your request, we have completed our review of the subject submittal. We offer the following comments:

1. As discussed in the methodology meeting, a traffic impact analysis was previously prepared and approved for this project. Therefore, the study area intersections should be consistent with the previously approved traffic study. A copy of the previously approved study should be included as an attachment to the methodology.
2. Provide maneuverability analysis for parking garage, loading areas, and refuse pick-up as part of the traffic study.
3. Provide entry gate analysis, if entry gate will be provided.
4. Include 1920 Alton Road as a committed development and 1910 Alton Road if it has yet to receive its certificate of occupancy.

k:\ftl_tpto\040223301 comb study review\1901 alton road\2023 07 - 1901 alton - methodology comments.docx

Response 1: The updated traffic study will be consistent with the previously approved traffic study. A copy of the previous traffic study is attached.

Response2: AutoTURN analyses will be provided as part of the submittal package.

Response 3: If entry gates are provided, a queuing analysis will be provided.

Response 4: The 1920 Alton project trips will be included as committed development trips.

1901 Alton (Whole Foods) Miami Beach, Florida

traffic study

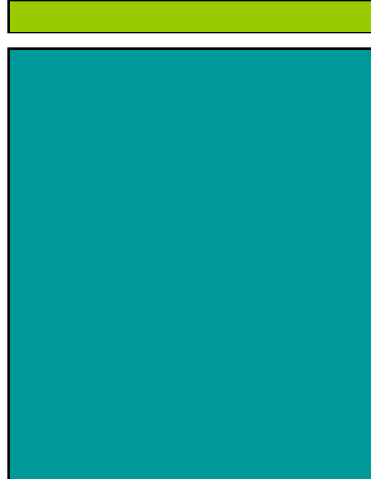

prepared for:
Crescent Heights

Traf Tech
ENGINEERING, INC.

March 31, 2015

March 31, 2015

Mr. Graham Penn
Bercow Radell & Fernandez, P.A.
200 S. Biscayne Boulevard, Suite 850
Miami, Florida 33131

Re: 1901 Alton (Whole Foods) – Updated Traffic Study

Dear Mr. Penn:

Traf Tech Engineering, Inc. is pleased to provide you with the results of the traffic study undertaken for the proposed 1901 Alton (Whole Foods) project planned to be located at 1901 Alton Road in Miami Beach, Florida. The study addresses the traffic impacts created by the proposed project to the surrounding street system.

It has been a pleasure working with you on this project.

Sincerely,

TRAF TECH ENGINEERING, INC.

Joaquin E. Vargas, P.E.
Senior Transportation Engineer

TABLE OF CONTENTS

INTRODUCTION	1
INVENTORY	3
Existing Land Use	3
Proposed Land Uses and Access.....	3
EXISTING CONDITIONS	4
Roadway System.....	4
Nearby Intersections	4
TRAFFIC COUNTS	6
TRIP GENERATION	8
TRIP DISTRIBUTION AND TRAFFIC ASSIGNMENT	10
TRAFFIC ANALYSES	12
Future Conditions Traffic Volumes	12
Level of Service Analyses	13
Access Driveway	13
CONCLUSIONS AND RECOMMENDATIONS	17

LIST OF FIGURES

FIGURE 1 – Project Location Map	2
FIGURE 2 – Existing Lane Geometry	5
FIGURE 3 – Existing Traffic Counts – Peak Hour (March 2011 and January 2012).....	7
FIGURE 4 – New Project Traffic Assignment.....	11
FIGURE 5 – Background Traffic (Year 2016).....	14
FIGURE 6 – Total Traffic with Project (Year 2016)	15

LIST OF TABLES

TABLE 1 – Trip Generation Summary (1901 Alton)	8
TABLE 2 – Project Trip Distribution.....	10
TABLE 3 – Signalized Intersection Capacity/LOS Analyses	16
TABLE 4 – Stop Control Intersections Capacity/LOS Analyses	16

INTRODUCTION

1901 Alton (Whole Foods) is a proposed supermarket and bank development planned to be located on the east side of Alton Road just north of 19th Street (1901 Alton Road) in the City of Miami Beach in Miami-Dade County, Florida. The location of the project site is illustrated in Figure 1 on the following page.

Traf Tech Engineering, Inc. was retained by Crescent Heights to conduct a traffic study¹ in connection with the proposed development. The study addresses trip generation and the traffic impacts created by the proposed project on the nearby transportation network. This study is divided into seven (7) sections, as listed below:

1. Inventory
2. Existing Conditions
3. Traffic Counts
4. Trip Generation
5. Trip Distribution and Traffic Assignment
6. Traffic Impact Analysis
7. Conclusions and Recommendations

¹ The traffic methodology was discussed and agreed with the City of Miami Beach staff.

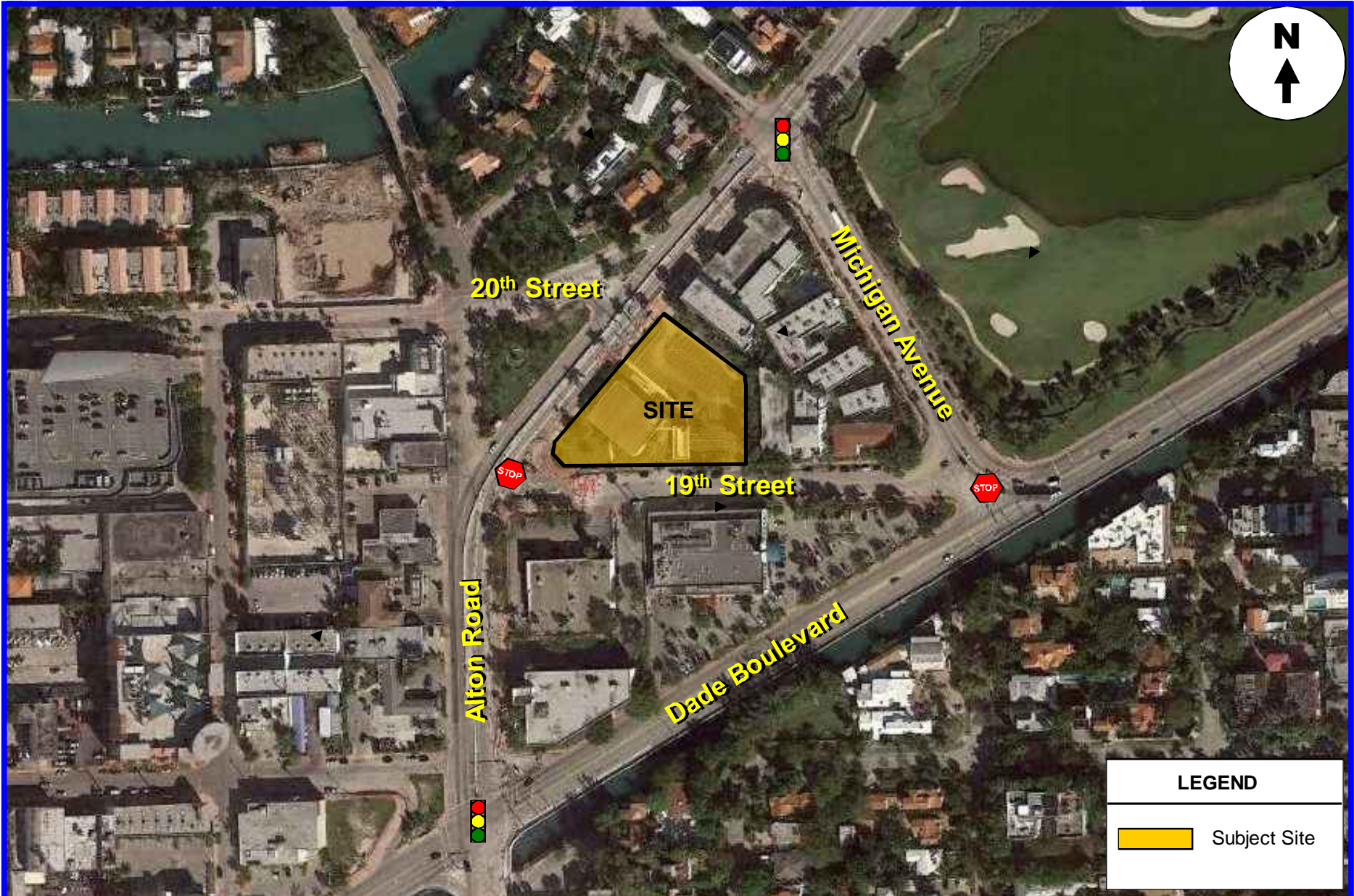

Traf Tech
ENGINEERING, INC.

PROJECT LOCATION MAP

FIGURE 1
191 Alton
Miami Beach, Florida

INVENTORY

Existing Land Use

Bank and parking lot

Proposed Land Uses and Access

The 1901 Alton project consists of the following land use and intensity:

- 49,328 square foot Supermarket
- 4,490 square foot Drive-in Bank

The access to the project's proposed parking garage will consist of the following:

- Full access driveway off of 19th Street

Additionally, the parking garage will provide a total of 363 parking spaces plus 3,489 square foot of loading space. Appendix A contains a copy of the proposed site plan for the project site.

EXISTING CONDITIONS

This section addresses the existing roadway system located in the vicinity of the project site and nearby intersections.

Roadway System

The roadway system located near the project site includes Alton Road, Michigan Avenue, 20th Street, 19th Street, and Dade Avenue. Near the project site, Alton Road, Michigan Avenue, and Dade Avenue are four-lane facilities, while 20th Street and 19th Street, are two-lane facilities.

Nearby Intersections

With the assistance of City of Miami Beach staff, four intersections (plus the future access driveway) were identified as the locations that will be impacted the most by the proposed project. These intersections include Alton Road and Michigan Avenue, Alton Road and 19th Street, Alton Road and Dade Boulevard, and 19th Street and Michigan Avenue. The two intersections of 19th Street are controlled with a stop sign and the remaining intersections are signalized.

Figure 2 shows the existing lane geometry of the four intersections selected for analysis purposes. The number of lanes on the street system surrounding the project site is also depicted in the figure.

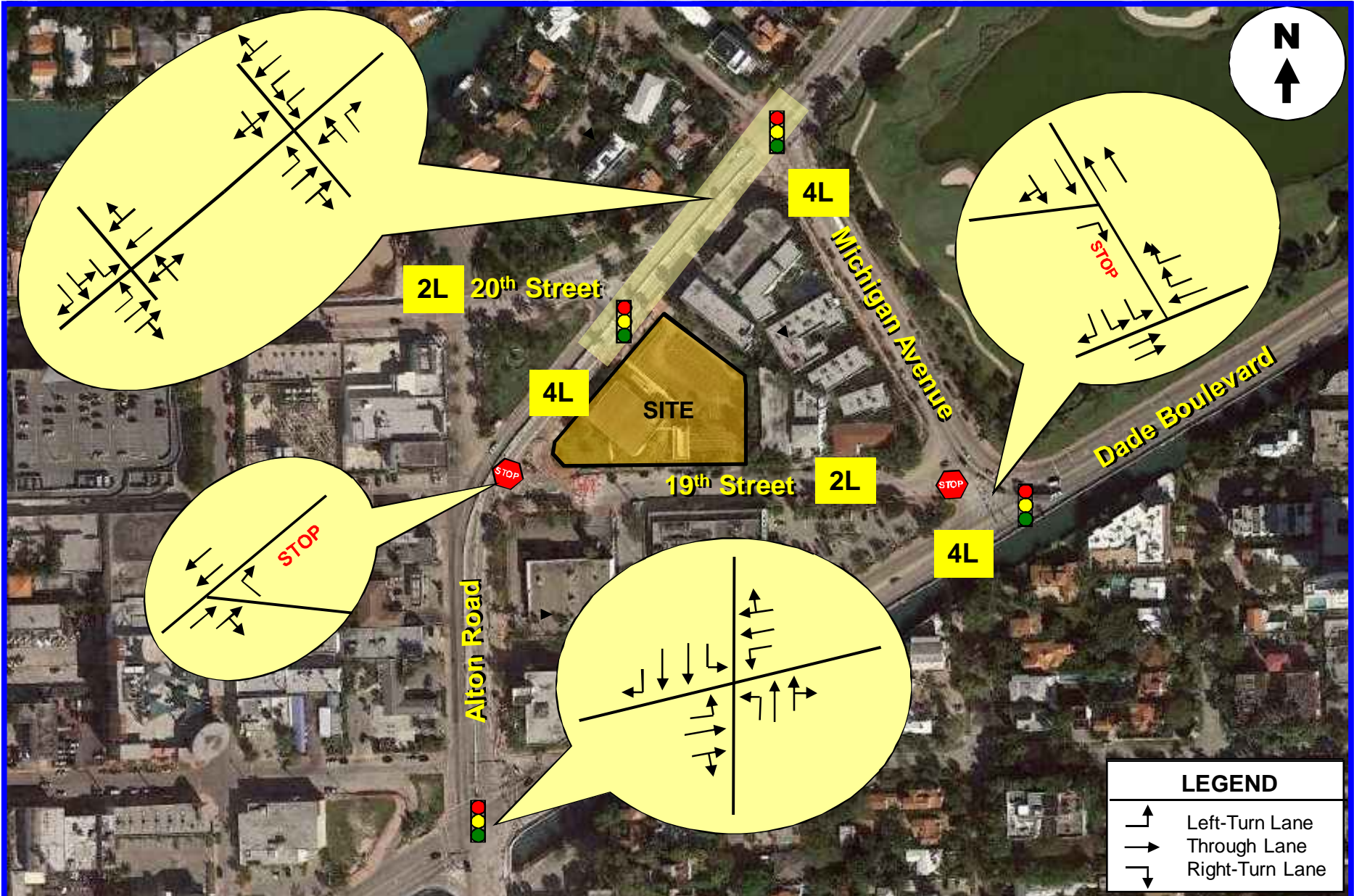

TRAFFIC COUNTS

Traffic counts were obtained from studies conducted by FDOT since traffic patterns are currently altered due to the construction of Alton Road.

The obtained TMCs were performed on a typical weekday and collected during the PM peak periods (3:30 PM to 5:30 PM and 4:00 PM to 6:00 PM) established based on 72-hour Automated Traffic Recorders. The TMCs were collected on March 29, 30, and 31, 2011 and on January 27, 2012 at the following four intersections located near the project site:

1. Alton Road and Michigan Avenue (signalized intersection)
2. Alton Road and 19th Street (stop controlled)
3. Alton Road and Dade Avenue (signalized intersection)
4. 19th Street and Michigan Avenue (stop controlled)

Figure 3 summarizes the results of the intersection turning movement counts undertaken during the weekday peak hour. Appendix B contains the intersection turning movement counts, as collected in the field. The signal timing plan for the signalized intersections of Alton Road and Michigan Avenue, and Alton Road and Dade Avenue were obtained from the Miami-Dade County's web site.

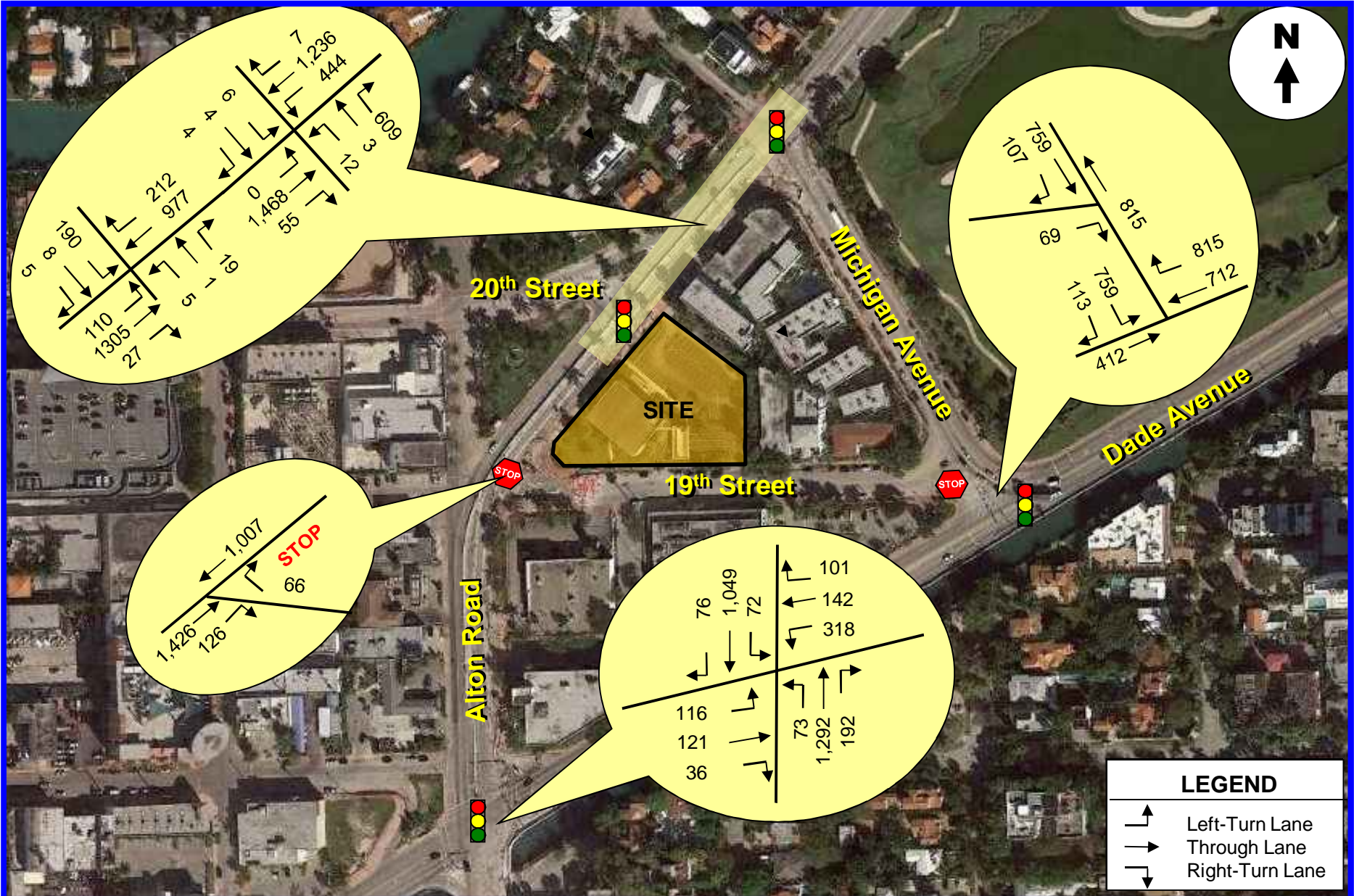

TRIP GENERATION

The trip generation for the project was based on information contained in the Institute of Transportation Engineer’s (ITE) *Trip Generation Manual* (9th Edition). According to the subject ITE manual, the most appropriate “land use” categories for the proposed land uses includes Land Use 850 – Supermarket and Land Use 912 – Drive-in Bank. Table 1 summarizes the external trips associated with the proposed 1901 Alton development.

TABLE 1					
Trip Generation Summary					
1901 Alton (Proposed Land Use)					
Land Use	Size	Daily Trips	Weekday Peak Hour Trips		
			Inbound	Outbound	Total
PROPOSED USES					
Supermarket	49,328 sf	4,694	236	226	462
Drive-in Bank	4,490 sf	665	55	54	109
Total	-	5,359	291	280	571

Source: ITE Trip Generation Manual (9th Edition)

As indicated in Table 1, the external trips anticipated to be generated by the proposed 1901 Alton project consist of approximately 5,359 daily trips and approximately 571 trips (291 inbound and 280 outbound) during the typical PM peak hour. In order to assess impacts with a conservative approach, no deductions were made to account for trips associated with the existing land use (bank and parking lot), internal trips, and passer-by traffic. The trip generation rates used to determine the trips associated with the proposed uses are presented below:

ITE Land Use 850 – Supermarket

Daily Trips

$$T = 66.95 (X) + 1391.56$$

Where T = number of weekday daily trips and

X = 1000 Sq feet gross floor area

PM Peak Hour of Adjacent Street (Typical Afternoon Rush Hour)

$$\ln(T) = 0.74 \ln(X) + 3.25 \text{ (51\% inbound and 49\% outbound)}$$

Where T = average PM peak hour vehicle trip ends and

X = 1000 Sq feet gross floor area

ITE Land Use 912 – Drive-in Bank

Daily Trips

$$T = 148.15 (X)$$

Where T = number of weekday daily trips and

X = 1000 Sq feet gross floor area

PM Peak Hour of Adjacent Street (Typical Afternoon Rush Hour)

$$T = 24.30 (X) \text{ (50\% inbound and 50\% outbound)}$$

Where T = average AM peak hour vehicle trip ends and

X = 1000 Sq feet gross floor area

TRIP DISTRUBUTION AND TRAFFIC ASSIGNMENT

The trip distribution and traffic assignment for the project were based on Miami-Dade County's Cardinal Distribution information for the study area. Table 2 summarizes the County's cardinal distribution data for Traffic Analysis Zone 617, which is applicable to the project site from the latest SERPM data published by Miami-Dade County.

TABLE 2		
Project Trip Distribution		
1901 Alton		
Direction		% of Total Trips
North:	Northwest	9.99%
	Northeast	0%
South:	Southwest	0%
	Southeast	0%
East:	Northeast	28.84%
	Southeast	24.92%
West:	Northwest	10.92%
	Southwest	25.33%
Total		100.00%

Source: Miami-Dade County (2035 SERPM)

Based on the above, the following traffic assignment was assumed for the proposed development:

- 20% to and from the north via Alton Road
- 20% to and from the north via Dade Boulevard
- 5% to and from the west via Michigan Avenue
- 5% to and from the west via 20th Street
- 30% to and from the south north via Alton Road
- 20% to and from the south via Dade Boulevard

The new peak hour traffic generated by the project was assigned to the nearby transportation network using the traffic assignment documented above. The new project traffic assignment is summarized in Figure 4.

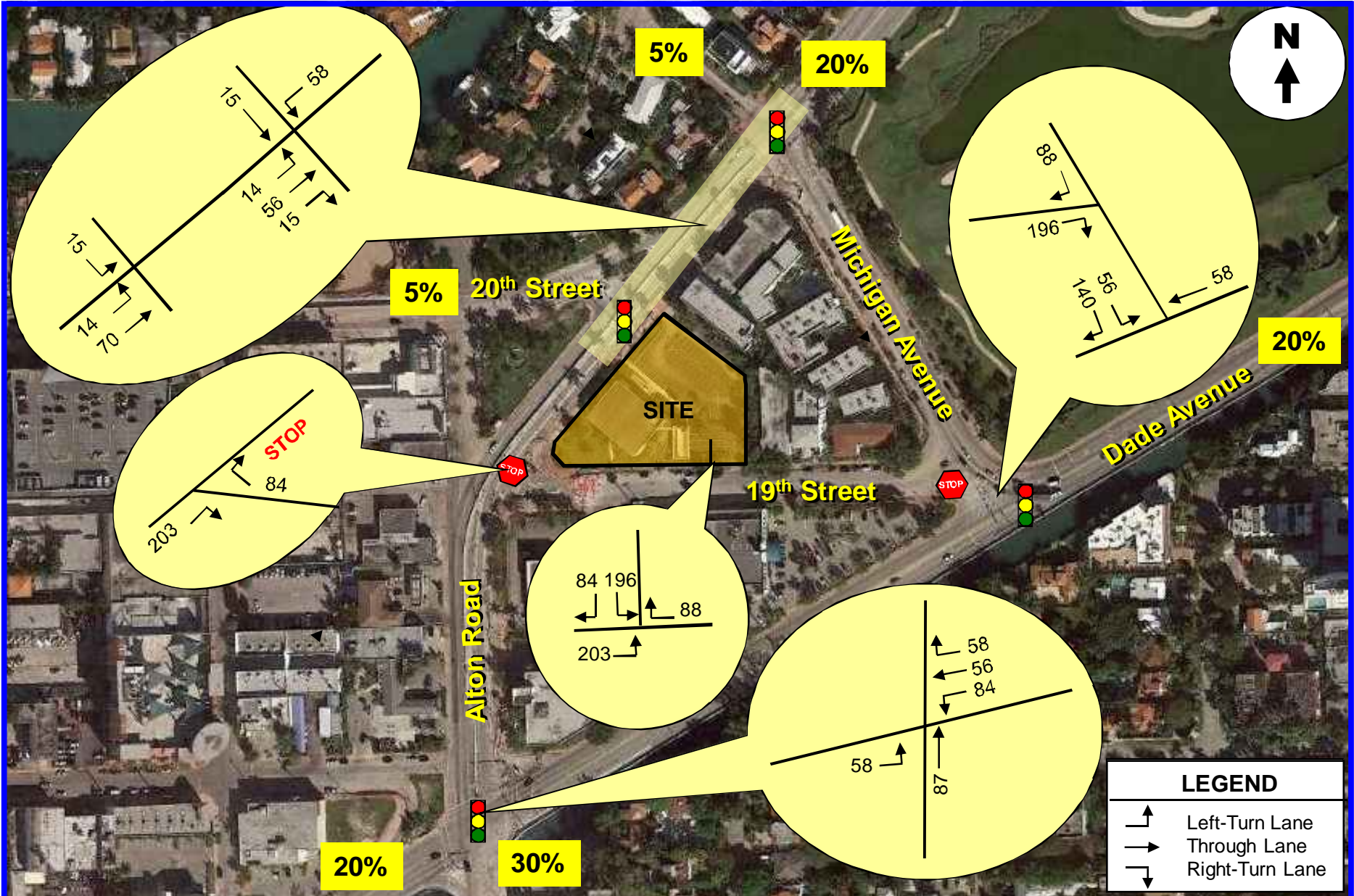

TRAFFIC ANALYSIS

This section of the study is divided into three parts. The first part consists of developing the future conditions traffic volumes for the study area. The second part includes level-of-service analyses for existing and future conditions. The third section addresses the projected operating conditions of the project's access driveway.

Future Conditions Traffic Volumes

Two sets of future traffic volumes were developed. The first set includes project buildout conditions without the proposed project and the second set adds the new trips anticipated to be generated by the project.

In order to develop year 2016 traffic volumes (project anticipated to be built and occupied by the year 2016), without the proposed project, two separate analyses were undertaken. The first analysis converts the existing peak hour traffic counts collected in the field during the month of March to average peak season conditions. Based on the 2013 FDOT's Peak Season Factor Category report, factors of 1.00 and 1.03 are required to convert traffic counts collected in March of 2011 and January 2012 to average peak season conditions (refer to Appendix C). Moreover, a growth factor of 1% was applied to project 2011 and 2012 peak season traffic volumes to year 2014. The second analysis includes a growth factor to project 2014 peak season traffic volumes to year 2016. Based on traffic growth data published by the FDOT for a nearby traffic count station, minimal traffic growth has occurred during the past five years (refer to Appendix C). However, in order to assess impacts with a conservative approach, and to account for unforeseen approved projects (committed trips) that may impact the study intersections, a one percent (1%) growth rate was used for purposes of this study.

The new trips generated by the 1901 Alton project (refer to Figure 4) were added to the 2016 background traffic in order to develop total traffic conditions. The future traffic projections for the study intersections (peak season adjustments, growth rates, committed development trips and project traffic) are presented in tabular format in Appendix E. Figures 5 and 6 present the year 2016 future traffic volumes for the study area.

Figure 5 includes background traffic only (without the proposed project) and Figure 6 includes the additional traffic anticipated to be generated by the 1901 Alton project.

Level of Service Analyses

Intersection capacity/level of service analyses were conducted for the four study intersections and the access driveway. The analyses were undertaken following the capacity/level of service procedures outlined in the Highway Capacity Manual (HCS) using the SYNCHRO software.

Please note that this study will account for the future implementation of the southbound dual left-turn lanes at Alton Road and Michigan Avenue, as currently being pursued by FDOT.

The results of the capacity analyses are summarized in Tables 3 and 4. As indicated in Tables 3 and 4, all study intersections are currently operating adequately and will continue to operate at a acceptable level of service in the year 2016 with the proposed project in place, with two exceptions (the intersections of Alton Road/Dade Boulevard and Alton Road at 19th Street (westbound approach)).

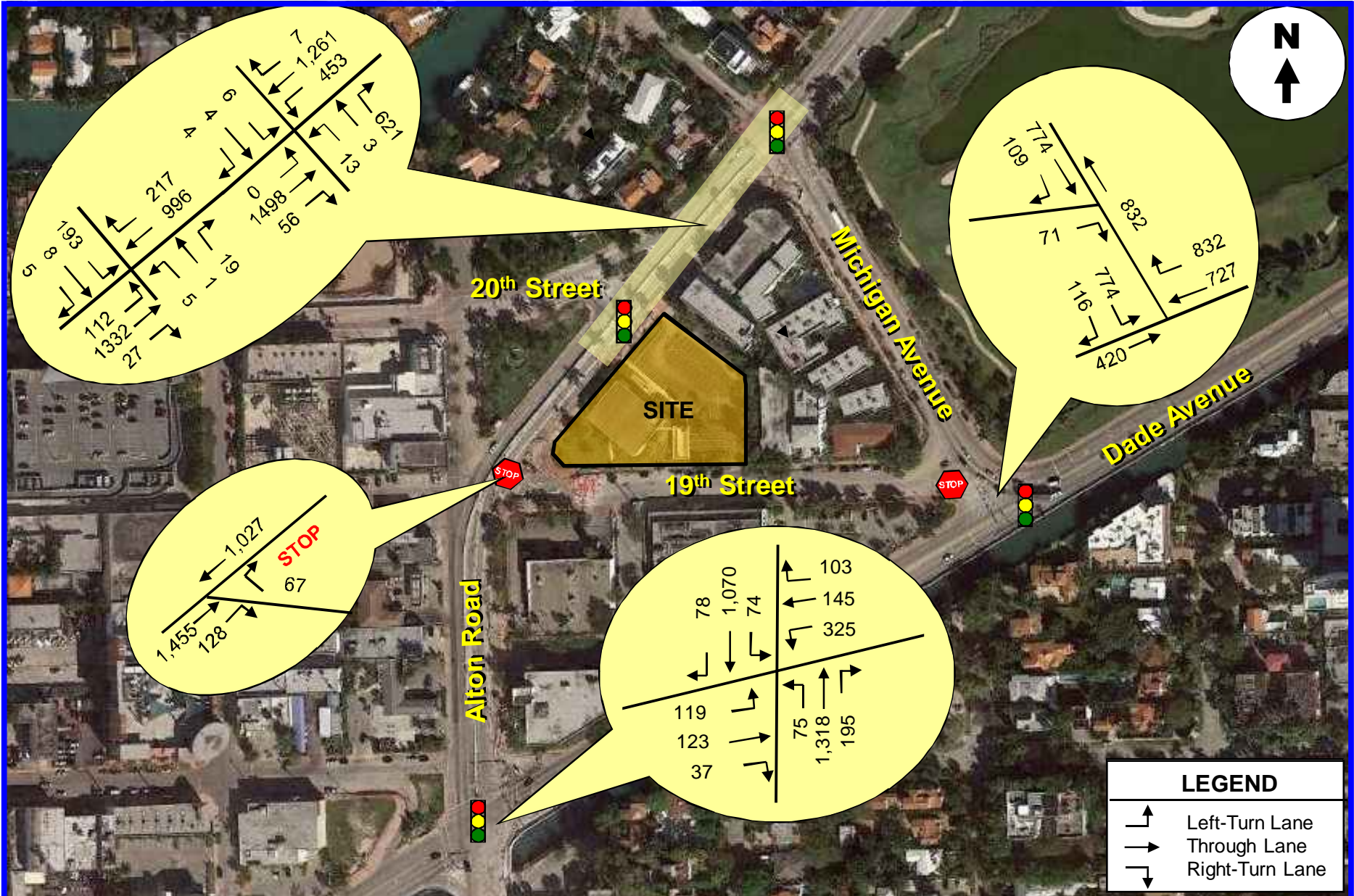



With signal timing optimization the delay at the Alton Road/Dade Boulevard intersection can be improved by approximately 10%. Hence, coordination with Miami-Dade County is recommended after this project is built and occupied. In order to improve the Alton Road/19th Street intersection, multi-modal improvements, such as bicycle racks, car-pool parking, transit bus passes for employees, etc. should be considered for this project.

Access Driveway (19th Street)

The project access driveway is projected to operate at level of service “C” (refer to Table 4).

TABLE 3 Intersection Level of Service – (Signalized Intersections) 1901 Alton			
Intersection	2014 Existing	Future Traffic Conditions	
		2016 w/o Project	2016 With Project
Alton Rd & Michigan Ave	D	C	D
Alton Rd & Dade Ave	D	D	E
Dade Ave & Michigan Ave	B	B	C

Source: *Highway Capacity Manual*

TABLE 4 Intersection Level of Service (Stop-Control Intersections) 1901 Alton			
Intersection/Movement	2014 Existing	Future Traffic Conditions	
		2016 w/o Project	2016 With Project
Alton Rd & 19 th St (WB)	C	C	E
19 th & Michigan (EB)	B	B	C
19 th & Driveway (Exit)	-	-	D

Source: *Highway Capacity Manual*

The computer printouts of the intersection capacity analyses are contained in Appendix F.

CONCLUSIONS AND RECOMMENDATIONS

1901 Alton (Whole Foods) is a proposed development planned to be located at 1901 Alton Road in the City of Miami Beach in Miami-Dade County, Florida.

The project site is currently occupied by a Bank with a parking lot.

The 1901 Alton project consists of the following land use and intensity:

- 49,328 square foot Supermarket
- 4,490 square foot Drive-in Bank

The access to the project's proposed parking garage will consist of the following:

- Full access driveway off of 19th Street.

Additionally, the parking garage will provide a total of 363 parking spaces plus 3,489 square foot of loading space.

Traf Tech Engineering, Inc. was retained by Crescent Heights to conduct a traffic study in connection with the proposed 1901 Alton development. The study addresses trip generation and the traffic impacts created by the proposed project on the nearby transportation network. The conclusions and recommendations of the traffic study are presented below:

- The external trips anticipated to be generated by the proposed 1901 Alton project consist of approximately 5,359 daily trips and approximately 571 trips (291 inbound and 280 outbound) during the typical PM peak hour. In order to assess impacts with a conservative approach, no deductions were made to account for trips associated with the existing land use (bank and parking lot), internal trips, and passer-by traffic.

-
- All study intersections are currently operating adequately and will continue to operate at an acceptable level of service in the year 2016 with the proposed project in place with two exceptions (the intersections of Alton Road/Dade Boulevard and Alton Road at 19th Street).
 - With signal timing optimization the delay at the Alton Road/Dade Boulevard intersection can be improved by approximately 10%. Hence, coordination with Miami-Dade County is recommended after this project is built and occupied. In order to improve the Alton Road/19th Street intersection, multi-modal improvements, such as bicycle racks, preferential car-pool parking, transit bus passes for employees, etc. should be considered for this project.
 - The project access driveway is projected to operate at level of service “B”.

APPENDIX A

Site Plan – 1901 Alton (Whole Foods)

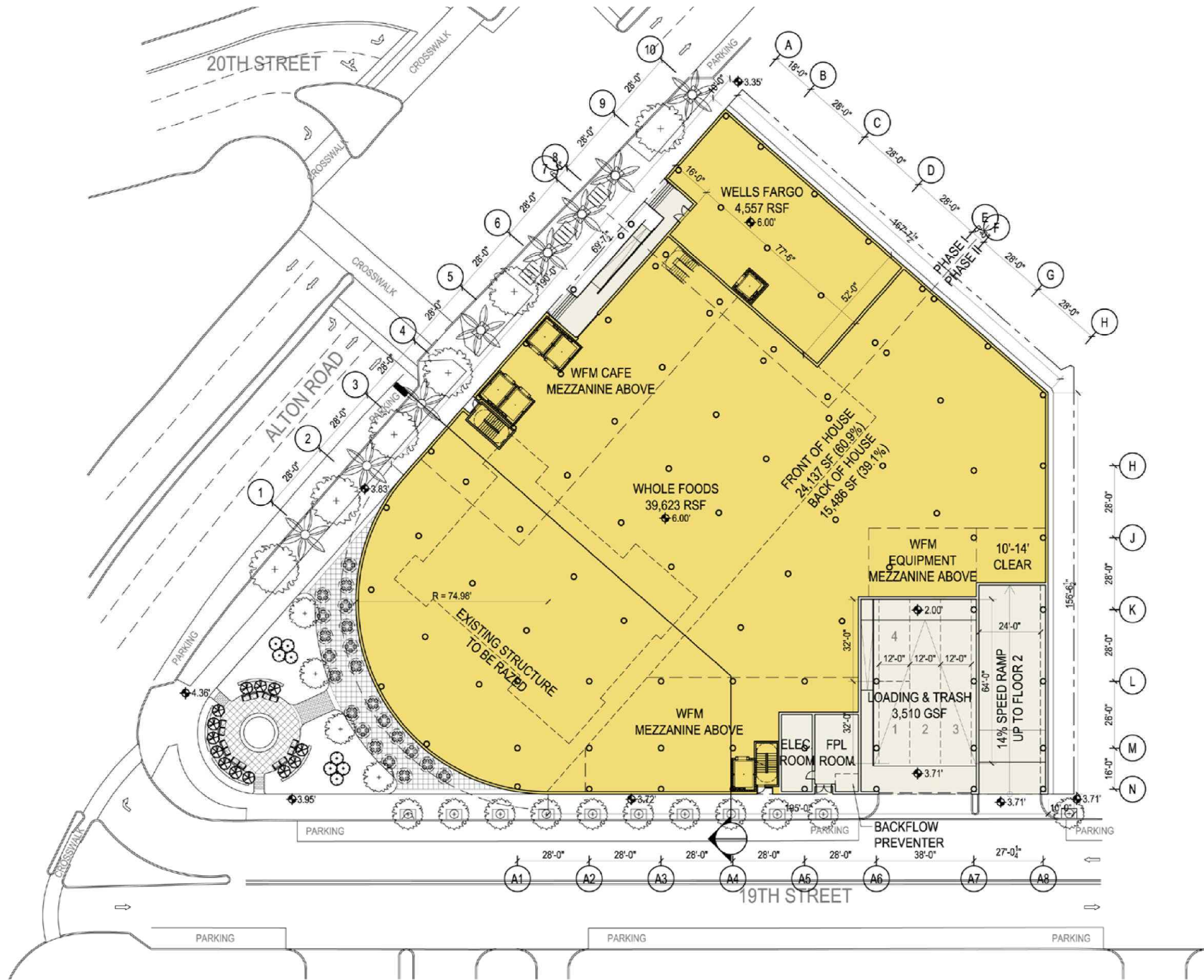

BUILT AREA

FAR AREA

1901 ALTON RD

CRESCENT HEIGHTS

ANTUNOVICH ASSOCIATES
ARCHITECTURE · PLANNING · INTERIOR DESIGN

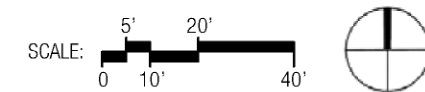

First Floor Plan | 8

Miami Beach, FLORIDA | December 8, 2014

APPENDIX B

Traffic Counts and Signal Timing Data



TOD Schedule Report for 2648: Alton Rd&Dade Blvd

Active Phase Bank: Phase Bank

Phase	Walk			Don't Walk	Min Initial	Veh Ext			Max Limit	Max 2			Yellow	Red
	1	2	3			1	2	3		1	2	3		
1	0	0	0	0	0	0	0	0	0	0	0	0	0	0
2	7	7	7	19	19	19	1	1	1	30	45	30	0	30
3	0	0	0	0	0	0	2	2	2	5	5	8	13	5
4	7	7	7	32	32	32	2.5	2.5	2.5	12	32	20	33	32
5	0	0	0	0	0	0	2	2	2	5	7	8	14	5
6	7	7	7	19	19	19	1	1	1	30	45	30	0	30
7	0	0	0	0	0	0	2	2	2	8	5	8	13	5
8	7	7	7	32	32	32	2.5	2.5	2.5	12	32	20	33	32

Last In Service Date:

Permitted Phases	
Default	12345678
External Permit 0	12345678
External Permit 1	-2-456-8
External Permit 2	-2-456-8

Current TOD Schedule	Plan	Green Time								Ring_Offset	Offset
		1	2	3	4	5	6	7	8		
1	160	7	97	8	32	7	95	8	32	0	133
2	160	5	102	5	32	5	100	5	32	0	138
3	120	10	50	12	32	10	48	12	32	0	106
4	130	14	56	12	32	14	54	12	32	0	3
5	130	10	60	12	32	10	58	12	32	0	119
6	130	10	60	12	32	10	58	12	32	0	65
7	105	7	44	6	32	7	42	6	32	0	28
8	120	11	49	12	32	11	47	12	32	0	116
9	120	7	57	8	32	7	55	8	32	0	87
10	130	10	60	12	32	10	58	12	32	0	70
13	105	10	39	8	32	10	37	8	32	0	69
14	105	10	39	8	32	10	37	8	32	0	68
15	130	10	64	8	32	10	62	8	32	0	124
16	130	10	60	12	32	10	58	12	32	0	70
17	130	10	60	12	32	10	58	12	32	0	65
18	90	5	32	5	32	5	30	5	32	0	66
19	90	5	44	5	20	5	42	5	20	0	76
20	130	10	60	12	32	10	58	12	32	0	120
23	90	5	32	5	32	5	30	5	32	0	64

Local TOD Schedule		
Time	Plan	DOW
0000	8	Su M T W Th S
0000	Free	F
0030	Free	Su
0600	8	Su M T W Th F S
0800	7	Su
0800	5	M T W Th F
1000	4	Su
1030	4	S
1515	16	M T W Th F
1615	6	M T W Th F
1830	4	Su M T W Th F S
2000	8	Su M T W Th F S
2330	Free	M T W Th

TOD Schedule Report for 2648: Alton Rd&Dade Blvd

Current Time of Day Function

<u>Time</u>	<u>Function</u>	<u>Settings *</u>	<u>Day of Week</u>
0000	TOD OUTPUTS	-----	Su M T W Th S
0030	TOD OUTPUTS	-----2-	M T W Th
0600	TOD OUTPUTS	-----	Su M T W Th F S
2330	TOD OUTPUTS	-----2-	M T W Th

Local Time of Day Function

<u>Time</u>	<u>Function</u>	<u>Settings *</u>	<u>Day of Week</u>
0000	TOD OUTPUTS	-----	Su M T W Th S
0000	TOD OUTPUTS	-----2-	F
0030	TOD OUTPUTS	-----1	Su
0030	TOD OUTPUTS	-----2-	M T W Th
0600	TOD OUTPUTS	-----	Su M T W Th F S
2330	TOD OUTPUTS	-----2-	M T W Th

*** Settings**

- Blank - FREE - Phase Bank 1, Max 1
- Blank - Plan - Phase Bank 1, Max 2
- 1 - Phase Bank 2, Max 1
- 2 - Phase Bank 2, Max 2
- 3 - Phase Bank 3, Max 1
- 4 - Phase Bank 3, Max 2
- 5 - EXTERNAL PERMIT 1
- 6 - EXTERNAL PERMIT 2
- 7 - X-PED OMIT
- 8 - TBA



TOD Schedule Report for 3276: Alton Rd&20 St

Active Phase Bank: Phase Bank 1

Phase	Walk			Don't Walk	Min Initial			Veh Ext			Max Limit			Max 2			Yellow	Red		
	1	2	3		1	2	3	1	2	3	1	2	3	1	2	3				
1	0	0	0	0	0	0	5	5	5	2	2	2	5	5	9	12	5	0	3	0
2	5	5	5	19	19	19	7	7	7	1	1	1	40	63	40	0	63	0	4	1.5
3	5	5	5	19	19	19	7	7	7	2.5	2.5	2.5	12	27	30	22	27	0	4	1.3
4	0	0	0	0	0	0	7	7	7	2.5	2.5	2.5	9	14	20	14	15	0	4	1.3
5	0	0	0	0	0	0	0	0	0	0	0	0	0	0	0	0	0	0	0	0
6	5	5	5	19	19	19	7	7	7	1	1	1	40	63	40	0	63	0	4	1.5
7	0	0	0	0	0	0	0	0	0	0	0	0	0	0	0	0	0	0	0	0
8	0	0	0	0	0	0	0	0	0	0	0	0	0	0	0	0	0	0	0	0

Last In Service Date: unknown

Permitted Phases

Default	12345678
External Permit 0	1234-6--
External Permit 1	-234-6--
External Permit 2	-234-6--

Current TOD Schedule	Plan	Green Time								Ring_Offset	Offset	
		1	2	3	4	5	6	7	8			
1	NBL	160	11	95	27	8	0	109	0	0	0	11
3	SBT	120	10	55	27	9	0	68	0	0	0	99
4	EBT	130	7	63	27	14	0	73	0	0	0	122
5	WBT	130	10	63	27	11	0	76	0	0	0	104
6	NBL	130	12	63	27	9	0	78	0	0	0	66
7	SBT	105	9	42	27	8	0	54	0	0	0	3
8	EBT	120	10	55	27	9	0	68	0	0	0	106
9	WBT	120	8	57	27	9	0	68	0	0	0	5
10	NBL	130	7	63	27	14	0	73	0	0	0	54
11	SBT	105	9	38	27	12	0	50	0	0	0	94
12	EBT	105	9	38	27	12	0	50	0	0	0	94
13	WBT	105	9	42	27	8	0	54	0	0	0	56
14	NBL	105	9	42	27	8	0	54	0	0	0	56
15	SBT	130	9	67	27	8	0	79	0	0	0	94
16	EBT	130	7	63	27	14	0	73	0	0	0	54
17	WBT	130	12	63	27	9	0	78	0	0	0	47
20	NBL	130	10	63	27	11	0	76	0	0	0	104

Local TOD Schedule

Time	Plan	DOW
0000	8	Su M T W Th S
0000	Free	F
0030	11	Su
0030	Free	M T W Th
0600	8	Su M T W Th F S
0800	7	Su
0800	5	M T W Th F
1000	7	Su
1030	4	S
1515	16	M T W Th F
1615	6	M T W Th F
1830	4	Su M T W Th F
2000	8	Su M T W Th F S
2330	Free	M T W Th

TOD Schedule Report for 3276: Alton Rd&20 St

Current Time of Day Function

<u>Time</u>	<u>Function</u>	<u>Settings *</u>	<u>Day of Week</u>
0000	TOD OUTPUTS	-----	Su M T W Th S
0030	TOD OUTPUTS	-----1	M T W Th
0100	TOD OUTPUTS	-----2-	M T W Th F
0600	TOD OUTPUTS	-----	Su M T W Th F S
2330	TOD OUTPUTS	-----1	M T W Th

Local Time of Day Function

<u>Time</u>	<u>Function</u>	<u>Settings *</u>	<u>Day of Week</u>
0000	TOD OUTPUTS	-----	Su M T W Th S
0000	TOD OUTPUTS	-----1	F
0030	TOD OUTPUTS	-----1	M T W Th
0100	TOD OUTPUTS	-----2-	M T W Th F
0600	TOD OUTPUTS	-----	Su M T W Th F S
2330	TOD OUTPUTS	-----1	M T W Th

*** Settings**

- Blank - FREE - Phase Bank 1, Max 1
- Blank - Plan - Phase Bank 1, Max 2
- 1 - Phase Bank 2, Max 1
- 2 - Phase Bank 2, Max 2
- 3 - Phase Bank 3, Max 1
- 4 - Phase Bank 3, Max 2
- 5 - EXTERNAL PERMIT 1
- 6 - EXTERNAL PERMIT 2
- 7 - X-PED OMIT
- 8 - TBA



Print Time:
2:01 AM

Miami-Dade County Traffic Signals

TOD Schedule Report for 3392: Alton Rd&Michigan A

Print Date:
2/3/2010

Active Phase Bank: Phase Bank

Phase	Walk			Don't Walk			Min Initial			Veh Ext			Max Limit			Max 2			Yellow			Red		
	1	2	3	1	2	3	1	2	3	1	2	3	1	2	3	1	2	3	1	2	3	1	2	3
1 SBL	0	0	0	0	0	0	5	5	5	2	2	2	6	6	6	22	22	22	3	3	3	0	0	0
2 NBT	7	7	7	14	14	14	7	7	7	1	1	1	40	40	40	0	0	0	4	4	4	1	1	1
3	0	0	0	0	0	0	0	0	0	0	0	0	0	0	0	0	0	0	0	0	0	0	0	0
4 EBT	7	7	7	25	25	25	7	7	7	2.5	2.5	2.5	12	12	12	32	32	31	4	4	4	1	1	1
5	0	0	0	0	0	0	0	0	0	0	0	0	0	0	0	0	0	0	0	0	0	0	0	0
6 SBT	7	7	7	14	14	14	7	7	7	1	1	1	40	40	40	0	0	0	4	4	4	1	1	1
7	0	0	0	0	0	0	0	0	0	0	0	0	0	0	0	0	0	0	0	0	0	0	0	0
8 WBT	0	0	0	0	0	0	7	7	7	2.5	2.5	2.5	12	12	12	32	32	31	4	4	4	1	1	1

Last In Service Date:

Permitted Phases	12345678
Default	12-4-6-8
External Permit 0	-----
External Permit 1	-2-4-6-8
External Permit 2	-2-4-6-8

Current TOD Schedule	Plan	Cycle	Green Time								Ring_Offset	Offset
			1	2	3	4	5	6	7	8		
1	160	8	108	0	31	0	119	0	31	0	34	
2	160	8	108	0	31	0	119	0	31	0	19	
3	120	14	62	0	31	0	79	0	31	0	96	
4	130	14	72	0	31	0	89	0	31	0	8	
5	130	14	72	0	31	0	89	0	31	0	124	
6	130	14	72	0	31	0	89	0	31	0	67	
7	105	14	47	0	31	0	64	0	31	0	2	
8	120	13	63	0	31	0	79	0	31	0	115	
9	120	14	62	0	31	0	79	0	31	0	20	
10	130	14	72	0	31	0	89	0	31	0	73	
13	105	8	53	0	31	0	64	0	31	0	60	
14	105	8	53	0	31	0	64	0	31	0	14	
15	130	12	74	0	31	0	89	0	31	0	101	
16	130	14	72	0	31	0	89	0	31	0	73	
17	130	24	62	0	31	0	89	0	31	0	67	
18	90	8	38	0	31	0	49	0	31	0	38	
19	90	8	38	0	31	0	49	0	31	0	42	
20	130	24	62	0	31	0	89	0	31	0	122	
23	90	8	38	0	31	0	49	0	31	0	42	

Local TOD Schedule	Time	Plan	DOW
0000	8	Free	Su M T W Th S
0030	Free	Free	F S
0030	Free	Free	Su
0600	8	Free	M T W Th F S
0800	7	7	Su
0800	5	5	M T W Th F
1000	4	4	W
1030	7	7	S
1515	16	16	M T W Th F
1615	6	6	M T W Th F
1830	4	4	Su M T W Th F S
2000	8	8	Su M T W Th F S
2330	Free	Free	M T W Th

TOD Schedule Report for 3392: Alton Rd&Michigan A

Current Time of Day Function			
<u>Time</u>	<u>Function</u>	<u>Settings *</u>	<u>Day of Week</u>
0000	TOD OUTPUTS	-----	SuM T W ThF S

Local Time of Day Function			
<u>Time</u>	<u>Function</u>	<u>Settings *</u>	<u>Day of Week</u>
0000	TOD OUTPUTS	-----	SuM T W ThF S

* Settings
Blank - FREE - Phase Bank 1, Max 1
Blank - Plan - Phase Bank 1, Max 2
1 - Phase Bank 2, Max 1
2 - Phase Bank 2, Max 2
3 - Phase Bank 3, Max 1
4 - Phase Bank 3, Max 2
5 - EXTERNAL PERMIT 1
6 - EXTERNAL PERMIT 2
7 - X-PED OMIT
8 - TBA

Asset	Interestion	TOD Schedule	Op.Mode	Plan#	Cycle	Offset	TOD Setting	Active PhaseBank	Active Maximum
3391	Dade Blvd&Michigan Av N	DOW-5	N/A	N/A	0	0	N/A	0	Max 0

Splits

PH1	PH2	PH3	PH4	PH5	PH6	PH7	PH8
-	SWT	PED	SET	-	NET	-	-
0	0	0	0	0	0	0	0



N/A



Active Phase Bank: Phase Bank 1

Phase	Walk			Don't Walk			Min Initial			Veh Ext			Max Limit			Max 2			Yellow			Red		
	1	2	3	1	2	3	1	2	3	1	2	3	1	2	3	1	2	3	1	2	3	1	2	3
1 -	0	0	0	0	0	0	0	0	0	0	0	0	0	0	0	0	0	0	0	0	0	0	0	0
2 SWT	0	0	0	0	0	0	14	14	14	1	1	1	25	21	25	0	21	25	4	4	4	0	0	0
3 PED	7	7	7	23	23	23	0	0	0	0	0	0	0	0	0	0	0	0	0	0	0	0	0	0
4 SET	0	0	0	0	0	0	7	7	7	2.5	2.5	2.5	9	9	15	20	20	20	4	4	4	0	0	0
5 -	0	0	0	0	0	0	0	0	0	0	0	0	0	0	0	0	0	0	0	0	0	0	0	0
6 NET	0	0	0	0	0	0	14	14	14	1	1	1	25	21	25	0	21	25	4	4	4	0	0	0
7 -	0	0	0	0	0	0	0	0	0	0	0	0	0	0	0	0	0	0	0	0	0	0	0	0
8 -	0	0	0	0	0	0	0	0	0	0	0	0	0	0	0	0	0	0	0	0	0	0	0	0

Last In Service Date: unknown

Permitted Phases	
Default	12345678
External Permit 0	-2346--
External Permit 1	-----
External Permit 2	-----

Current TON Schedule	Plan	Cycle	Green Time										
			1	2	3	4	5	6	7	8			
2		100	0	48	0	42	0	48	0	48	0	0	0
3		100	0	48	0	42	0	48	0	48	0	0	8
4		100	0	41	0	49	0	41	0	41	0	0	98
5		80	0	28	0	42	0	28	0	28	0	0	57
6		120	0	64	0	46	0	64	0	64	0	0	7
9		90	0	24	0	56	0	24	0	24	0	0	65
10		80	0	23	0	47	0	23	0	23	0	0	12
11		80	0	30	0	40	0	30	0	30	0	0	27
13		85	0	30	0	45	0	30	0	30	0	0	13
14		85	0	26	0	49	0	26	0	26	0	0	27
15		90	0	24	0	56	0	24	0	24	0	0	65
16		80	0	23	0	47	0	23	0	23	0	0	12
17		80	0	30	0	40	0	30	0	30	0	0	27
23		80	0	28	0	42	0	28	0	28	0	0	57

Local TOD Schedule		
Time	Plan	DOW
0000	Free	Su M T W Th F S
0600	13	M T W Th F
0700	2	M T W Th F
0830	13	M T W Th F
1000	13	Su M T W Th F S
1415	14	M T W Th F
1500	4	M T W Th F
1645	4	M T W Th
1830	13	M T W Th F
2000	Free	Su
2200	Free	M T W Th F

Current Time of Day Function			
Time	Function	Settings *	Day of Week
0000	TOD OUTPUTS	-----1	Su M T W Th F S
0100	TOD OUTPUTS	-----	Su M T W Th F S
2200	TOD OUTPUTS	-----1	M T W Th F S

Local Time of Day Function			
Time	Function	Settings *	Day of Week
0000	TOD OUTPUTS	-----1	Su M T W Th F S
0100	TOD OUTPUTS	-----	Su M T W Th F S
0700	TOD OUTPUTS	-----1	Su S
1000	TOD OUTPUTS	-----	Su S
2000	TOD OUTPUTS	-----1	Su
2200	TOD OUTPUTS	-----1	M T W Th F S

* Settings
Blank - FREE - Phase Bank 1, Max 1
Blank - Plan - Phase Bank 1, Max 2
1 - Phase Bank 2, Max 1
2 - Phase Bank 2, Max 2
3 - Phase Bank 3, Max 1
4 - Phase Bank 3, Max 2
5 - EXTERNAL PERMIT 1
6 - EXTERNAL PERMIT 2
7 - X-PED OMIT
8 - TBA

No Calendar Defined/Enabled

CH Perez and Associates Consulting Engineers Inc.

9594 NW 41st Street, Suite 201
Miami, Florida, 33178

Turning Movement Count
SR 907/Alton Road at Dade Boulevard

File Name : SR 907 at Dade Blvd
Site Code : 00190702
Start Date : 3/29/2011
Page No : 1

Groups Printed- Passenger Veh - Heavy Veh

Start Time	SR 907/Alton Road Southbound					Dade Boulevard Westbound					SR 907/Alton Road Northbound					Dade Boulevard Eastbound					Int. Total
	Right	Thru	Left	P&B CNL	App. Total	Right	Thru	Left	P&B CNL	App. Total	Right	Thru	Left	P&B CNL	App. Total	Right	Thru	Left	P&B CWL	App. Total	
08:15 AM	21	242	9	1	273	8	19	66	7	100	35	195	8	3	241	7	27	52	5	91	705
08:30 AM	23	250	16	3	292	11	28	68	3	110	37	227	8	0	272	4	15	34	5	58	732
08:45 AM	21	305	13	3	343	9	42	63	10	124	47	202	9	4	262	9	17	33	8	67	796
Total	65	798	38	7	908	28	89	197	20	334	119	624	25	7	775	20	59	119	18	216	2233
09:00 AM	36	292	11	3	342	14	26	82	5	127	28	212	16	0	256	7	18	40	3	68	793
09:15 AM	23	286	19	6	334	17	33	69	9	128	39	164	15	0	218	8	13	33	8	62	742
09:30 AM	26	226	7	2	261	13	23	54	18	108	27	154	17	0	198	8	54	22	5	89	656
09:45 AM	23	279	10	4	316	9	17	78	11	115	38	148	14	0	200	12	21	21	5	59	690
Total	108	1083	47	15	1253	53	99	283	43	478	132	678	62	0	872	35	106	116	21	278	2881
10:00 AM	14	276	14	4	308	16	25	59	9	109	47	201	15	0	263	7	17	28	3	55	735
*** BREAK ***																					
Total	14	276	14	4	308	16	25	59	9	109	47	201	15	0	263	7	17	28	3	55	735
*** BREAK ***																					
03:30 PM	22	258	17	4	301	29	36	67	12	144	53	286	19	0	358	6	49	35	10	100	903
03:45 PM	23	263	19	4	309	28	38	82	7	155	37	312	14	2	365	9	20	33	12	74	903
Total	45	521	36	8	610	57	74	149	19	299	90	598	33	2	723	15	69	68	22	174	1806
04:00 PM	14	249	17	2	282	16	25	74	15	130	44	308	8	1	361	12	26	25	18	81	854
04:15 PM	15	248	17	2	282	25	39	86	19	169	52	348	30	5	435	8	22	20	12	62	948
04:30 PM	16	234	13	10	273	26	35	75	14	150	60	292	22	6	380	23	20	31	10	84	887
04:45 PM	15	241	24	2	282	21	37	76	16	150	66	289	18	5	378	10	32	29	19	90	900
Total	60	972	71	16	1119	88	136	311	64	599	222	1237	78	17	1554	53	100	105	59	317	3589
05:00 PM	18	251	6	1	276	38	29	57	10	134	56	316	19	3	394	21	23	35	17	96	900
05:15 PM	21	252	18	4	295	21	40	70	22	153	63	290	10	1	364	14	29	27	5	75	887
Grand Total	331	4153	230	55	4769	301	492	1126	187	2106	729	3944	242	30	4945	165	403	498	145	1211	13031
Apprch %	6.9	87.1	4.8	1.2		14.3	23.4	53.5	8.9		14.7	79.8	4.9	0.6		13.6	33.3	41.1	12		
Total %	2.5	31.9	1.8	0.4	36.6	2.3	3.8	8.6	1.4	16.2	5.6	30.3	1.9	0.2	37.9	1.3	3.1	3.8	1.1	9.3	
Passenger Veh	316	4055	225	55	4661	294	475	1117	187	2073	720	3872	226	30	4848	158	394	480	145	1177	12759
% Passenger Veh	95.5	97.9	97.8	100	97.7	97.7	96.5	99.2	100	98.4	98.8	98.2	93.4	100	98	95.8	97.8	96.4	100	97.2	97.9
Heavy Veh	15	88	5	0	108	7	17	9	0	33	9	72	16	0	97	7	9	18	0	34	272
% Heavy Veh	4.5	2.1	2.2	0	2.3	2.3	3.5	0.8	0	1.6	1.2	1.8	6.6	0	2	4.2	2.2	3.6	0	2.8	2.1

P&B CNL: Pedestrians and Bicyclists Crossing North Leg
P&B CEL: Pedestrians and Bicyclists Crossing East Leg
P&B CSL: Pedestrians and Bicyclists Crossing South Leg
P&B CWL: Pedestrians and Bicyclists Crossing West Leg

CH Perez and Associates Consulting Engineers Inc.

9594 NW 41st Street, Suite 201
Miami, Florida, 33178

Turning Movement Count
SR 907/Alton Road at 20th Street

File Name : SR 907 at 20 St
Site Code : 02000701
Start Date : 3/30/2011
Page No : 1

Groups Printed- Passenger Veh - Heavy Veh

Start Time	SR 907/Alton Road Southbound					20th Street Westbound					SR 907/Alton Road Northbound					20th Street Eastbound					Int. Total
	Right	Thru	Left	P&B CNL	App. Total	Right	Thru	Left	P&B CWL	App. Total	Right	Thru	Left	P&B CSL	App. Total	Right	Thru	Left	P&B CWL	App. Total	
08:15 AM	28	257	7	0	292	0	0	0	0	0	1	207	25	0	233	1	1	26	1	29	554
08:30 AM	40	277	6	0	323	6	2	1	2	11	6	237	19	0	262	1	3	22	3	29	625
08:45 AM	76	291	7	0	374	1	0	0	1	2	3	213	22	0	238	1	2	30	0	33	647
Total	144	825	20	0	989	7	2	1	3	13	10	657	66	0	733	3	6	78	4	91	1826
09:00 AM	55	315	2	0	372	2	0	1	2	5	1	203	24	0	228	1	3	32	0	36	641
09:15 AM	53	271	3	1	328	0	0	2	1	3	5	179	24	2	210	3	1	33	1	38	579
09:30 AM	52	278	9	0	339	1	0	0	7	8	6	182	23	0	211	3	2	28	0	33	591
09:45 AM	43	263	9	2	317	3	1	2	4	10	5	183	22	2	212	0	1	28	0	29	568
Total	203	1127	23	3	1356	6	1	5	14	26	17	747	93	4	861	7	7	121	1	136	2379
10:00 AM	44	264	7	0	315	7	0	3	0	10	3	184	35	1	223	5	3	24	1	33	581
*** BREAK ***																					
Total	44	264	7	0	315	7	0	3	0	10	3	184	35	1	223	5	3	24	1	33	581
*** BREAK ***																					
03:30 PM	52	246	13	0	311	7	0	1	1	9	9	326	33	0	368	0	2	50	0	52	740
03:45 PM	46	243	4	0	293	4	0	2	2	8	8	315	38	0	361	2	4	45	2	53	715
Total	98	489	17	0	604	11	0	3	3	17	17	641	71	0	729	2	6	95	2	105	1455
04:00 PM	55	237	3	0	295	4	0	1	0	5	5	318	22	0	345	2	1	48	0	51	696
04:15 PM	54	223	7	0	284	3	1	1	1	6	4	307	14	0	325	1	1	41	0	43	658
04:30 PM	49	233	7	0	289	4	0	1	0	5	2	330	28	0	360	3	2	40	0	45	699
04:45 PM	55	239	1	0	295	6	0	0	0	6	2	293	25	0	320	3	2	33	0	38	659
Total	213	932	18	0	1163	17	1	3	1	22	13	1248	89	0	1350	9	6	162	0	177	2712
05:00 PM	52	233	12	0	297	1	0	1	0	2	4	312	15	0	331	1	3	42	0	46	676
05:15 PM	53	256	2	0	311	3	0	2	0	5	4	316	36	0	356	2	4	45	0	51	723
Grand Total	807	4126	99	3	5035	52	4	18	21	95	68	4105	405	5	4583	29	35	567	8	639	10352
Apprch %	16	81.9	2	0.1		54.7	4.2	18.9	22.1		1.5	89.6	8.8	0.1		4.5	5.5	88.7	1.3		
Total %	7.8	39.9	1	0	48.6	0.5	0	0.2	0.2	0.9	0.7	39.7	3.9	0	44.3	0.3	0.3	5.5	0.1	6.2	
Passenger Veh	792	4047	95	3	4937	52	4	18	21	95	68	4038	391	5	4502	18	34	557	8	617	10151
% Passenger Veh	98.1	98.1	96	100	98.1	100	100	100	100	100	100	98.4	96.5	100	98.2	62.1	97.1	98.2	100	96.6	98.1
Heavy Veh	15	79	4	0	98	0	0	0	0	0	0	67	14	0	81	11	1	10	0	22	201
% Heavy Veh	1.9	1.9	4	0	1.9	0	0	0	0	0	0	1.6	3.5	0	1.8	37.9	2.9	1.8	0	3.4	1.9

P&B CNL: Pedestrians and Bicyclists Crossing North Leg
P&B CEL: Pedestrians and Bicyclists Crossing East Leg
P&B CSL: Pedestrians and Bicyclists Crossing South Leg
P&B CWL: Pedestrians and Bicyclists Crossing West Leg

CH Perez and Associates Consulting Engineers Inc.

9594 NW 41st Street, Suite 201
Miami, Florida, 33178

Turning Movement Count
SR 907/Alton Road at 19th Street

File Name : sr 907 at 19 st
Site Code : 00190331
Start Date : 3/31/2011
Page No : 1

Groups Printed- Passenger Veh - Heavy Veh

Start Time	SR 907/Alton Road Southbound					19th Street Westbound					SR 907/Alton Road Northbound					19th Street Eastbound					Int. Total
	Right	Thru	Left	P&B CNL	App. Total	Right	Thru	Left	P&B CEL	App. Total	Right	Thru	Left	P&B CSL	App. Total	Right	Thru	Left	P&B CWL	App. Total	
08:15 AM	12	285	0	0	297	8	0	0	0	8	9	230	0	0	239	17	0	0	0	17	561
08:30 AM	10	285	2	0	298	13	0	0	0	13	14	245	0	0	260	8	0	0	0	8	579
08:45 AM	0	315	0	0	315	15	0	0	0	15	13	223	0	0	236	28	0	0	0	28	595
Total	22	885	2	0	910	37	0	0	0	37	36	699	0	0	735	53	0	0	0	53	1735
09:00 AM	2	272	0	0	274	10	0	0	0	10	20	214	0	0	234	23	0	0	0	23	541
09:15 AM	0	327	0	0	327	7	0	0	0	7	13	208	0	0	221	28	2	0	0	30	585
09:30 AM	14	284	0	0	298	7	0	0	0	7	22	208	0	0	230	15	3	0	0	19	554
09:45 AM	8	280	0	0	288	6	0	0	0	6	17	187	0	0	204	19	0	0	0	19	517
Total	24	1163	0	0	1187	30	0	0	0	30	72	817	0	0	889	85	5	0	0	91	2197
10:00 AM	2	301	0	0	303	12	0	0	0	12	11	194	0	0	205	25	0	0	0	25	546
*** BREAK ***																					
Total	2	301	0	0	303	12	0	0	0	12	11	194	0	0	205	25	0	0	0	25	546
*** BREAK ***																					
03:30 PM	1	271	0	0	272	21	0	0	1	22	32	345	0	0	377	24	0	0	4	28	699
03:45 PM	0	242	0	0	242	15	0	0	0	15	32	333	0	0	365	29	0	0	1	30	653
Total	1	513	0	0	514	37	0	0	1	38	64	678	0	0	742	53	0	0	5	58	1352
04:00 PM	1	238	0	3	242	17	0	0	3	20	28	356	0	3	387	32	0	0	3	35	684
04:15 PM	3	225	0	0	228	10	0	0	0	10	30	350	0	0	380	29	0	0	0	29	647
04:30 PM	0	272	0	1	273	20	0	0	1	21	28	332	0	1	361	15	0	0	0	16	671
04:45 PM	0	236	0	1	237	24	0	0	2	26	29	295	0	3	327	20	0	0	1	21	611
Total	4	971	0	5	980	71	0	0	6	77	115	1333	0	7	1455	97	0	0	4	101	2513
05:00 PM	0	229	0	0	229	19	0	0	4	23	13	370	0	1	384	25	0	0	3	29	655
05:15 PM	0	247	0	1	248	19	0	0	0	19	23	311	0	2	336	23	0	0	0	23	626
Grand Total	53	4310	2	6	4371	225	0	0	11	236	334	4402	0	10	4746	364	5	0	12	381	9734
Apprch %	1.2	98.6	0	0.1		95.3	0	0	4.7		7	92.8	0	0.2		95.5	1.3	0	3.1		
Total %	0.5	44.3	0	0.1	44.9	2.3	0	0	0.1	2.4	3.4	45.2	0	0.1	48.8	3.7	0.1	0	0.1	3.9	
Passenger Veh	53	4214	2	6	4275	221	0	0	11	232	331	4336	0	10	4677	357	3	0	12	372	9556
% Passenger Veh	100	97.8	100	100	97.8	98.2	0	0	100	98.3	99.1	98.5	0	100	98.5	98.1	60	0	100	97.6	98.2
Heavy Veh	0	96	0	0	96	4	0	0	0	4	3	66	0	0	69	7	2	0	0	9	178
% Heavy Veh	0	2.2	0	0	2.2	1.8	0	0	0	1.7	0.9	1.5	0	0	1.5	1.9	40	0	0	2.4	1.8

P&B CNL: Pedestrians and Bicyclists Crossing North Leg
P&B CEL: Pedestrians and Bicyclists Crossing East Leg
P&B CSL: Pedestrians and Bicyclists Crossing South Leg
P&B CWL: Pedestrians and Bicyclists Crossing West Leg

CH Perez and Associates Consulting Engineers Inc.

9594 NW 41st Street, Suite 201
Miami, Florida, 33178

Turning Movement Count
SR 907/Alton Road at Michigan Avenue

File Name : SR 907 at Michigan Ave
Site Code : 00290701
Start Date : 3/30/2011
Page No : 1

Groups Printed- Passenger Veh - Heavy Veh

Start Time	SR 907/Alton Road Southbound					Michigan Avenue Westbound					SR 907/Alton Road Northbound					Michigan Avenue Eastbound					Int. Total
	Right	Thru	Left	P&B CNL	App. Total	Right	Thru	Left	P&B CWL	App. Total	Right	Thru	Left	P&B CSL	App. Total	Right	Thru	Left	P&B CWL	App. Total	
08:15 AM	13	282	122	0	417	71	1	3	1	76	2	242	1	1	246	0	1	0	0	1	740
08:30 AM	4	334	131	0	469	74	2	1	2	79	3	250	1	2	256	0	1	1	5	7	811
08:45 AM	5	385	145	1	538	82	3	2	0	87	9	239	1	0	249	0	0	1	0	1	875
Total	22	1002	399	1	1424	227	6	6	3	242	14	731	3	3	751	0	2	2	5	9	2426
09:00 AM	1	379	145	0	526	56	0	3	0	59	1	244	0	0	245	0	0	0	1	1	831
09:15 AM	2	335	111	0	448	74	1	0	1	76	5	196	0	0	201	1	1	0	2	4	729
09:30 AM	4	317	110	1	432	56	0	3	0	59	4	198	1	1	204	0	0	0	0	0	695
09:45 AM	3	305	118	0	427	59	0	0	0	59	3	210	0	0	213	3	0	2	2	7	706
Total	10	1337	485	1	1833	245	1	6	1	253	13	848	1	1	863	4	1	2	5	12	2951
10:00 AM	3	304	107	1	415	53	0	3	0	56	8	217	0	2	227	2	0	0	3	5	703
*** BREAK ***																					
Total	3	304	107	1	415	53	0	3	0	56	8	217	0	2	227	2	0	0	3	5	703
*** BREAK ***																					
03:30 PM	1	311	103	0	415	131	0	3	0	134	10	363	0	1	374	2	2	2	1	7	930
03:45 PM	1	294	134	1	430	115	0	5	1	121	14	357	0	1	372	1	0	1	3	5	928
Total	2	605	237	1	845	246	0	8	1	255	24	720	0	2	746	3	2	3	4	12	1858
04:00 PM	2	302	90	0	394	193	2	2	0	197	13	349	0	0	362	0	1	2	2	5	958
04:15 PM	3	293	104	0	400	152	1	2	0	155	16	356	0	0	372	1	1	1	3	6	933
04:30 PM	1	314	96	0	411	168	1	3	2	174	11	349	1	0	361	0	2	0	4	6	952
04:45 PM	2	295	99	0	396	147	0	7	0	154	16	341	0	1	358	0	1	0	2	3	911
Total	8	1204	389	0	1601	660	4	14	2	680	56	1395	1	1	1453	1	5	3	11	20	3754
05:00 PM	3	333	117	0	453	189	0	2	1	192	10	392	0	1	403	0	0	1	2	3	1051
05:15 PM	2	295	92	0	389	167	3	4	1	175	17	345	3	2	367	1	1	1	3	6	937
Grand Total	50	5080	1826	4	6960	1787	14	43	9	1853	142	4548	8	12	4810	11	11	12	33	67	13690
Apprch %	0.7	73	26.2	0.1		95.4	0.8	2.3	0.5		3	96.6	0.2	0.2		16.4	16.4	17.9	49.3		
Total %	0.4	37.1	13.3	0	50.8	13.1	0.1	0.3	0.1	13.5	1	34	0.1	0.1	35.1	0.1	0.1	0.1	0.2	0.5	
Passenger Veh	49	4999	1804	4	6856	1764	14	43	9	1830	142	4578	8	12	4740	10	10	12	33	65	13491
% Passenger Veh	98	98.4	98.8	100	98.5	98.7	100	100	100	98.8	100	98.5	100	100	98.5	90.9	90.9	100	100	97	98.5
Heavy Veh	1	81	22	0	104	23	0	0	0	23	0	70	0	0	70	1	1	0	0	2	199
% Heavy Veh	2	1.6	1.2	0	1.5	1.3	0	0	0	1.2	0	1.5	0	0	1.5	9.1	9.1	0	0	3	1.5

P&B CNL: Pedestrians and Bicyclists Crossing North Leg
P&B CEL: Pedestrians and Bicyclists Crossing East Leg
P&B CSL: Pedestrians and Bicyclists Crossing South Leg
P&B CWL: Pedestrians and Bicyclists Crossing West Leg

LOCATION: Michigan Ave -- Dade Blvd
CITY/STATE: Miami Beach, FL

QC JOB #: 10703207
DATE: Fri, Jan 27 2012

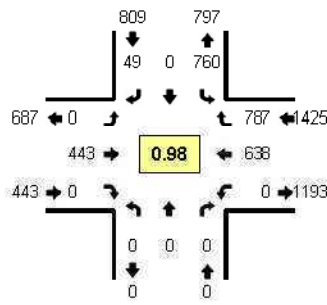

Peak-Hour: 5:15 PM -- 6:15 PM
Peak 15-Min: 5:15 PM -- 5:30 PM

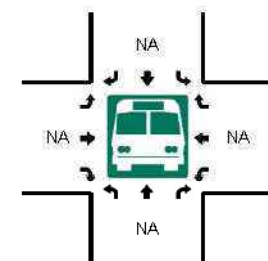
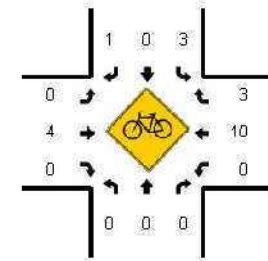
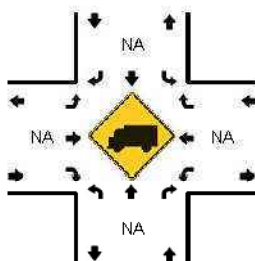
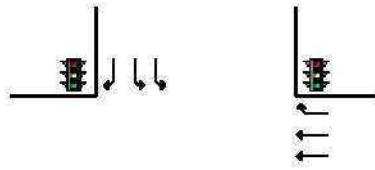
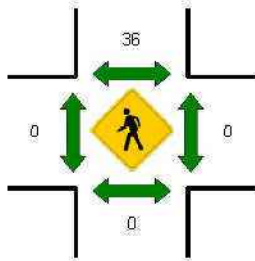
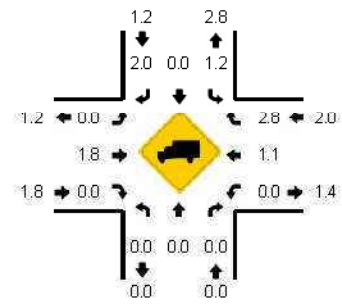

15-Min Count Period Beginning At	Michigan Ave (Northbound)				Michigan Ave (Southbound)				Dade Blvd (Eastbound)				Dade Blvd (Westbound)				Total	Hourly Totals
	Left	Thru	Right	U	Left	Thru	Right	U	Left	Thru	Right	U	Left	Thru	Right	U		
4:00 PM	0	0	0	0	185	0	21	0	0	108	0	0	0	170	188	0	672	
4:15 PM	0	0	0	0	176	0	33	4	0	88	0	0	0	169	200	0	670	
4:30 PM	0	0	0	0	171	0	15	1	0	111	0	0	0	164	198	0	660	
4:45 PM	0	0	0	0	168	0	18	2	0	111	0	0	0	157	183	0	639	2641
5:00 PM	0	0	0	0	180	0	8	3	0	100	0	0	0	146	194	0	631	2600
5:15 PM	0	0	0	0	204	0	14	2	0	105	0	0	0	165	194	0	684	2614
5:30 PM	0	0	0	0	184	0	8	3	0	104	0	0	0	164	206	0	669	2623
5:45 PM	0	0	0	0	156	0	13	1	0	124	0	0	0	155	203	0	652	2636
6:00 PM	0	0	0	0	206	0	14	4	0	110	0	0	0	154	184	0	672	2677
6:15 PM	0	0	0	0	167	0	11	3	0	119	0	0	0	130	165	0	595	2588
6:30 PM	0	0	0	0	209	0	23	3	0	143	0	0	0	137	163	0	678	2597
6:45 PM	0	0	0	0	215	0	15	1	0	109	0	0	0	140	121	0	601	2546
7:00 PM	0	0	0	0	138	0	27	4	0	95	0	0	0	157	137	0	558	2432
7:15 PM	0	0	0	0	158	0	23	1	0	87	0	0	0	135	141	0	545	2382
7:30 PM	0	0	0	0	160	0	22	3	0	83	0	0	0	129	133	0	530	2234
7:45 PM	0	0	0	0	124	0	12	2	0	75	0	0	0	118	94	0	425	2058
Peak 15-Min Flowrates	Northbound				Southbound				Eastbound				Westbound				Total	
All Vehicles	0	0	0	0	816	0	56	8	0	420	0	0	0	660	776	0	2736	
Heavy Trucks	0	0	0	0	4	0	0	0	0	8	0	0	0	8	16	0	36	
Pedestrians						24				0				0			24	
Bicycles	0	0	0	0	1	0	0	0	0	0	0	0	0	2	0	0	3	
Railroad																		
Stopped Buses																		

Comments:

APPENDIX C

Historical Traffic Counts and Peak Season Conversion Factors

2013 PEAK SEASON FACTOR CATEGORY REPORT - REPORT TYPE: ALL
 CATEGORY: 8700 MIAMI-DADE NORTH

WEEK	DATES	SF	MOCF: 0.97 PSCF
1	01/01/2013 - 01/05/2013	1.03	1.06
2	01/06/2013 - 01/12/2013	1.03	1.06
3	01/13/2013 - 01/19/2013	1.03	1.06
4	01/20/2013 - 01/26/2013	1.01	1.04
5	01/27/2013 - 02/02/2013	1.00	1.03
6	02/03/2013 - 02/09/2013	0.99	1.02
* 7	02/10/2013 - 02/16/2013	0.97	1.00
* 8	02/17/2013 - 02/23/2013	0.96	0.99
* 9	02/24/2013 - 03/02/2013	0.96	0.99
*10	03/03/2013 - 03/09/2013	0.96	0.99
*11	03/10/2013 - 03/16/2013	0.96	0.99
*12	03/17/2013 - 03/23/2013	0.97	1.00
*13	03/24/2013 - 03/30/2013	0.97	1.00
*14	03/31/2013 - 04/06/2013	0.97	1.00
*15	04/07/2013 - 04/13/2013	0.98	1.01
*16	04/14/2013 - 04/20/2013	0.98	1.01
*17	04/21/2013 - 04/27/2013	0.98	1.01
*18	04/28/2013 - 05/04/2013	0.99	1.02
*19	05/05/2013 - 05/11/2013	0.99	1.02
20	05/12/2013 - 05/18/2013	1.00	1.03
21	05/19/2013 - 05/25/2013	1.00	1.03
22	05/26/2013 - 06/01/2013	1.00	1.03
23	06/02/2013 - 06/08/2013	1.01	1.04
24	06/09/2013 - 06/15/2013	1.01	1.04
25	06/16/2013 - 06/22/2013	1.02	1.05
26	06/23/2013 - 06/29/2013	1.02	1.05
27	06/30/2013 - 07/06/2013	1.03	1.06
28	07/07/2013 - 07/13/2013	1.04	1.07
29	07/14/2013 - 07/20/2013	1.05	1.08
30	07/21/2013 - 07/27/2013	1.04	1.07
31	07/28/2013 - 08/03/2013	1.03	1.06
32	08/04/2013 - 08/10/2013	1.03	1.06
33	08/11/2013 - 08/17/2013	1.02	1.05
34	08/18/2013 - 08/24/2013	1.02	1.05
35	08/25/2013 - 08/31/2013	1.02	1.05
36	09/01/2013 - 09/07/2013	1.02	1.05
37	09/08/2013 - 09/14/2013	1.02	1.05
38	09/15/2013 - 09/21/2013	1.02	1.05
39	09/22/2013 - 09/28/2013	1.02	1.05
40	09/29/2013 - 10/05/2013	1.01	1.04
41	10/06/2013 - 10/12/2013	1.01	1.04
42	10/13/2013 - 10/19/2013	1.01	1.04
43	10/20/2013 - 10/26/2013	1.01	1.04
44	10/27/2013 - 11/02/2013	1.01	1.04
45	11/03/2013 - 11/09/2013	1.01	1.04
46	11/10/2013 - 11/16/2013	1.01	1.04
47	11/17/2013 - 11/23/2013	1.02	1.05
48	11/24/2013 - 11/30/2013	1.02	1.05
49	12/01/2013 - 12/07/2013	1.02	1.05
50	12/08/2013 - 12/14/2013	1.02	1.05
51	12/15/2013 - 12/21/2013	1.03	1.06
52	12/22/2013 - 12/28/2013	1.03	1.06
53	12/29/2013 - 12/31/2013	1.03	1.06

* PEAK SEASON

18-FEB-2014 08:46:31

830UPD

6_8700_PKSEASON.TXT

Traffic Trends - V2.0

SR 907/ALTON RD -- 200' N OF 20 ST

PIN#	0
Location	1

County: Miami-Dade (87)
 Station #: 0012
 Highway: SR 907/ALTON RD

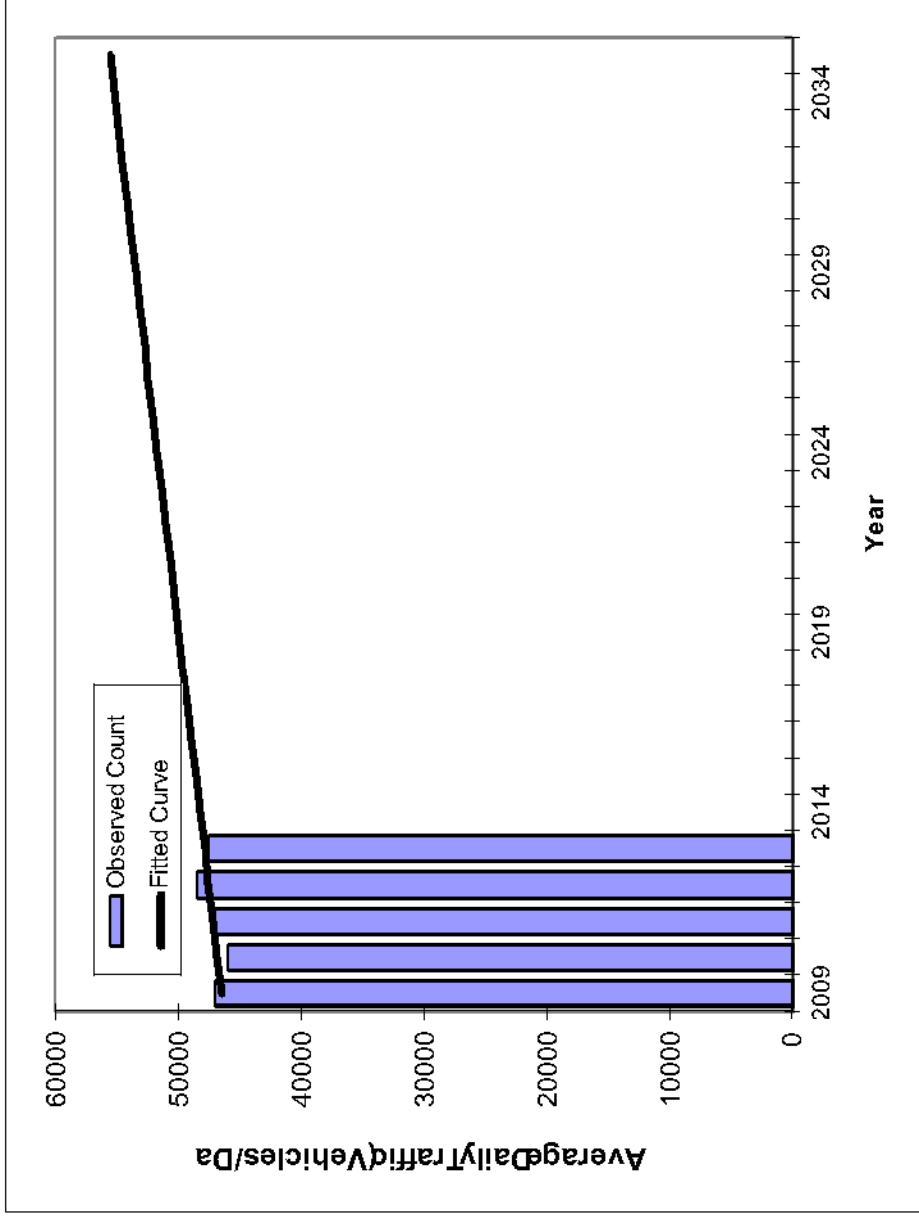

Year	Traffic (ADT/AADT)	
	Count*	Trend**
2009	47000	46500
2010	46000	46900
2011	47000	47200
2012	48500	47600
2013	47500	47900

2014 Opening Year Trend	
2014	N/A 48300
2015 Mid-Year Trend	
2015	N/A 48600
2016 Design Year Trend	
2016	N/A 49000
TRANPLAN Forecasts/Trends	

** Annual Trend Increase: 350
 Trend R-squared: 37.12%
 Trend Annual Historic Growth Rate: 0.75%
 Trend Growth Rate (2013 to Design Year): 0.77%
 Printed: 14-Aug-14

Traffic Trends - V2.0

SR 907/ALTON RD -- 200' S OF VENETIAN CSWY

PIN#	0
Location	1

County:	Miami-Dade (87)
Station #:	2542
Highway:	SR 907/ALTON RD

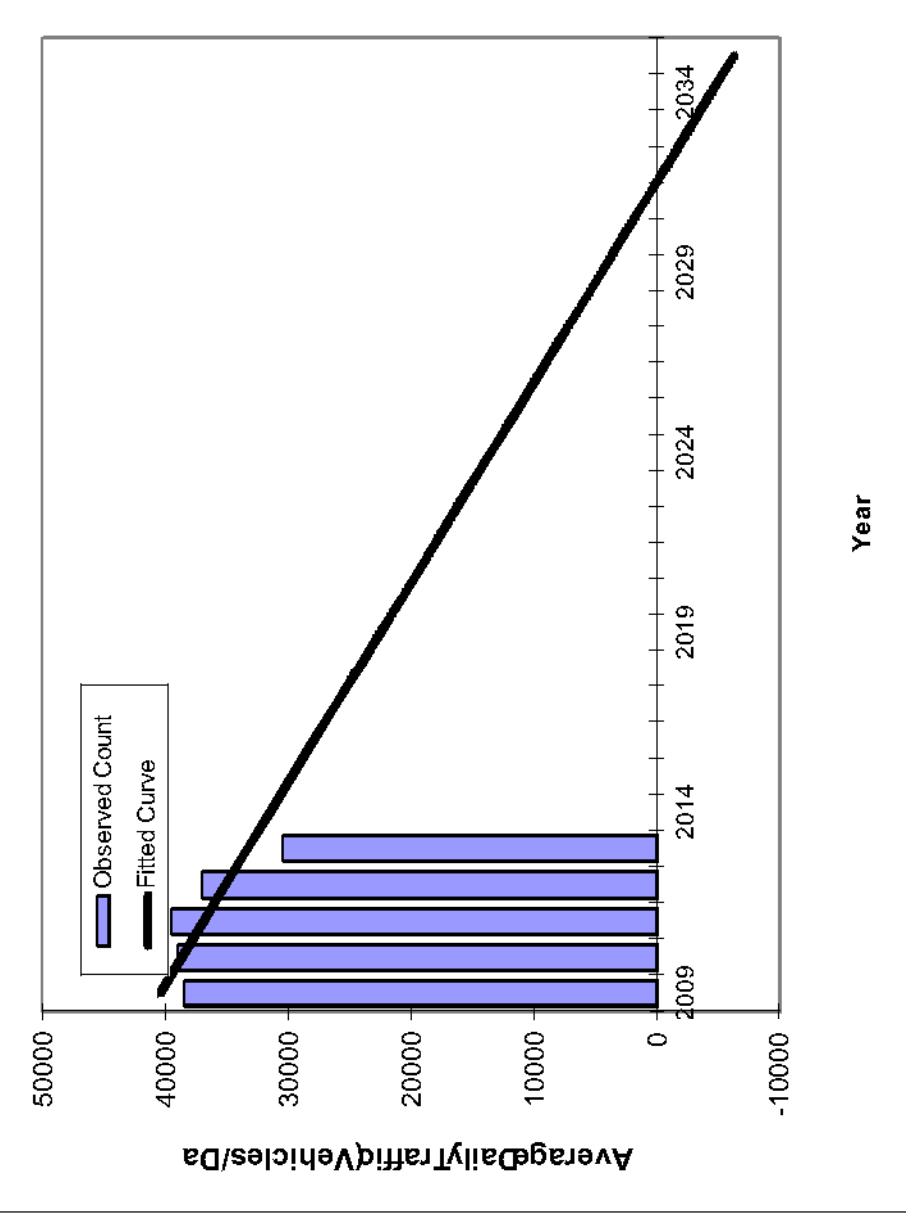

Year	Traffic (ADT/AADT)	
	Count*	Trend**
2009	38500	40500
2010	39000	38700
2011	39500	36900
2012	37000	35100
2013	30500	33300

2014 Opening Year Trend	
2014	N/A 31500
2015 Mid-Year Trend	
2015	N/A 29700
2016 Design Year Trend	
2016	N/A 27900
TRANPLAN Forecasts/Trends	

** Annual Trend Increase:	-1,800
Trend R-squared:	59.23%
Trend Annual Historic Growth Rate:	-4.44%
Trend Growth Rate (2013 to Design Year):	-5.41%
Printed:	14-Aug-14

Traffic Trends - V2.0

VENETIAN CSWY(CR956) -- 200' E OF WEST AVE

PIN#	0
Location	1

County: Miami-Dade (87)
 Station #: 8350
 Highway: VENETIAN CSWY(CR956)

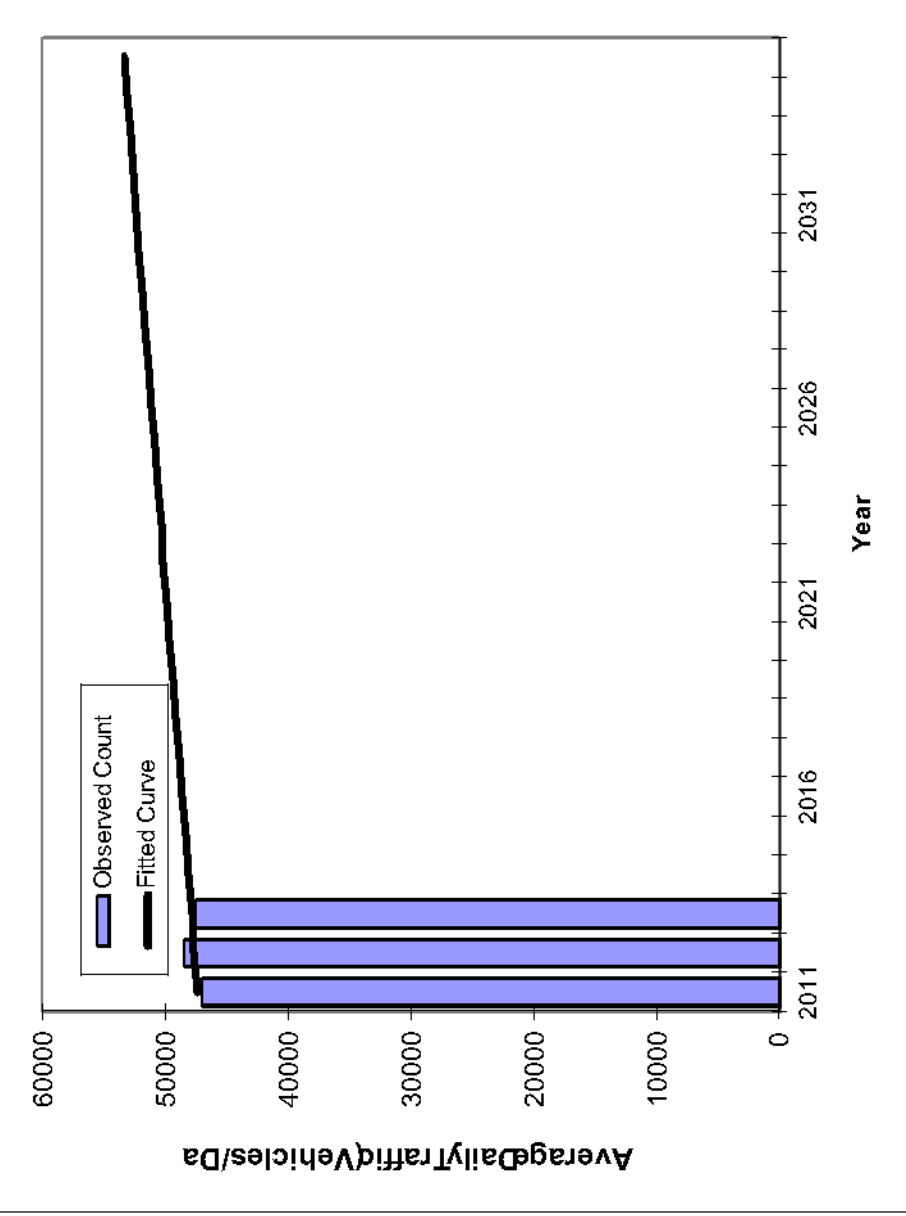

Year	Traffic (ADT/AADT)	
	Count*	Trend**
2011	47000	47400
2012	48500	47700
2013	47500	47900

2014 Opening Year Trend	
2014	N/A 48200
2015 Mid-Year Trend	
2015	N/A 48400
2016 Design Year Trend	
2016	N/A 48700

TRANPLAN Forecasts/Trends

** Annual Trend Increase: 250
 Trend R-squared: 10.71%
 Trend Annual Historic Growth Rate: 0.53%
 Trend Growth Rate (2013 to Design Year): 0.56%
 Printed: 14-Aug-14

APPENDIX D

Projected Turning Movement Volumes

FUTURE TURNING MOVEMENT VOLUME ANALYSIS

**Alton Road and Michigan Avenue
PM Peak Hour (3:30 PM - 4:30 PM)**

Description	Alton Road Northbound			Alton Road Southbound			Michigan Avenue Eastbound			Michigan Avenue Westbound		
	Left	Through	Right	Left	Through	Right	Left	Through	Right	Left	Through	Right
Existing Traffic (3/30/2011)	0	1,425	53	431	1,200	7	6	4	4	12	3	591
Season Adjustment Factor	1.00	1.00	1.00	1.00	1.00	1.00	1.00	1.00	1.00	1.00	1.00	1.00
Annual Growth Rate	1.0%	1.0%	1.0%	1.0%	1.0%	1.0%	1.0%	1.0%	1.0%	1.0%	1.0%	1.0%
2014 Peak Season Traffic	0	1,468	55	444	1,236	7	6	4	4	12	3	609
Annual Growth Rate	1.0%	1.0%	1.0%	1.0%	1.0%	1.0%	1.0%	1.0%	1.0%	1.0%	1.0%	1.0%
2016 Background Traffic	0	1,498	56	453	1,261	7	6	4	4	13	3	621
1901 Alton	14	56	15	58				15				
2016 Total Traffic	14	1,554	71	511	1,261	7	6	19	4	13	3	621

FUTURE TURNING MOVEMENT VOLUME ANALYSIS

**Alton Road and 19th Street
PM Peak Hour (3:30 PM - 4:30 PM)**

Description	Alton Road Northbound			Alton Road Southbound			19th Street Eastbound			19th Street Westbound		
	Left	Through	Right	Left	Through	Right	Left	Through	Right	Left	Through	Right
Existing Traffic (3/31/2011)		1,384	122		977							64
Season Adjustment Factor	1.00	1.00	1.00	1.00	1.00	1.00	1.00	1.00	1.00	1.00	1.00	1.00
Annual Growth Rate	1.0%	1.0%	1.0%	1.0%	1.0%	1.0%	1.0%	1.0%	1.0%	1.0%	1.0%	1.0%
2014 Peak Season Traffic	0	1,426	126	0	1,007	0	0	0	0	0	0	66
Annual Growth Rate	1.0%	1.0%	1.0%	1.0%	1.0%	1.0%	1.0%	1.0%	1.0%	1.0%	1.0%	1.0%
2016 Background Traffic	0	1,455	128	0	1,027	0	0	0	0	0	0	67
1901 Alton			203									84
2016 Total Traffic	0	1,455	331	0	1,027	0	0	0	0	0	0	151

FUTURE TURNING MOVEMENT VOLUME ANALYSIS

**Alton Road and Dade Avenue
PM Peak Hour (3:30 PM - 4:30 PM)**

Description	Alton Road Northbound			Alton Road Southbound			Dade Avenue Eastbound			Dade Avenue Westbound		
	Left	Through	Right	Left	Through	Right	Left	Through	Right	Left	Through	Right
Existing Traffic (3/29/2011)	71	1,254	186	70	1,018	74	113	117	35	309	138	98
Season Adjustment Factor	1.00	1.00	1.00	1.00	1.00	1.00	1.00	1.00	1.00	1.00	1.00	1.00
Annual Growth Rate	1.0%	1.0%	1.0%	1.0%	1.0%	1.0%	1.0%	1.0%	1.0%	1.0%	1.0%	1.0%
2014 Peak Season Traffic	73	1,292	192	72	1,049	76	116	121	36	318	142	101
Annual Growth Rate	1.0%	1.0%	1.0%	1.0%	1.0%	1.0%	1.0%	1.0%	1.0%	1.0%	1.0%	1.0%
2016 Background Traffic	75	1,318	195	74	1,070	78	119	123	37	325	145	103
1901 Alton		87					58			84	56	58
2016 Total Traffic	75	1,405	195	74	1,070	78	177	123	37	409	201	161

FUTURE TURNING MOVEMENT VOLUME ANALYSIS

**19th Street and Michigan Avenue
PM Peak Hour (3:30 PM - 4:30 PM)**

Description	Michigan Avenue Northbound			Michigan Avenue Southbound				19th Street Eastbound			Dade Avenue Northwestbound			Dade Avenue Southwestbound		
	Left	Through	Right	Left	Through	Hard Right	Right	Left	Through	Right	Left	Through	Right	Left	Through	Right
Existing Traffic (1/27/2012)		776			722	102	108			66		392			678	776
Season Adjustment Factor	1.03	1.03	1.03	1.03	1.03	1.03	1.03	1.03	1.03	1.03	1.03	1.03	1.03	1.03	1.03	1.03
Annual Growth Rate	1.0%	1.0%	1.0%	1.0%	1.0%	1.0%	1.0%	1.0%	1.0%	1.0%	1.0%	1.0%	1.0%	1.0%	1.0%	1.0%
2014 Peak Season Traffic	0	815	0	0	759	107	113	0	0	69	0	412	0	0	712	815
Annual Growth Rate	1.0%	1.0%	1.0%	1.0%	1.0%	1.0%	1.0%	1.0%	1.0%	1.0%	1.0%	1.0%	1.0%	1.0%	1.0%	1.0%
2016 Background Traffic	0	832	0	0	774	109	116	0	0	71	0	420	0	0	727	832
1901 Alton				56		88	140			196					58	
2016 Total Traffic	0	832	0	56	774	197	256	0	0	267	0	420	0	0	785	832

FUTURE TURNING MOVEMENT VOLUME ANALYSIS























**19th Street and Project Driveway
PM Peak Hour (3:30 PM - 4:30 PM)**

Description	Northbound			Driveway Southbound			19th Street Eastbound			19th Street Westbound		
	Left	Through	Right	Left	Through	Right	Left	Through	Right	Left	Through	Right
Existing Traffic (3/31/2011)								30				104
Season Adjustment Factor	1.00	1.00	1.00	1.00	1.00	1.00	1.00	1.00	1.00	1.00	1.00	1.00
Annual Growth Rate	1.0%	1.0%	1.0%	1.0%	1.0%	1.0%	1.0%	1.0%	1.0%	1.0%	1.0%	1.0%
2014 Peak Season Traffic	0	0	0	0	0	0	0	31	0	0	107	0
Annual Growth Rate	1.0%	1.0%	1.0%	1.0%	1.0%	1.0%	1.0%	1.0%	1.0%	1.0%	1.0%	1.0%
2016 Background Traffic	0	0	0	0	0	0	0	32	0	0	109	0
1901 Alton				196		84	203					88
2016 Total Traffic	0	0	0	196	0	84	203	32	0	0	109	88

APPENDIX E
Intersection Capacity Analyses

Lanes, Volumes, Timings
2: Alton Rd & Dade Blvd

3/31/2015

												
Lane Group	EBL	EBT	EBR	WBL	WBT	WBR	NBL	NBT	NBR	SBL	SBT	SBR
Lane Configurations												
Volume (vph)	116	121	36	318	142	101	73	1292	192	72	1049	76
Ideal Flow (vphpl)	1900	1900	1900	1900	1900	1900	1900	1900	1900	1900	1900	1900
Lane Width (ft)	11	12	12	11	12	12	11	12	12	11	12	12
Storage Length (ft)	220		0	185		60	0		0	0		70
Storage Lanes	1		0	1		1	1		0	1		1
Taper Length (ft)	25			25			25			25		
Lane Util. Factor	1.00	0.95	0.95	1.00	0.95	1.00	1.00	0.95	0.95	1.00	0.95	1.00
Ped Bike Factor		0.99				0.93		1.00				0.96
Fr't		0.966				0.850		0.981				0.850
Flt Protected	0.950			0.950			0.950			0.950		
Satd. Flow (prot)	1525	3003	0	*1525	3185	1425	1540	*3185	0	1540	3185	1425
Flt Permitted	0.640			0.563			0.162			0.950		
Satd. Flow (perm)	1027	3003	0	*992	3185	1331	263	*3185	0	1540	3185	1370
Right Turn on Red			Yes			Yes			Yes			Yes
Satd. Flow (RTOR)		31				115		15				45
Link Speed (mph)		30			30			35			35	
Link Distance (ft)		737			978			249			313	
Travel Time (s)		16.8			22.2			4.9			6.1	
Confl. Peds. (#/hr)			52			55			14			18
Peak Hour Factor	0.80	0.80	0.80	0.88	0.88	0.88	0.87	0.87	0.87	0.95	0.95	0.95
Heavy Vehicles (%)	3%	3%	3%	2%	2%	2%	2%	2%	2%	2%	2%	2%
Adj. Flow (vph)	145	151	45	361	161	115	84	1485	221	76	1104	80
Shared Lane Traffic (%)												
Lane Group Flow (vph)	145	196	0	361	161	115	84	1706	0	76	1104	80
Enter Blocked Intersection	No	No	No	No	No	No	No	No	No	No	No	No
Lane Alignment	Left	Left	Right	Left	Left	Right	Left	Left	Right	Left	Left	Right
Median Width(ft)		11			11			11			11	
Link Offset(ft)		0			0			0			0	
Crosswalk Width(ft)		16			16			16			16	
Two way Left Turn Lane												
Headway Factor	1.19	1.14	1.14	1.19	1.14	1.14	1.19	1.14	1.14	1.19	1.14	1.14
Turning Speed (mph)	15		9	15		9	15		9	15		9
Number of Detectors	1	1		1	1	1	1	1		1	1	1
Detector Template												
Leading Detector (ft)	50	50		50	50	50	50	50		50	50	50
Trailing Detector (ft)	0	0		0	0	0	0	0		0	0	0
Detector 1 Position(ft)	0	0		0	0	0	0	0		0	0	0
Detector 1 Size(ft)	50	50		50	50	50	50	50		50	50	50
Detector 1 Type	Cl+Ex	Cl+Ex		Cl+Ex	Cl+Ex	Cl+Ex	Cl+Ex	Cl+Ex		Cl+Ex	Cl+Ex	Cl+Ex
Detector 1 Channel												
Detector 1 Extend (s)	0.0	0.0		0.0	0.0	0.0	0.0	0.0		0.0	0.0	0.0
Detector 1 Queue (s)	0.0	0.0		0.0	0.0	0.0	0.0	0.0		0.0	0.0	0.0
Detector 1 Delay (s)	0.0	0.0		0.0	0.0	0.0	0.0	0.0		0.0	0.0	0.0
Turn Type	pm+pt	NA		pm+pt	NA	custom	pm+pt	NA		Prot	NA	custom
Protected Phases	3	8		7	4		1	6		5	2	3
Permitted Phases	8			4		8	6					6
Detector Phase	3	8		7	4	8	1			5		
Switch Phase												

Lanes, Volumes, Timings
2: Alton Rd & Dade Blvd

3/31/2015

Lane Group	EBL	EBT	EBR	WBL	WBT	WBR	NBL	NBT	NBR	SBL	SBT	SBR
Minimum Initial (s)	5.0	7.0		5.0	7.0	7.0	5.0	7.0		5.0	7.0	5.0
Minimum Split (s)	8.0	44.4		8.0	44.4	44.4	8.0	30.8		8.0	30.8	8.0
Total Split (s)	15.0	44.4		15.0	44.4	44.4	13.0	57.6		13.0	57.6	15.0
Total Split (%)	11.5%	34.2%		11.5%	34.2%	34.2%	10.0%	44.3%		10.0%	44.3%	11.5%
Maximum Green (s)	12.0	39.0		12.0	39.0	39.0	10.0	52.8		10.0	52.8	12.0
Yellow Time (s)	3.0	4.0		3.0	4.0	4.0	3.0	4.0		3.0	4.0	3.0
All-Red Time (s)	0.0	1.4		0.0	1.4	1.4	0.0	0.8		0.0	0.8	0.0
Lost Time Adjust (s)	1.0	-1.4		1.0	-1.4	-1.4	1.0	-0.8		1.0	-0.8	1.0
Total Lost Time (s)	4.0	4.0		4.0	4.0	4.0	4.0	4.0		4.0	4.0	4.0
Lead/Lag	Lead	Lag		Lead	Lag	Lag	Lead	Lag		Lead	Lag	Lead
Lead-Lag Optimize?	Yes	Yes		Yes	Yes	Yes	Yes	Yes		Yes	Yes	Yes
Vehicle Extension (s)	2.0	2.5		2.0	2.5	2.5	2.0	1.0		2.0	1.0	2.0
Recall Mode	None	None		Max	None	None	None	C-Max		None	C-Max	None
Walk Time (s)		7.0			7.0	7.0		7.0			7.0	
Flash Dont Walk (s)		32.0			32.0	32.0		19.0			19.0	
Pedestrian Calls (#/hr)		13			21	13		23			53	
Act Effect Green (s)	38.9	28.5		40.1	29.1	28.5	73.0	66.3		8.2	67.9	76.8
Actuated g/C Ratio	0.30	0.22		0.31	0.22	0.22	0.56	0.51		0.06	0.52	0.59
v/c Ratio	0.42	0.29		1.03	0.23	0.30	0.40	1.04		0.79	0.66	0.10
Control Delay	33.2	33.8		95.3	39.3	7.8	20.0	67.2		106.6	28.9	7.6
Queue Delay	0.0	0.0		0.0	0.0	0.0	0.0	0.0		0.0	0.0	0.0
Total Delay	33.2	33.8		95.3	39.3	7.8	20.0	67.2		106.6	28.9	7.6
LOS	C	C		F	D	A	C	E		F	C	A
Approach Delay		33.5			65.4			65.0			32.2	
Approach LOS		C			E			E			C	

Intersection Summary

Area Type: CBD
 Cycle Length: 130
 Actuated Cycle Length: 130
 Offset: 65 (50%), Referenced to phase 2:SBT and 6:NBT, Start of Yellow
 Natural Cycle: 135
 Control Type: Actuated-Coordinated
 Maximum v/c Ratio: 1.04
 Intersection Signal Delay: 52.1
 Intersection LOS: D
 Intersection Capacity Utilization 111.8%
 ICU Level of Service H
 Analysis Period (min) 15
 * User Entered Value

Splits and Phases: 2: Alton Rd & Dade Blvd

ø1	ø2 (R)	ø3	ø4
13 s	57.6 s	15 s	44.4 s
ø5	ø6 (R)	ø7	ø8
13 s	57.6 s	15 s	44.4 s

Lanes, Volumes, Timings
54: Alton Rd & N Michigan Ave

3/31/2015

Lane Group	SEL	SET	SER	NWL	NWT	NWR	NEL	NET	NER	SWL	SWT	SWR
Lane Configurations												
Volume (vph)	6	4	4	12	3	609	0	1468	55	444	1236	7
Ideal Flow (vphpl)	1900	1900	1900	1900	1900	1900	1900	1900	1900	1900	1900	1900
Storage Length (ft)	0		0	0		0	100		0	215		0
Storage Lanes	0		0	0		1	1		0	1		0
Taper Length (ft)	25			25			25			25		
Lane Util. Factor	1.00	1.00	1.00	1.00	1.00	1.00	1.00	0.95	0.95	1.00	0.95	0.95
Ped Bike Factor		0.99				0.98		1.00			1.00	
Frt		0.962				0.850		0.995			0.999	
Flt Protected		0.978			0.962					0.950		
Satd. Flow (prot)	0	1551	0	0	1629	1439	1676	*3182	0	1593	3182	0
Flt Permitted		0.875			0.771					0.063		
Satd. Flow (perm)	0	1387	0	0	1305	1417	1676	*3182	0	106	3182	0
Right Turn on Red			Yes			Yes			Yes			Yes
Satd. Flow (RTOR)		5				791		5			1	
Link Speed (mph)		30			30			35			35	
Link Distance (ft)		327			632			348			307	
Travel Time (s)		7.4			14.4			6.8			6.0	
Confl. Peds. (#/hr)			12			3			1			1
Peak Hour Factor	0.79	0.79	0.79	0.77	0.77	0.77	0.99	0.99	0.99	0.95	0.95	0.95
Heavy Vehicles (%)	3%	3%	3%	1%	1%	1%	2%	2%	2%	2%	2%	2%
Adj. Flow (vph)	8	5	5	16	4	791	0	1483	56	467	1301	7
Shared Lane Traffic (%)												
Lane Group Flow (vph)	0	18	0	0	20	791	0	1539	0	467	1308	0
Enter Blocked Intersection	No	No	No	No	No	No	No	No	No	No	No	No
Lane Alignment	Left	Left	Right	Left	Left	Right	Left	Left	Right	Left	Left	Right
Median Width(ft)		0			0			12			12	
Link Offset(ft)		0			0			0			0	
Crosswalk Width(ft)		16			16			16			16	
Two way Left Turn Lane												
Headway Factor	1.14	1.14	1.14	1.14	1.14	1.14	1.14	1.14	1.14	1.14	1.14	1.14
Turning Speed (mph)	15		9	15		9	15		9	15		9
Number of Detectors	1	1		1	1	1	1	1		1	1	
Detector Template												
Leading Detector (ft)	50	50		50	50	50	50	50		50	50	
Trailing Detector (ft)	0	0		0	0	0	0	0		0	0	
Detector 1 Position(ft)	0	0		0	0	0	0	0		0	0	
Detector 1 Size(ft)	50	50		50	50	50	50	50		50	50	
Detector 1 Type	Cl+Ex	Cl+Ex		Cl+Ex	Cl+Ex	Cl+Ex	Cl+Ex	Cl+Ex		Cl+Ex	Cl+Ex	
Detector 1 Channel												
Detector 1 Extend (s)	0.0	0.0		0.0	0.0	0.0	0.0	0.0		0.0	0.0	
Detector 1 Queue (s)	0.0	0.0		0.0	0.0	0.0	0.0	0.0		0.0	0.0	
Detector 1 Delay (s)	0.0	0.0		0.0	0.0	0.0	0.0	0.0		0.0	0.0	
Turn Type	Perm	NA		Perm	NA	custom	Perm	NA		pm+pt	NA	
Protected Phases		4			4	4		2		1	1 2	
Permitted Phases	4			4		2	2			1 2		
Detector Phase	4	4		4	4	4						
Switch Phase												
Minimum Initial (s)	7.0	7.0		7.0	7.0	7.0	7.0	7.0		5.0		

Lanes, Volumes, Timings
 54: Alton Rd & N Michigan Ave

3/31/2015

Lane Group	SEL	SET	SER	NWL	NWT	NWR	NEL	NET	NER	SWL	SWT	SWR
Minimum Split (s)	37.0	37.0		37.0	37.0	37.0	26.0	26.0		8.0		
Total Split (s)	37.0	37.0		37.0	37.0	37.0	76.0	76.0		17.0		
Total Split (%)	28.5%	28.5%		28.5%	28.5%	28.5%	58.5%	58.5%		13.1%		
Maximum Green (s)	32.0	32.0		32.0	32.0	32.0	71.0	71.0		14.0		
Yellow Time (s)	4.0	4.0		4.0	4.0	4.0	4.0	4.0		3.0		
All-Red Time (s)	1.0	1.0		1.0	1.0	1.0	1.0	1.0		0.0		
Lost Time Adjust (s)		-1.0			-1.0	-1.0	-1.0	-1.0		1.0		
Total Lost Time (s)		4.0			4.0	4.0	4.0	4.0		4.0		
Lead/Lag							Lag	Lag		Lead		
Lead-Lag Optimize?							Yes	Yes		Yes		
Vehicle Extension (s)	2.5	2.5		2.5	2.5	2.5	1.0	1.0		2.0		
Recall Mode	None	None		None	None	None	C-Max	C-Max		Max		
Walk Time (s)	7.0	7.0		7.0	7.0	7.0	7.0	7.0				
Flash Dont Walk (s)	25.0	25.0		25.0	25.0	25.0	14.0	14.0				
Pedestrian Calls (#/hr)	0	0		0	0	0	0	0				
Act Effect Green (s)		9.4			9.4	81.4		72.0		108.6	112.6	
Actuated g/C Ratio		0.07			0.07	0.63		0.55		0.84	0.87	
v/c Ratio		0.17			0.21	0.67		0.87		0.92	0.47	
Control Delay		48.4			61.5	3.6		31.8		61.4	2.7	
Queue Delay		0.0			0.0	0.1		47.6		0.0	0.0	
Total Delay		48.4			61.5	3.7		79.4		61.4	2.7	
LOS		D			E	A		E		E	A	
Approach Delay		48.4			5.1			79.4			18.1	
Approach LOS		D			A			E			B	

Intersection Summary

Area Type: CBD
 Cycle Length: 130
 Actuated Cycle Length: 130
 Offset: 67 (52%), Referenced to phase 2:NESW, Start of Yellow
 Natural Cycle: 150
 Control Type: Actuated-Coordinated
 Maximum v/c Ratio: 0.92
 Intersection Signal Delay: 38.5
 Intersection LOS: D
 Intersection Capacity Utilization 112.0%
 ICU Level of Service H
 Analysis Period (min) 15
 * User Entered Value

Splits and Phases: 54: Alton Rd & N Michigan Ave

01	02 (R)	04
17 s	76 s	37 s

Lanes, Volumes, Timings
4: Dade Blvd & Michigan Ave

3/31/2015

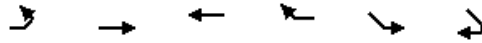

Lane Group	EBL	EBT	WBT	WBR	SEL	SER
Lane Configurations		↑↑	↑	↑↑	↑↑	
Volume (vph)	0	412	712	815	759	113
Ideal Flow (vphpl)	1900	1900	1900	1900	1900	1900
Storage Length (ft)	0			280	0	0
Storage Lanes	0			2	2	0
Taper Length (ft)	25				25	
Lane Util. Factor	1.00	0.95	1.00	0.88	0.97	0.95
Flt				0.850	0.980	
Flt Protected					0.958	
Satd. Flow (prot)	0	3505	1863	2787	3426	0
Flt Permitted					0.958	
Satd. Flow (perm)	0	3505	1863	2787	3426	0
Right Turn on Red				Yes		Yes
Satd. Flow (RTOR)					24	
Link Speed (mph)		30	30		30	
Link Distance (ft)		246	421		91	
Travel Time (s)		5.6	9.6		2.1	
Peak Hour Factor	0.94	0.94	0.98	0.98	0.93	0.93
Heavy Vehicles (%)	3%	3%	2%	2%	1%	1%
Adj. Flow (vph)	0	438	727	832	816	122
Shared Lane Traffic (%)						
Lane Group Flow (vph)	0	438	727	832	938	0
Enter Blocked Intersection	No	No	No	No	No	No
Lane Alignment	Left	Left	Left	Right	Left	Right
Median Width(ft)		0	0		24	
Link Offset(ft)		0	0		0	
Crosswalk Width(ft)		16	16		16	
Two way Left Turn Lane						
Headway Factor	1.00	1.00	1.00	1.00	1.00	1.00
Turning Speed (mph)	15			9	15	9
Number of Detectors		2	2	1	1	
Detector Template		Thru	Thru	Right	Left	
Leading Detector (ft)		100	100	20	20	
Trailing Detector (ft)		0	0	0	0	
Detector 1 Position(ft)		0	0	0	0	
Detector 1 Size(ft)		6	6	20	20	
Detector 1 Type		Cl+Ex	Cl+Ex	Cl+Ex	Cl+Ex	
Detector 1 Channel						
Detector 1 Extend (s)		0.0	0.0	0.0	0.0	
Detector 1 Queue (s)		0.0	0.0	0.0	0.0	
Detector 1 Delay (s)		0.0	0.0	0.0	0.0	
Detector 2 Position(ft)		94	94			
Detector 2 Size(ft)		6	6			
Detector 2 Type		Cl+Ex	Cl+Ex			
Detector 2 Channel						
Detector 2 Extend (s)		0.0	0.0			
Turn Type		NA	NA	pm+ov	NA	
Protected Phases		6	2	4	4	
Permitted Phases				2		

Lanes, Volumes, Timings
4: Dade Blvd & Michigan Ave

3/31/2015



Lane Group	EBL	EBT	WBT	WBR	SEL	SER
Detector Phase		6	2	4	4	
Switch Phase						
Minimum Initial (s)		4.0	4.0	4.0	4.0	
Minimum Split (s)		34.8	34.8	20.6	20.6	
Total Split (s)		45.8	45.8	54.2	54.2	
Total Split (%)		45.8%	45.8%	54.2%	54.2%	
Maximum Green (s)		41.0	41.0	49.6	49.6	
Yellow Time (s)		4.0	4.0	4.0	4.0	
All-Red Time (s)		0.8	0.8	0.6	0.6	
Lost Time Adjust (s)		0.0	0.0	0.0	0.0	
Total Lost Time (s)		4.8	4.8	4.6	4.6	
Lead/Lag						
Lead-Lag Optimize?						
Vehicle Extension (s)		1.0	1.0	2.5	2.5	
Recall Mode		Min	Min	None	None	
Walk Time (s)		7.0	7.0			
Flash Dont Walk (s)		23.0	23.0			
Pedestrian Calls (#/hr)		0	0			
Act Effect Green (s)		34.0	34.0	72.1	28.3	
Actuated g/C Ratio		0.47	0.47	1.00	0.39	
v/c Ratio		0.26	0.83	0.30	0.69	
Control Delay		12.7	27.4	0.3	21.3	
Queue Delay		0.0	0.0	0.0	0.0	
Total Delay		12.7	27.4	0.3	21.3	
LOS		B	C	A	C	
Approach Delay		12.7	12.9		21.3	
Approach LOS		B	B		C	

Intersection Summary

Area Type:	Other
Cycle Length:	100
Actuated Cycle Length:	72.1
Natural Cycle:	60
Control Type:	Semi Act-Uncoord
Maximum v/c Ratio:	0.83
Intersection Signal Delay:	15.6
Intersection Capacity Utilization	70.5%
Analysis Period (min)	15
Intersection LOS:	B
ICU Level of Service	C

Splits and Phases: 4: Dade Blvd & Michigan Ave

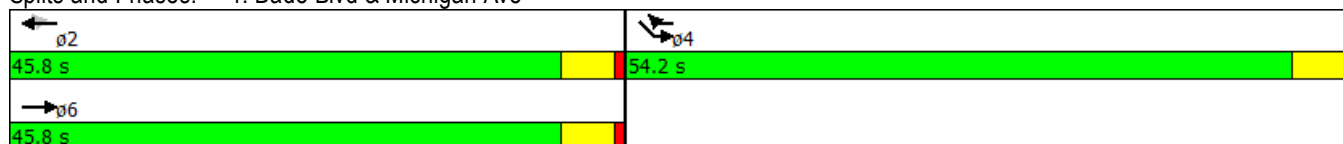

Intersection

Intersection Delay, s/veh 0.5

Movement	EBL	EBR	SET	SER	NWL	NWT
Vol, veh/h	0	69	759	107	0	815
Conflicting Peds, #/hr	0	0	0	0	0	0
Sign Control	Stop	Stop	Free	Free	Free	Free
RT Channelized	-	None	-	None	-	None
Storage Length	-	0	-	-	-	-
Veh in Median Storage, #	0	-	0	-	-	0
Grade, %	0	-	0	-	-	0
Peak Hour Factor	93	93	93	93	93	93
Heavy Vehicles, %	2	2	1	1	2	2
Mvmt Flow	0	74	816	115	0	876

Major/Minor	Minor1	Major1	Major2
Conflicting Flow All	1312	466	0
Stage 1	874	-	-
Stage 2	438	-	-
Follow-up Headway	4	3	-
Pot Capacity-1 Maneuver	150	543	-
Stage 1	369	-	-
Stage 2	618	-	-
Time blocked-Platoon, %			-
Mov Capacity-1 Maneuver	150	543	-
Mov Capacity-2 Maneuver	150	-	-
Stage 1	369	-	-
Stage 2	618	-	-

Approach	EB	SE	NW
HCM Control Delay, s	13	0	0

Minor Lane / Major Mvmt	NWL	NWT	EBLn1	SET	SER
Capacity (veh/h)	731	-	543	-	-
HCM Lane V/C Ratio	-	-	0.137	-	-
HCM Control Delay (s)	0	-	12.7	-	-
HCM Lane LOS	A		B		
HCM 95th % tile Q(veh)	0	-	0.471	-	-

Notes

~ : Volume Exceeds Capacity; \$: Delay Exceeds 300 Seconds; Error : Computation Not Defined

Intersection

Intersection Delay, s/veh 0.6

Movement	WBL	WBR	NBR	SWL
Vol, veh/h	0	66	1426	1007
Conflicting Peds, #/hr	0	0	0	0
Sign Control	Stop	Stop	Free	Free
RT Channelized	-	None	-	None
Storage Length	-	0	-	-
Veh in Median Storage, #	0	-	0	0
Grade, %	0	-	0	0
Peak Hour Factor	80	80	98	90
Heavy Vehicles, %	2	2	2	2
Mvmt Flow	0	82	1455	1119

Major/Minor	Minor1	Major1	Major2
Conflicting Flow All	2078	792	0 1584
Stage 1	1519	-	- -
Stage 2	559	-	- -
Follow-up Headway	4	3	- 2
Pot Capacity-1 Maneuver	46	332	- 411
Stage 1	167	-	- -
Stage 2	536	-	- -
Time blocked-Platoon, %			-
Mov Capacity-1 Maneuver	46	332	- 411
Mov Capacity-2 Maneuver	46	-	- -
Stage 1	167	-	- -
Stage 2	536	-	- -

Approach	WB	NB	SW
HCM Control Delay, s	19	0	0

Minor Lane / Major Mvmt	NBR	NBR2	WBLn1	SWL2	SWL
Capacity (veh/h)	-	-	332	411	-
HCM Lane V/C Ratio	-	-	0.248	-	-
HCM Control Delay (s)	-	-	19.4	0	-
HCM Lane LOS			C	A	
HCM 95th % tile Q(veh)	-	-	0.962	0	-

Notes

~ : Volume Exceeds Capacity; \$: Delay Exceeds 300 Seconds; Error : Computation Not Defined

Lanes, Volumes, Timings
54: Alton Rd & N Michigan Ave

3/31/2015

Lane Group	SEL	SET	SER	NWL	NWT	NWR	NEL	NET	NER	SWL	SWT	SWR
Lane Configurations		↕			↕	↕	↕	↕↕		↕↕	↕↕	
Volume (vph)	6	4	4	13	3	621	0	1498	56	453	1261	7
Ideal Flow (vphpl)	1900	1900	1900	1900	1900	1900	1900	1900	1900	1900	1900	1900
Storage Length (ft)	0		0	0		0	100		0	215		0
Storage Lanes	0		0	0		1	1		0	2		0
Taper Length (ft)	25			25			25			25		
Lane Util. Factor	1.00	1.00	1.00	1.00	1.00	1.00	1.00	0.95	0.95	0.97	0.95	0.95
Ped Bike Factor		0.99				0.98		1.00			1.00	
Frt		0.962				0.850		0.995			0.999	
Flt Protected		0.978			0.961					0.950		
Satd. Flow (prot)	0	1551	0	0	1627	1439	1676	*3800	0	3090	3182	0
Flt Permitted		0.874			0.767					0.950		
Satd. Flow (perm)	0	1386	0	0	1299	1417	1676	3168	0	3090	3182	0
Right Turn on Red			Yes			Yes			Yes			Yes
Satd. Flow (RTOR)		5				806		5			1	
Link Speed (mph)		30			30			35			35	
Link Distance (ft)		327			632			348			307	
Travel Time (s)		7.4			14.4			6.8			6.0	
Confl. Peds. (#/hr)			12			3			1			1
Peak Hour Factor	0.79	0.79	0.79	0.77	0.77	0.77	0.99	0.99	0.99	0.95	0.95	0.95
Heavy Vehicles (%)	3%	3%	3%	1%	1%	1%	2%	2%	2%	2%	2%	2%
Adj. Flow (vph)	8	5	5	17	4	806	0	1513	57	477	1327	7
Shared Lane Traffic (%)												
Lane Group Flow (vph)	0	18	0	0	21	806	0	1570	0	477	1334	0
Enter Blocked Intersection	No	No	No	No	No	No	No	No	No	No	No	No
Lane Alignment	Left	Left	Right	Left	Left	Right	Left	Left	Right	Left	Left	Right
Median Width(ft)		0			0			24			24	
Link Offset(ft)		0			0			0			0	
Crosswalk Width(ft)		16			16			16			16	
Two way Left Turn Lane												
Headway Factor	1.14	1.14	1.14	1.14	1.14	1.14	1.14	1.14	1.14	1.14	1.14	1.14
Turning Speed (mph)	15		9	15		9	15		9	15		9
Number of Detectors	1	1		1	1	1	1	1		1	1	
Detector Template												
Leading Detector (ft)	50	50		50	50	50	50	50		50	50	
Trailing Detector (ft)	0	0		0	0	0	0	0		0	0	
Detector 1 Position(ft)	0	0		0	0	0	0	0		0	0	
Detector 1 Size(ft)	50	50		50	50	50	50	50		50	50	
Detector 1 Type	Cl+Ex	Cl+Ex		Cl+Ex	Cl+Ex	Cl+Ex	Cl+Ex	Cl+Ex		Cl+Ex	Cl+Ex	
Detector 1 Channel												
Detector 1 Extend (s)	0.0	0.0		0.0	0.0	0.0	0.0	0.0		0.0	0.0	
Detector 1 Queue (s)	0.0	0.0		0.0	0.0	0.0	0.0	0.0		0.0	0.0	
Detector 1 Delay (s)	0.0	0.0		0.0	0.0	0.0	0.0	0.0		0.0	0.0	
Turn Type	Perm	NA		Perm	NA	custom	Perm	NA		Prot	NA	
Protected Phases		4			4	4		2		1	1	2
Permitted Phases	4			4		2	2					
Detector Phase	4	4		4	4	4						
Switch Phase												
Minimum Initial (s)	7.0	7.0		7.0	7.0	7.0	7.0	7.0		5.0		

Lanes, Volumes, Timings
 54: Alton Rd & N Michigan Ave

3/31/2015

Lane Group	SEL	SET	SER	NWL	NWT	NWR	NEL	NET	NER	SWL	SWT	SWR
Minimum Split (s)	37.0	37.0		37.0	37.0	37.0	26.0	26.0		8.0		
Total Split (s)	37.0	37.0		37.0	37.0	37.0	76.0	76.0		17.0		
Total Split (%)	28.5%	28.5%		28.5%	28.5%	28.5%	58.5%	58.5%		13.1%		
Maximum Green (s)	32.0	32.0		32.0	32.0	32.0	71.0	71.0		14.0		
Yellow Time (s)	4.0	4.0		4.0	4.0	4.0	4.0	4.0		3.0		
All-Red Time (s)	1.0	1.0		1.0	1.0	1.0	1.0	1.0		0.0		
Lost Time Adjust (s)		-1.0			-1.0	-1.0	-1.0	-1.0		1.0		
Total Lost Time (s)		4.0			4.0	4.0	4.0	4.0		4.0		
Lead/Lag							Lag	Lag		Lead		
Lead-Lag Optimize?							Yes	Yes		Yes		
Vehicle Extension (s)	2.5	2.5		2.5	2.5	2.5	1.0	1.0		2.0		
Recall Mode	None	None		None	None	None	C-Max	C-Max		Max		
Walk Time (s)	7.0	7.0		7.0	7.0	7.0	7.0	7.0				
Flash Dont Walk (s)	25.0	25.0		25.0	25.0	25.0	14.0	14.0				
Pedestrian Calls (#/hr)	0	0		0	0	0	0	0				
Act Effect Green (s)		9.4			9.4	81.4		72.0		36.6	112.6	
Actuated g/C Ratio		0.07			0.07	0.63		0.55		0.28	0.87	
v/c Ratio		0.17			0.23	0.68		0.75		0.55	0.48	
Control Delay		48.2			61.8	3.7		24.8		42.9	2.8	
Queue Delay		0.0			0.0	0.1		48.6		0.0	0.0	
Total Delay		48.2			61.8	3.8		73.4		42.9	2.8	
LOS		D			E	A		E		D	A	
Approach Delay		48.2			5.3			73.4			13.3	
Approach LOS		D			A			E			B	

Intersection Summary

Area Type: CBD
 Cycle Length: 130
 Actuated Cycle Length: 130
 Offset: 67 (52%), Referenced to phase 2:NESW, Start of Yellow
 Natural Cycle: 100
 Control Type: Actuated-Coordinated
 Maximum v/c Ratio: 0.75
 Intersection Signal Delay: 34.2
 Intersection LOS: C
 Intersection Capacity Utilization 113.7%
 ICU Level of Service H
 Analysis Period (min) 15
 * User Entered Value

Splits and Phases: 54: Alton Rd & N Michigan Ave

01	02 (R)	04
17 s	76 s	37 s

Lanes, Volumes, Timings
4: Dade Blvd & Michigan Ave

3/31/2015

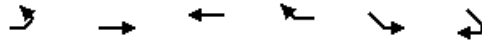

Lane Group	EBL	EBT	WBT	WBR	SEL	SER
Lane Configurations		↑↑	↑	↑↑	↑↑	
Volume (vph)	0	420	727	832	774	116
Ideal Flow (vphpl)	1900	1900	1900	1900	1900	1900
Storage Length (ft)	0			280	0	0
Storage Lanes	0			2	2	0
Taper Length (ft)	25				25	
Lane Util. Factor	1.00	0.95	1.00	0.88	0.97	0.95
Flt				0.850	0.980	
Flt Protected					0.958	
Satd. Flow (prot)	0	3539	1863	2787	3426	0
Flt Permitted					0.958	
Satd. Flow (perm)	0	3539	1863	2787	3426	0
Right Turn on Red				Yes		Yes
Satd. Flow (RTOR)					24	
Link Speed (mph)		30	30		30	
Link Distance (ft)		246	421		91	
Travel Time (s)		5.6	9.6		2.1	
Peak Hour Factor	0.94	0.94	0.98	0.98	0.93	0.93
Heavy Vehicles (%)	3%	2%	2%	2%	1%	1%
Adj. Flow (vph)	0	447	742	849	832	125
Shared Lane Traffic (%)						
Lane Group Flow (vph)	0	447	742	849	957	0
Enter Blocked Intersection	No	No	No	No	No	No
Lane Alignment	Left	Left	Left	Right	Left	Right
Median Width(ft)		0	0		24	
Link Offset(ft)		0	0		0	
Crosswalk Width(ft)		16	16		16	
Two way Left Turn Lane						
Headway Factor	1.00	1.00	1.00	1.00	1.00	1.00
Turning Speed (mph)	15			9	15	9
Number of Detectors		2	2	1	1	
Detector Template		Thru	Thru	Right	Left	
Leading Detector (ft)		100	100	20	20	
Trailing Detector (ft)		0	0	0	0	
Detector 1 Position(ft)		0	0	0	0	
Detector 1 Size(ft)		6	6	20	20	
Detector 1 Type		Cl+Ex	Cl+Ex	Cl+Ex	Cl+Ex	
Detector 1 Channel						
Detector 1 Extend (s)		0.0	0.0	0.0	0.0	
Detector 1 Queue (s)		0.0	0.0	0.0	0.0	
Detector 1 Delay (s)		0.0	0.0	0.0	0.0	
Detector 2 Position(ft)		94	94			
Detector 2 Size(ft)		6	6			
Detector 2 Type		Cl+Ex	Cl+Ex			
Detector 2 Channel						
Detector 2 Extend (s)		0.0	0.0			
Turn Type		NA	NA	pm+ov	NA	
Protected Phases		6	2	4	4	
Permitted Phases				2		

Lanes, Volumes, Timings
4: Dade Blvd & Michigan Ave

3/31/2015

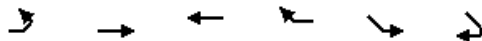

Lane Group	EBL	EBT	WBT	WBR	SEL	SER
Detector Phase		6	2	4	4	
Switch Phase						
Minimum Initial (s)		7.0	7.0	14.0	14.0	
Minimum Split (s)		34.8	34.8	20.6	20.6	
Total Split (s)		45.8	45.8	54.2	54.2	
Total Split (%)		45.8%	45.8%	54.2%	54.2%	
Maximum Green (s)		41.0	41.0	49.6	49.6	
Yellow Time (s)		4.0	4.0	4.0	4.0	
All-Red Time (s)		0.8	0.8	0.6	0.6	
Lost Time Adjust (s)		0.0	0.0	0.0	0.0	
Total Lost Time (s)		4.8	4.8	4.6	4.6	
Lead/Lag						
Lead-Lag Optimize?						
Vehicle Extension (s)		1.0	1.0	2.5	2.5	
Recall Mode		Min	Min	None	None	
Walk Time (s)		7.0	7.0			
Flash Dont Walk (s)		23.0	23.0			
Pedestrian Calls (#/hr)		0	0			
Act Effct Green (s)		35.9	35.9	74.5	28.9	
Actuated g/C Ratio		0.48	0.48	1.00	0.39	
v/c Ratio		0.26	0.83	0.30	0.71	
Control Delay		12.7	27.7	0.3	22.4	
Queue Delay		0.0	0.0	0.0	0.0	
Total Delay		12.7	27.7	0.3	22.4	
LOS		B	C	A	C	
Approach Delay		12.7	13.1		22.4	
Approach LOS		B	B		C	

Intersection Summary

Area Type:	Other
Cycle Length:	100
Actuated Cycle Length:	74.5
Natural Cycle:	60
Control Type:	Semi Act-Uncoord
Maximum v/c Ratio:	0.83
Intersection Signal Delay:	16.0
Intersection Capacity Utilization	71.8%
Analysis Period (min)	15
Intersection LOS:	B
ICU Level of Service	C

Splits and Phases: 4: Dade Blvd & Michigan Ave

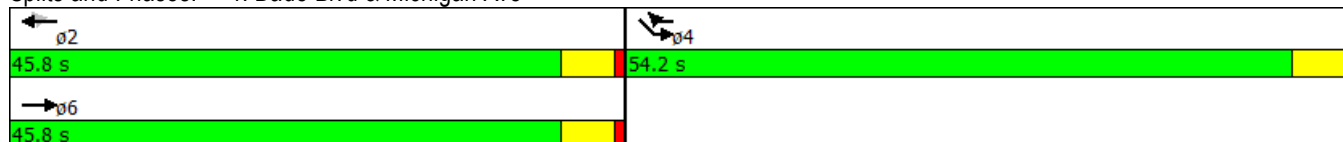

Intersection

Intersection Delay, s/veh	0.5
---------------------------	-----

Movement	EBL	EBR	SET	SER	NWL	NWT
Vol, veh/h	0	71	774	109	0	832
Conflicting Peds, #/hr	0	0	0	0	0	0
Sign Control	Stop	Stop	Free	Free	Free	Free
RT Channelized	-	None	-	None	-	None
Storage Length	-	0	-	-	-	-
Veh in Median Storage, #	0	-	0	-	-	0
Grade, %	0	-	0	-	-	0
Peak Hour Factor	93	93	93	93	93	93
Heavy Vehicles, %	2	2	1	1	2	2
Mvmt Flow	0	76	832	117	0	895

Major/Minor	Minor1	Major1	Major2
Conflicting Flow All	1338	475	0
Stage 1	891	-	-
Stage 2	447	-	-
Follow-up Headway	4	3	-
Pot Capacity-1 Maneuver	144	536	-
Stage 1	361	-	-
Stage 2	611	-	-
Time blocked-Platoon, %			
Mov Capacity-1 Maneuver	144	536	-
Mov Capacity-2 Maneuver	144	-	-
Stage 1	361	-	-
Stage 2	611	-	-

Approach	EB	SE	NW
HCM Control Delay, s	13	0	0

Minor Lane / Major Mvmt	NWL	NWT	EBLn1	SET	SER
Capacity (veh/h)	719	-	536	-	-
HCM Lane V/C Ratio	-	-	0.142	-	-
HCM Control Delay (s)	0	-	12.8	-	-
HCM Lane LOS	A		B		
HCM 95th % tile Q(veh)	0	-	0.494	-	-

Notes

~ : Volume Exceeds Capacity; \$: Delay Exceeds 300 Seconds; Error : Computation Not Defined

Intersection

Intersection Delay, s/veh 0.6

Movement	WBL	WBR	NBR	SWL
Vol, veh/h	0	67	1455	1027
Conflicting Peds, #/hr	0	0	0	0
Sign Control	Stop	Stop	Free	Free
RT Channelized	-	None	-	None
Storage Length	-	0	-	-
Veh in Median Storage, #	0	-	0	0
Grade, %	0	-	0	0
Peak Hour Factor	80	80	98	90
Heavy Vehicles, %	2	2	2	2
Mvmt Flow	0	84	1485	1141

Major/Minor	Minor1	Major1	Major2
Conflicting Flow All	2121	808	0 1615
Stage 1	1550	-	- -
Stage 2	571	-	- -
Follow-up Headway	4	3	- 2
Pot Capacity-1 Maneuver	43	324	- 400
Stage 1	161	-	- -
Stage 2	529	-	- -
Time blocked-Platoon, %			-
Mov Capacity-1 Maneuver	43	324	- 400
Mov Capacity-2 Maneuver	43	-	- -
Stage 1	161	-	- -
Stage 2	529	-	- -

Approach	WB	NB	SW
HCM Control Delay, s	20	0	0

Minor Lane / Major Mvmt	NBR	NBR2	WBLn1	SWL2	SWL
Capacity (veh/h)	-	-	324	400	-
HCM Lane V/C Ratio	-	-	0.258	-	-
HCM Control Delay (s)	-	-	19.9	0	-
HCM Lane LOS			C	A	
HCM 95th % tile Q(veh)	-	-	1.012	0	-

Notes

~ : Volume Exceeds Capacity; \$: Delay Exceeds 300 Seconds; Error : Computation Not Defined

Lanes, Volumes, Timings

2: Alton Rd & Dade Blvd

3/31/2015

Lane Group	EBL	EBT	EBR	WBL	WBT	WBR	NBL	NBT	NBR	SBL	SBT	SBR
Lane Configurations												
Volume (vph)	177	123	37	325	145	161	75	1405	195	74	1070	78
Ideal Flow (vphpl)	1900	1900	1900	1900	1900	1900	1900	1900	1900	1900	1900	1900
Lane Width (ft)	11	12	12	11	12	12	11	12	12	11	12	12
Storage Length (ft)	220		0	185		60	0		0	0		70
Storage Lanes	1		0	1		1	1		0	1		1
Taper Length (ft)	25			25			25			25		
Lane Util. Factor	1.00	0.95	0.95	1.00	0.95	1.00	1.00	0.95	0.95	1.00	0.95	1.00
Ped Bike Factor		0.99				0.93		1.00				0.96
Fr _t		0.965				0.850		0.982				0.850
Flt Protected	0.950			0.950			0.950			0.950		
Satd. Flow (prot)	1525	3000	0	*1525	3185	1425	1540	*3185	0	1540	3185	1425
Flt Permitted	0.619			0.571			0.155			0.950		
Satd. Flow (perm)	993	3000	0	*981	3185	1331	251	*3185	0	1540	3185	1370
Right Turn on Red			Yes			Yes			Yes			Yes
Satd. Flow (RTOR)		31				183		14				45
Link Speed (mph)		30			30			35			35	
Link Distance (ft)		737			978			249			313	
Travel Time (s)		16.8			22.2			4.9			6.1	
Confl. Peds. (#/hr)			52			55			14			18
Peak Hour Factor	0.80	0.80	0.80	0.88	0.88	0.88	0.87	0.87	0.87	0.95	0.95	0.95
Heavy Vehicles (%)	3%	3%	3%	2%	2%	2%	2%	2%	2%	2%	2%	2%
Adj. Flow (vph)	221	154	46	369	165	183	86	1615	224	78	1126	82
Shared Lane Traffic (%)												
Lane Group Flow (vph)	221	200	0	369	165	183	86	1839	0	78	1126	82
Enter Blocked Intersection	No	No	No	No	No	No	No	No	No	No	No	No
Lane Alignment	Left	Left	Right	Left	Left	Right	Left	Left	Right	Left	Left	Right
Median Width(ft)		11			11			11			11	
Link Offset(ft)		0			0			0			0	
Crosswalk Width(ft)		16			16			16			16	
Two way Left Turn Lane												
Headway Factor	1.19	1.14	1.14	1.19	1.14	1.14	1.19	1.14	1.14	1.19	1.14	1.14
Turning Speed (mph)	15		9	15		9	15		9	15		9
Number of Detectors	1	1		1	1	1	1	1		1	1	1
Detector Template												
Leading Detector (ft)	50	50		50	50	50	50	50		50	50	50
Trailing Detector (ft)	0	0		0	0	0	0	0		0	0	0
Detector 1 Position(ft)	0	0		0	0	0	0	0		0	0	0
Detector 1 Size(ft)	50	50		50	50	50	50	50		50	50	50
Detector 1 Type	Cl+Ex	Cl+Ex		Cl+Ex	Cl+Ex	Cl+Ex	Cl+Ex	Cl+Ex		Cl+Ex	Cl+Ex	Cl+Ex
Detector 1 Channel												
Detector 1 Extend (s)	0.0	0.0		0.0	0.0	0.0	0.0	0.0		0.0	0.0	0.0
Detector 1 Queue (s)	0.0	0.0		0.0	0.0	0.0	0.0	0.0		0.0	0.0	0.0
Detector 1 Delay (s)	0.0	0.0		0.0	0.0	0.0	0.0	0.0		0.0	0.0	0.0
Turn Type	pm+pt	NA		pm+pt	NA	custom	pm+pt	NA		Prot	NA	custom
Protected Phases	3	8		7	4		1	6		5	2	3
Permitted Phases	8			4		8	6					6
Detector Phase	3	8		7	4	8	1			5		
Switch Phase												

Lanes, Volumes, Timings
2: Alton Rd & Dade Blvd

3/31/2015

Lane Group	EBL	EBT	EBR	WBL	WBT	WBR	NBL	NBT	NBR	SBL	SBT	SBR
Minimum Initial (s)	5.0	7.0		5.0	7.0	7.0	5.0	7.0		5.0	7.0	5.0
Minimum Split (s)	8.0	44.4		8.0	44.4	44.4	8.0	30.8		8.0	30.8	8.0
Total Split (s)	15.0	44.4		15.0	44.4	44.4	13.0	57.6		13.0	57.6	15.0
Total Split (%)	11.5%	34.2%		11.5%	34.2%	34.2%	10.0%	44.3%		10.0%	44.3%	11.5%
Maximum Green (s)	12.0	39.0		12.0	39.0	39.0	10.0	52.8		10.0	52.8	12.0
Yellow Time (s)	3.0	4.0		3.0	4.0	4.0	3.0	4.0		3.0	4.0	3.0
All-Red Time (s)	0.0	1.4		0.0	1.4	1.4	0.0	0.8		0.0	0.8	0.0
Lost Time Adjust (s)	1.0	-1.4		1.0	-1.4	-1.4	1.0	-0.8		1.0	-0.8	1.0
Total Lost Time (s)	4.0	4.0		4.0	4.0	4.0	4.0	4.0		4.0	4.0	4.0
Lead/Lag	Lead	Lag		Lead	Lag	Lag	Lead	Lag		Lead	Lag	Lead
Lead-Lag Optimize?	Yes	Yes		Yes	Yes	Yes	Yes	Yes		Yes	Yes	Yes
Vehicle Extension (s)	2.0	2.5		2.0	2.5	2.5	2.0	1.0		2.0	1.0	2.0
Recall Mode	None	None		Max	None	None	None	C-Max		None	C-Max	None
Walk Time (s)		7.0			7.0	7.0		7.0			7.0	
Flash Dont Walk (s)		32.0			32.0	32.0		19.0			19.0	
Pedestrian Calls (#/hr)		13			21	13		23			53	
Act Effect Green (s)	39.6	28.6		39.6	28.6	28.6	72.9	66.2		8.3	67.7	77.2
Actuated g/C Ratio	0.30	0.22		0.30	0.22	0.22	0.56	0.51		0.06	0.52	0.59
v/c Ratio	0.64	0.29		1.07	0.24	0.42	0.42	1.13		0.80	0.68	0.10
Control Delay	41.6	34.0		107.5	39.7	7.6	20.7	97.7		107.8	29.4	7.8
Queue Delay	0.0	0.0		0.0	0.0	0.0	0.0	0.0		0.0	0.0	0.0
Total Delay	41.6	34.0		107.5	39.7	7.6	20.7	97.7		107.8	29.4	7.8
LOS	D	C		F	D	A	C	F		F	C	A
Approach Delay		38.0			66.4			94.3			32.7	
Approach LOS		D			E			F			C	

Intersection Summary

Area Type: CBD
 Cycle Length: 130
 Actuated Cycle Length: 130
 Offset: 65 (50%), Referenced to phase 2:SBT and 6:NBT, Start of Yellow
 Natural Cycle: 145
 Control Type: Actuated-Coordinated
 Maximum v/c Ratio: 1.13
 Intersection Signal Delay: 66.0
 Intersection Capacity Utilization 115.9%
 Analysis Period (min) 15
 * User Entered Value
 Intersection LOS: E
 ICU Level of Service H

Splits and Phases: 2: Alton Rd & Dade Blvd

ø1	ø2 (R)	ø3	ø4
13 s	57.6 s	15 s	44.4 s
ø5	ø6 (R)	ø7	ø8
13 s	57.6 s	15 s	44.4 s

Lanes, Volumes, Timings
54: Alton Rd & N Michigan Ave

3/31/2015

Lane Group	SEL	SET	SER	NWL	NWT	NWR	NEL	NET	NER	SWL	SWT	SWR
Lane Configurations		↕			↕	↕	↕	↕↕		↕↕	↕↕	
Volume (vph)	6	19	4	13	3	621	14	1554	71	511	1261	7
Ideal Flow (vphpl)	1900	1900	1900	1900	1900	1900	1900	1900	1900	1900	1900	1900
Storage Length (ft)	0		0	0		0	100		0	215		0
Storage Lanes	0		0	0		1	1		0	2		0
Taper Length (ft)	25			25			25			25		
Lane Util. Factor	1.00	1.00	1.00	1.00	1.00	1.00	1.00	0.95	0.95	0.97	0.95	0.95
Ped Bike Factor		1.00				0.98		1.00			1.00	
Frt		0.982				0.850		0.993			0.999	
Flt Protected		0.989			0.961		0.950			0.950		
Satd. Flow (prot)	0	1607	0	0	1627	1439	1593	*3182	0	3090	3182	0
Flt Permitted		0.937			0.852		0.205			0.950		
Satd. Flow (perm)	0	1522	0	0	1442	1417	344	*3182	0	3090	3182	0
Right Turn on Red			Yes			Yes			Yes			Yes
Satd. Flow (RTOR)		5				806		6			1	
Link Speed (mph)		30			30			35			35	
Link Distance (ft)		327			632			348			307	
Travel Time (s)		7.4			14.4			6.8			6.0	
Confl. Peds. (#/hr)			12			3			1			1
Peak Hour Factor	0.79	0.79	0.79	0.77	0.77	0.77	0.99	0.99	0.99	0.95	0.95	0.95
Heavy Vehicles (%)	3%	3%	3%	1%	1%	1%	2%	2%	2%	2%	2%	2%
Adj. Flow (vph)	8	24	5	17	4	806	14	1570	72	538	1327	7
Shared Lane Traffic (%)												
Lane Group Flow (vph)	0	37	0	0	21	806	14	1642	0	538	1334	0
Enter Blocked Intersection	No	No	No	No	No	No	No	No	No	No	No	No
Lane Alignment	Left	Left	Right	Left	Left	Right	Left	Left	Right	Left	Left	Right
Median Width(ft)		0			0			24			24	
Link Offset(ft)		0			0			0			0	
Crosswalk Width(ft)		16			16			16			16	
Two way Left Turn Lane												
Headway Factor	1.14	1.14	1.14	1.14	1.14	1.14	1.14	1.14	1.14	1.14	1.14	1.14
Turning Speed (mph)	15		9	15		9	15		9	15		9
Number of Detectors	1	1		1	1	1	1	1		1	1	
Detector Template												
Leading Detector (ft)	50	50		50	50	50	50	50		50	50	
Trailing Detector (ft)	0	0		0	0	0	0	0		0	0	
Detector 1 Position(ft)	0	0		0	0	0	0	0		0	0	
Detector 1 Size(ft)	50	50		50	50	50	50	50		50	50	
Detector 1 Type	Cl+Ex	Cl+Ex		Cl+Ex	Cl+Ex	Cl+Ex	Cl+Ex	Cl+Ex		Cl+Ex	Cl+Ex	
Detector 1 Channel												
Detector 1 Extend (s)	0.0	0.0		0.0	0.0	0.0	0.0	0.0		0.0	0.0	
Detector 1 Queue (s)	0.0	0.0		0.0	0.0	0.0	0.0	0.0		0.0	0.0	
Detector 1 Delay (s)	0.0	0.0		0.0	0.0	0.0	0.0	0.0		0.0	0.0	
Turn Type	Perm	NA		Perm	NA	custom	Perm	NA		Prot	NA	
Protected Phases		4			4	4		2		1	1	2
Permitted Phases	4			4		2	2					
Detector Phase	4	4		4	4	4						
Switch Phase												
Minimum Initial (s)	7.0	7.0		7.0	7.0	7.0	7.0	7.0		5.0		

Lanes, Volumes, Timings
54: Alton Rd & N Michigan Ave

3/31/2015

Lane Group	SEL	SET	SER	NWL	NWT	NWR	NEL	NET	NER	SWL	SWT	SWR
Minimum Split (s)	37.0	37.0		37.0	37.0	37.0	26.0	26.0		8.0		
Total Split (s)	37.0	37.0		37.0	37.0	37.0	76.0	76.0		17.0		
Total Split (%)	28.5%	28.5%		28.5%	28.5%	28.5%	58.5%	58.5%		13.1%		
Maximum Green (s)	32.0	32.0		32.0	32.0	32.0	71.0	71.0		14.0		
Yellow Time (s)	4.0	4.0		4.0	4.0	4.0	4.0	4.0		3.0		
All-Red Time (s)	1.0	1.0		1.0	1.0	1.0	1.0	1.0		0.0		
Lost Time Adjust (s)		-1.0			-1.0	-1.0	-1.0	-1.0		1.0		
Total Lost Time (s)		4.0			4.0	4.0	4.0	4.0		4.0		
Lead/Lag							Lag	Lag		Lead		
Lead-Lag Optimize?							Yes	Yes		Yes		
Vehicle Extension (s)	2.5	2.5		2.5	2.5	2.5	1.0	1.0		2.0		
Recall Mode	None	None		None	None	None	C-Max	C-Max		Max		
Walk Time (s)	7.0	7.0		7.0	7.0	7.0	7.0	7.0				
Flash Dont Walk (s)	25.0	25.0		25.0	25.0	25.0	14.0	14.0				
Pedestrian Calls (#/hr)	0	0		0	0	0	0	0				
Act Effect Green (s)		10.3			10.3	82.3	72.0	72.0		35.7	111.7	
Actuated g/C Ratio		0.08			0.08	0.63	0.55	0.55		0.27	0.86	
v/c Ratio		0.30			0.18	0.68	0.07	0.93		0.63	0.49	
Control Delay		55.6			58.4	3.6	14.9	37.4		45.9	3.0	
Queue Delay		0.0			0.0	0.1	0.0	45.8		0.0	0.0	
Total Delay		55.6			58.4	3.7	14.9	83.2		45.9	3.0	
LOS		E			E	A	B	F		D	A	
Approach Delay		55.6			5.1			82.6			15.4	
Approach LOS		E			A			F			B	

Intersection Summary

Area Type: CBD
 Cycle Length: 130
 Actuated Cycle Length: 130
 Offset: 67 (52%), Referenced to phase 2:NESW, Start of Yellow
 Natural Cycle: 140
 Control Type: Actuated-Coordinated
 Maximum v/c Ratio: 0.93
 Intersection Signal Delay: 39.1
 Intersection LOS: D
 Intersection Capacity Utilization 116.0%
 ICU Level of Service H
 Analysis Period (min) 15
 * User Entered Value

Splits and Phases: 54: Alton Rd & N Michigan Ave

01	02 (R)	04
17 s	76 s	37 s

Lanes, Volumes, Timings
4: Dade Blvd & Michigan Ave

3/31/2015



Lane Group	EBL	EBT	WBT	WBR	SEL	SER
Lane Configurations		↑↑	↑	↑↑	↑↑	
Volume (vph)	0	420	785	832	830	256
Ideal Flow (vphpl)	1900	1900	1900	1900	1900	1900
Storage Length (ft)	0			280	0	0
Storage Lanes	0			2	2	0
Taper Length (ft)	25				25	
Lane Util. Factor	1.00	0.95	1.00	0.88	0.97	0.95
Flt				0.850	0.965	
Flt Protected					0.963	
Satd. Flow (prot)	0	3505	1863	2787	3391	0
Flt Permitted					0.963	
Satd. Flow (perm)	0	3505	1863	2787	3391	0
Right Turn on Red				Yes		Yes
Satd. Flow (RTOR)					60	
Link Speed (mph)		30	30		30	
Link Distance (ft)		246	421		91	
Travel Time (s)		5.6	9.6		2.1	
Peak Hour Factor	0.94	0.94	0.98	0.98	0.93	0.93
Heavy Vehicles (%)	3%	3%	2%	2%	1%	1%
Adj. Flow (vph)	0	447	801	849	892	275
Shared Lane Traffic (%)						
Lane Group Flow (vph)	0	447	801	849	1167	0
Enter Blocked Intersection	No	No	No	No	No	No
Lane Alignment	Left	Left	Left	Right	Left	Right
Median Width(ft)		0	0		24	
Link Offset(ft)		0	0		0	
Crosswalk Width(ft)		16	16		16	
Two way Left Turn Lane						
Headway Factor	1.00	1.00	1.00	1.00	1.00	1.00
Turning Speed (mph)	15			9	15	9
Number of Detectors		2	2	1	1	
Detector Template		Thru	Thru	Right	Left	
Leading Detector (ft)		100	100	20	20	
Trailing Detector (ft)		0	0	0	0	
Detector 1 Position(ft)		0	0	0	0	
Detector 1 Size(ft)		6	6	20	20	
Detector 1 Type		Cl+Ex	Cl+Ex	Cl+Ex	Cl+Ex	
Detector 1 Channel						
Detector 1 Extend (s)		0.0	0.0	0.0	0.0	
Detector 1 Queue (s)		0.0	0.0	0.0	0.0	
Detector 1 Delay (s)		0.0	0.0	0.0	0.0	
Detector 2 Position(ft)		94	94			
Detector 2 Size(ft)		6	6			
Detector 2 Type		Cl+Ex	Cl+Ex			
Detector 2 Channel						
Detector 2 Extend (s)		0.0	0.0			
Turn Type		NA	NA	pm+ov	NA	
Protected Phases		6	2	4	4	
Permitted Phases				2		

Lanes, Volumes, Timings
4: Dade Blvd & Michigan Ave

3/31/2015

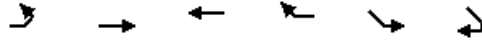

Lane Group	EBL	EBT	WBT	WBR	SEL	SER
Detector Phase		6	2	4	4	
Switch Phase						
Minimum Initial (s)		4.0	4.0	4.0	4.0	
Minimum Split (s)		34.8	34.8	20.6	20.6	
Total Split (s)		45.8	45.8	54.2	54.2	
Total Split (%)		45.8%	45.8%	54.2%	54.2%	
Maximum Green (s)		41.0	41.0	49.6	49.6	
Yellow Time (s)		4.0	4.0	4.0	4.0	
All-Red Time (s)		0.8	0.8	0.6	0.6	
Lost Time Adjust (s)		0.0	0.0	0.0	0.0	
Total Lost Time (s)		4.8	4.8	4.6	4.6	
Lead/Lag						
Lead-Lag Optimize?						
Vehicle Extension (s)		1.0	1.0	2.5	2.5	
Recall Mode		Min	Min	None	None	
Walk Time (s)		7.0	7.0			
Flash Dont Walk (s)		23.0	23.0			
Pedestrian Calls (#/hr)		0	0			
Act Effct Green (s)		41.3	41.3	87.5	36.7	
Actuated g/C Ratio		0.47	0.47	1.00	0.42	
v/c Ratio		0.27	0.91	0.30	0.80	
Control Delay		15.9	39.9	0.3	25.4	
Queue Delay		0.0	0.0	0.0	0.0	
Total Delay		15.9	39.9	0.3	25.4	
LOS		B	D	A	C	
Approach Delay		15.9	19.5		25.4	
Approach LOS		B	B		C	

Intersection Summary

Area Type:	Other
Cycle Length:	100
Actuated Cycle Length:	87.5
Natural Cycle:	75
Control Type:	Semi Act-Uncoord
Maximum v/c Ratio:	0.91
Intersection Signal Delay:	21.1
Intersection Capacity Utilization	80.9%
Analysis Period (min)	15
Intersection LOS:	C
ICU Level of Service	D

Splits and Phases: 4: Dade Blvd & Michigan Ave

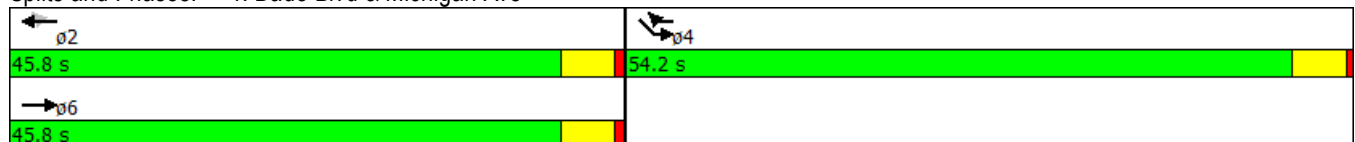

Intersection

Intersection Delay, s/veh 2.9

Movement	EBL	EBR	SET	SER	NWL	NWT
Vol, veh/h	0	267	830	197	0	832
Conflicting Peds, #/hr	0	0	0	0	0	0
Sign Control	Stop	Stop	Free	Free	Free	Free
RT Channelized	-	None	-	None	-	None
Storage Length	-	0	-	-	-	-
Veh in Median Storage, #	0	-	0	-	-	0
Grade, %	0	-	0	-	-	0
Peak Hour Factor	93	93	93	93	93	93
Heavy Vehicles, %	2	2	1	1	2	2
Mvmt Flow	0	287	892	212	0	895

Major/Minor	Minor1	Major1	Major2
Conflicting Flow All	1445	552	0
Stage 1	998	-	-
Stage 2	447	-	-
Follow-up Headway	4	3	2
Pot Capacity-1 Maneuver	123	477	628
Stage 1	317	-	-
Stage 2	611	-	-
Time blocked-Platoon, %			
Mov Capacity-1 Maneuver	123	477	628
Mov Capacity-2 Maneuver	123	-	-
Stage 1	317	-	-
Stage 2	611	-	-

Approach	EB	SE	NW
HCM Control Delay, s	23	0	0

Minor Lane / Major Mvmt	NWL	NWT	EBLn1	SET	SER
Capacity (veh/h)	628	-	477	-	-
HCM Lane V/C Ratio	-	-	0.602	-	-
HCM Control Delay (s)	0	-	23.3	-	-
HCM Lane LOS	A		C		
HCM 95th % tile Q(veh)	0	-	3.896	-	-

Notes

~ : Volume Exceeds Capacity; \$: Delay Exceeds 300 Seconds; Error : Computation Not Defined

Intersection

Intersection Delay, s/veh 2.2

Movement	WBL	WBR	NBR	SWL
Vol, veh/h	0	151	1455	1027
Conflicting Peds, #/hr	0	0	0	0
Sign Control	Stop	Stop	Free	Free
RT Channelized	-	Stop	-	None
Storage Length	-	0	-	-
Veh in Median Storage, #	0	-	0	0
Grade, %	0	-	0	0
Peak Hour Factor	80	80	98	90
Heavy Vehicles, %	2	2	2	2
Mvmt Flow	0	189	1485	1141

Major/Minor	Minor1	Major1	Major2
Conflicting Flow All	2174	860	0 1720
Stage 1	1603	-	- -
Stage 2	571	-	- -
Follow-up Headway	4	3	- 2
Pot Capacity-1 Maneuver	40	299	- 364
Stage 1	150	-	- -
Stage 2	529	-	- -
Time blocked-Platoon, %			-
Mov Capacity-1 Maneuver	40	299	- 364
Mov Capacity-2 Maneuver	40	-	- -
Stage 1	150	-	- -
Stage 2	529	-	- -

Approach	WB	NB	SW
HCM Control Delay, s	36	0	0

Minor Lane / Major Mvmt	NBR	NBR2	WBLn1	SWL2	SWL
Capacity (veh/h)	-	-	299	364	-
HCM Lane V/C Ratio	-	-	0.631	-	-
HCM Control Delay (s)	-	-	35.6	0	-
HCM Lane LOS			E	A	
HCM 95th % tile Q(veh)	-	-	3.984	0	-

Notes

~ : Volume Exceeds Capacity; \$: Delay Exceeds 300 Seconds; Error : Computation Not Defined

Intersection

Intersection Delay, s/veh 13.6

Movement	EBL	EBT	WBT	WBR	SBL	SBR
Vol, veh/h	203	32	109	88	196	84
Conflicting Peds, #/hr	0	0	0	0	0	0
Sign Control	Free	Free	Free	Free	Stop	Stop
RT Channelized	-	None	-	None	-	None
Storage Length	-	-	-	-	0	-
Veh in Median Storage, #	-	0	0	-	0	-
Grade, %	-	0	0	-	0	-
Peak Hour Factor	92	92	92	92	92	92
Heavy Vehicles, %	0	2	2	0	0	0
Mvmt Flow	221	35	118	96	213	91

Major/Minor	Major1	Major2	Minor2
Conflicting Flow All	214	0	166
Stage 1	-	-	-
Stage 2	-	-	476
Follow-up Headway	2	-	3
Pot Capacity-1 Maneuver	1368	-	884
Stage 1	-	-	868
Stage 2	-	-	629
Time blocked-Platoon, %	-	-	-
Mov Capacity-1 Maneuver	1368	-	884
Mov Capacity-2 Maneuver	-	-	-
Stage 1	-	-	868
Stage 2	-	-	525

Approach	EB	WB	SB
HCM Control Delay, s	7	0	29























Minor Lane / Major Mvmt	EBL	EBT	WBT	WBR	SBLn1
Capacity (veh/h)	1368	-	-	-	447
HCM Lane V/C Ratio	0.161	-	-	-	0.681
HCM Control Delay (s)	8.137	0	-	-	28.6
HCM Lane LOS	A	A			D
HCM 95th % tile Q(veh)	0.575	-	-	-	4.999

Notes

~ : Volume Exceeds Capacity; \$: Delay Exceeds 300 Seconds; Error : Computation Not Defined

Lanes, Volumes, Timings
2: Alton Rd & Dade Blvd

3/31/2015

												
Lane Group	EBL	EBT	EBR	WBL	WBT	WBR	NBL	NBT	NBR	SBL	SBT	SBR
Lane Configurations												
Volume (vph)	177	123	37	325	145	161	75	1405	195	74	1070	78
Ideal Flow (vphpl)	1900	1900	1900	1900	1900	1900	1900	1900	1900	1900	1900	1900
Lane Width (ft)	11	12	12	11	12	12	11	12	12	11	12	12
Storage Length (ft)	220		0	185		60	0		0	0		70
Storage Lanes	1		0	1		1	1		0	1		1
Taper Length (ft)	25			25			25			25		
Lane Util. Factor	1.00	0.95	0.95	1.00	0.95	1.00	1.00	0.95	0.95	1.00	0.95	1.00
Ped Bike Factor		0.99				0.93		1.00				0.96
Frt		0.965				0.850		0.982				0.850
Flt Protected	0.950			0.950			0.950			0.950		
Satd. Flow (prot)	1525	3000	0	*1525	3185	1425	1540	*3185	0	1540	3185	1425
Flt Permitted	0.619			0.566			0.172			0.950		
Satd. Flow (perm)	993	3000	0	*993	3185	1331	279	*3185	0	1540	3185	1370
Right Turn on Red			Yes			Yes			Yes			Yes
Satd. Flow (RTOR)		31				128		16				45
Link Speed (mph)		30			30			35			35	
Link Distance (ft)		737			978			249			313	
Travel Time (s)		16.8			22.2			4.9			6.1	
Confl. Peds. (#/hr)			52			55			14			18
Peak Hour Factor	0.80	0.80	0.80	0.88	0.88	0.88	0.87	0.87	0.87	0.95	0.95	0.95
Heavy Vehicles (%)	3%	3%	3%	2%	2%	2%	2%	2%	2%	2%	2%	2%
Adj. Flow (vph)	221	154	46	369	165	183	86	1615	224	78	1126	82
Shared Lane Traffic (%)												
Lane Group Flow (vph)	221	200	0	369	165	183	86	1839	0	78	1126	82
Enter Blocked Intersection	No	No	No	No	No	No	No	No	No	No	No	No
Lane Alignment	Left	Left	Right	Left	Left	Right	Left	Left	Right	Left	Left	Right
Median Width(ft)		11			11			11			11	
Link Offset(ft)		0			0			0			0	
Crosswalk Width(ft)		16			16			16			16	
Two way Left Turn Lane												
Headway Factor	1.19	1.14	1.14	1.19	1.14	1.14	1.19	1.14	1.14	1.19	1.14	1.14
Turning Speed (mph)	15		9	15		9	15		9	15		9
Number of Detectors	1	1		1	1	1	1	1		1	1	1
Detector Template												
Leading Detector (ft)	50	50		50	50	50	50	50		50	50	50
Trailing Detector (ft)	0	0		0	0	0	0	0		0	0	0
Detector 1 Position(ft)	0	0		0	0	0	0	0		0	0	0
Detector 1 Size(ft)	50	50		50	50	50	50	50		50	50	50
Detector 1 Type	Cl+Ex	Cl+Ex		Cl+Ex	Cl+Ex	Cl+Ex	Cl+Ex	Cl+Ex		Cl+Ex	Cl+Ex	Cl+Ex
Detector 1 Channel												
Detector 1 Extend (s)	0.0	0.0		0.0	0.0	0.0	0.0	0.0		0.0	0.0	0.0
Detector 1 Queue (s)	0.0	0.0		0.0	0.0	0.0	0.0	0.0		0.0	0.0	0.0
Detector 1 Delay (s)	0.0	0.0		0.0	0.0	0.0	0.0	0.0		0.0	0.0	0.0
Turn Type	D.P+P	NA		D.P+P	NA	custom	D.P+P	NA		Prot	NA	custom
Protected Phases	3	8		7	4		1	6		5	2	3
Permitted Phases	4			8		8	2					6
Detector Phase	3	8		7	4	8	1			5		
Switch Phase												

Lanes, Volumes, Timings

2: Alton Rd & Dade Blvd

3/31/2015

Lane Group	EBL	EBT	EBR	WBL	WBT	WBR	NBL	NBT	NBR	SBL	SBT	SBR
Minimum Initial (s)	5.0	7.0		5.0	7.0	7.0	5.0	7.0		5.0	7.0	5.0
Minimum Split (s)	8.0	42.4		8.0	42.4	42.4	8.0	30.8		8.0	30.8	8.0
Total Split (s)	10.0	42.4		11.0	43.4	42.4	10.0	67.6		9.0	66.6	10.0
Total Split (%)	7.7%	32.6%		8.5%	33.4%	32.6%	7.7%	52.0%		6.9%	51.2%	7.7%
Maximum Green (s)	7.0	37.0		8.0	38.0	37.0	7.0	62.8		6.0	61.8	7.0
Yellow Time (s)	3.0	4.0		3.0	4.0	4.0	3.0	4.0		3.0	4.0	3.0
All-Red Time (s)	0.0	1.4		0.0	1.4	1.4	0.0	0.8		0.0	0.8	0.0
Lost Time Adjust (s)	1.0	-1.4		1.0	-1.4	-1.4	1.0	-0.8		1.0	-0.8	1.0
Total Lost Time (s)	4.0	4.0		4.0	4.0	4.0	4.0	4.0		4.0	4.0	4.0
Lead/Lag	Lead	Lag		Lead	Lag	Lag	Lead	Lag		Lead	Lag	Lead
Lead-Lag Optimize?	Yes	Yes		Yes	Yes	Yes	Yes	Yes		Yes	Yes	Yes
Vehicle Extension (s)	2.0	2.5		2.0	2.5	2.5	2.0	1.0		2.0	1.0	2.0
Recall Mode	None	None		Max	None	None	None	C-Max		None	C-Max	None
Walk Time (s)		7.0			7.0	7.0		7.0			7.0	
Flash Dont Walk (s)		32.0			32.0	32.0		19.0			19.0	
Pedestrian Calls (#/hr)		13			21	13		23			53	
Act Effct Green (s)	34.3	27.3		34.3	28.3	27.3	79.7	70.6		9.1	74.3	76.6
Actuated g/C Ratio	0.26	0.21		0.26	0.22	0.21	0.61	0.54		0.07	0.57	0.59
v/c Ratio	0.77	0.31		1.27	0.24	0.48	0.39	1.06		0.73	0.62	0.10
Control Delay	57.6	35.1		182.7	40.1	16.8	17.0	68.9		94.9	23.2	6.7
Queue Delay	0.0	0.0		0.0	0.0	0.0	0.0	0.0		0.0	0.0	0.0
Total Delay	57.6	35.1		182.7	40.1	16.8	17.0	68.9		94.9	23.2	6.7
LOS	E	D		F	D	B	B	E		F	C	A
Approach Delay		46.9			107.5			66.6			26.5	
Approach LOS		D			F			E			C	

Intersection Summary

Area Type: CBD
 Cycle Length: 130
 Actuated Cycle Length: 130
 Offset: 65 (50%), Referenced to phase 2:NBSB and 6:NBT, Start of Yellow
 Natural Cycle: 150
 Control Type: Actuated-Coordinated
 Maximum v/c Ratio: 1.27
 Intersection Signal Delay: 59.6
 Intersection Capacity Utilization 115.9%
 Analysis Period (min) 15
 * User Entered Value
 Intersection LOS: E
 ICU Level of Service H

Splits and Phases: 2: Alton Rd & Dade Blvd

ø1	ø2 (R)	ø3	ø4
10 s	66.6 s	10 s	43.4 s
ø5	ø6 (R)	ø7	ø8
9 s	67.6 s	11 s	42.4 s

Lanes, Volumes, Timings
54: Alton Rd & N Michigan Ave

3/31/2015

Lane Group	SEL	SET	SER	NWL	NWT	NWR	NEL	NET	NER	SWL	SWT	SWR
Lane Configurations		↕			↕	↕	↕	↕↕		↕↕	↕↕	
Volume (vph)	6	19	4	13	3	621	14	1554	71	511	1261	7
Ideal Flow (vphpl)	1900	1900	1900	1900	1900	1900	1900	1900	1900	1900	1900	1900
Storage Length (ft)	0		0	0		0	100		0	215		0
Storage Lanes	0		0	0		1	1		0	2		0
Taper Length (ft)	25			25			25			25		
Lane Util. Factor	1.00	1.00	1.00	1.00	1.00	1.00	1.00	0.95	0.95	0.97	0.95	0.95
Ped Bike Factor		1.00				0.98		1.00			1.00	
Frt		0.982				0.850		0.993			0.999	
Flt Protected		0.989			0.961		0.950			0.950		
Satd. Flow (prot)	0	1607	0	0	1627	1439	1593	*3182	0	3090	3182	0
Flt Permitted		0.937			0.852		0.205			0.063		
Satd. Flow (perm)	0	1522	0	0	1442	1417	344	*3182	0	205	3182	0
Right Turn on Red			Yes			Yes			Yes			Yes
Satd. Flow (RTOR)		5				806		5			1	
Link Speed (mph)		30			30			35			35	
Link Distance (ft)		327			632			348			307	
Travel Time (s)		7.4			14.4			6.8			6.0	
Confl. Peds. (#/hr)			12			3			1			1
Peak Hour Factor	0.79	0.79	0.79	0.77	0.77	0.77	0.99	0.99	0.99	0.95	0.95	0.95
Heavy Vehicles (%)	3%	3%	3%	1%	1%	1%	2%	2%	2%	2%	2%	2%
Adj. Flow (vph)	8	24	5	17	4	806	14	1570	72	538	1327	7
Shared Lane Traffic (%)												
Lane Group Flow (vph)	0	37	0	0	21	806	14	1642	0	538	1334	0
Enter Blocked Intersection	No	No	No	No	No	No	No	No	No	No	No	No
Lane Alignment	Left	Left	Right	Left	Left	Right	Left	Left	Right	Left	Left	Right
Median Width(ft)		0			0			24			24	
Link Offset(ft)		0			0			0			0	
Crosswalk Width(ft)		16			16			16			16	
Two way Left Turn Lane												
Headway Factor	1.14	1.14	1.14	1.14	1.14	1.14	1.14	1.14	1.14	1.14	1.14	1.14
Turning Speed (mph)	15		9	15		9	15		9	15		9
Number of Detectors	1	1		1	1	1	1	1		1	1	
Detector Template												
Leading Detector (ft)	50	50		50	50	50	50	50		50	50	
Trailing Detector (ft)	0	0		0	0	0	0	0		0	0	
Detector 1 Position(ft)	0	0		0	0	0	0	0		0	0	
Detector 1 Size(ft)	50	50		50	50	50	50	50		50	50	
Detector 1 Type	Cl+Ex	Cl+Ex		Cl+Ex	Cl+Ex	Cl+Ex	Cl+Ex	Cl+Ex		Cl+Ex	Cl+Ex	
Detector 1 Channel												
Detector 1 Extend (s)	0.0	0.0		0.0	0.0	0.0	0.0	0.0		0.0	0.0	
Detector 1 Queue (s)	0.0	0.0		0.0	0.0	0.0	0.0	0.0		0.0	0.0	
Detector 1 Delay (s)	0.0	0.0		0.0	0.0	0.0	0.0	0.0		0.0	0.0	
Turn Type	Perm	NA		Perm	NA	custom	Perm	NA		D.P+P	NA	
Protected Phases		4			4	4		2		1	1 2	
Permitted Phases	4			4		2	2			2		
Detector Phase	4	4		4	4	4						
Switch Phase												
Minimum Initial (s)	7.0	7.0		7.0	7.0	7.0	7.0	7.0		5.0		

Lanes, Volumes, Timings
54: Alton Rd & N Michigan Ave

3/31/2015

Lane Group	SEL	SET	SER	NWL	NWT	NWR	NEL	NET	NER	SWL	SWT	SWR
Minimum Split (s)	37.0	37.0		37.0	37.0	37.0	26.0	26.0		8.0		
Total Split (s)	37.0	37.0		37.0	37.0	37.0	69.0	69.0		24.0		
Total Split (%)	28.5%	28.5%		28.5%	28.5%	28.5%	53.1%	53.1%		18.5%		
Maximum Green (s)	32.0	32.0		32.0	32.0	32.0	64.0	64.0		21.0		
Yellow Time (s)	4.0	4.0		4.0	4.0	4.0	4.0	4.0		3.0		
All-Red Time (s)	1.0	1.0		1.0	1.0	1.0	1.0	1.0		0.0		
Lost Time Adjust (s)		-1.0			-1.0	-1.0	-1.0	-1.0		1.0		
Total Lost Time (s)		4.0			4.0	4.0	4.0	4.0		4.0		
Lead/Lag							Lag	Lag		Lead		
Lead-Lag Optimize?							Yes	Yes		Yes		
Vehicle Extension (s)	2.5	2.5		2.5	2.5	2.5	1.0	1.0		2.0		
Recall Mode	None	None		None	None	None	C-Max	C-Max		Max		
Walk Time (s)	7.0	7.0		7.0	7.0	7.0	7.0	7.0				
Flash Dont Walk (s)	25.0	25.0		25.0	25.0	25.0	14.0	14.0				
Pedestrian Calls (#/hr)	0	0		0	0	0	0	0				
Act Effect Green (s)		10.3			10.3	75.3	65.0	65.0		107.7	111.7	
Actuated g/C Ratio		0.08			0.08	0.58	0.50	0.50		0.83	0.86	
v/c Ratio		0.30			0.18	0.69	0.08	1.03		0.48	0.49	
Control Delay		55.6			58.4	4.2	18.6	63.1		25.0	3.0	
Queue Delay		0.0			0.0	0.0	0.0	28.5		0.0	0.0	
Total Delay		55.6			58.4	4.2	18.6	91.7		25.0	3.0	
LOS		E			E	A	B	F		C	A	
Approach Delay		55.6			5.6			91.0			9.4	
Approach LOS		E			A			F			A	

Intersection Summary

Area Type: CBD
 Cycle Length: 130
 Actuated Cycle Length: 130
 Offset: 67 (52%), Referenced to phase 2:NESW, Start of Yellow
 Natural Cycle: 120
 Control Type: Actuated-Coordinated
 Maximum v/c Ratio: 1.03
 Intersection Signal Delay: 39.8
 Intersection LOS: D
 Intersection Capacity Utilization 116.0%
 ICU Level of Service H
 Analysis Period (min) 15
 * User Entered Value

Splits and Phases: 54: Alton Rd & N Michigan Ave

01	02 (R)	04
24 s	69 s	37 s

APPENDIX F

Peak Hour Calculations, Percent Heavy Vehicles and Lane Widths

Alton Road and Dade Boulevard

Peak Hour Time Period	Northbound		Southbound		Eastbound		Westbound	
	Volume	15-Min Max	Volume	15-Min Max	Volume	15-Min Max	Volume	15-Min Max
3:30 PM 3:45 PM	359	435	301	309	103	103	144	169
3:45 PM 4:00 PM	365	435	309	309	74	103	155	169
4:00 PM 4:15 PM	361	435	282	309	91	103	130	169
4:15 PM 4:30 PM	435	435	282	309	62	103	169	169
Total	1520	1740	1174	1236	330	412	598	676
	PHF =	0.87	PHF =	0.95	PHF =	0.80	PHF =	0.88

Alton Road and 19th Street

Peak Hour Time Period	Northbound		Southbound		Eastbound		Westbound	
	Volume	15-Min Max	Volume	15-Min Max	Volume	15-Min Max	Volume	15-Min Max
3:30 PM 3:45 PM	377	387	272	272		0	22	23
3:45 PM 4:00 PM	365	387	242	272		0	16	23
4:00 PM 4:15 PM	387	387	242	272		0	23	23
4:15 PM 4:30 PM	383	387	228	272		0	13	23
Total	1512	1548	984	1088	0	0	74	92
	PHF =	0.98	PHF =	0.90	PHF =	#DIV/0!	PHF =	0.80

Alton Road and Michigan Avenue

Peak Hour Time Period	Northbound		Southbound		Eastbound		Westbound	
	Volume	15-Min Max	Volume	15-Min Max	Volume	15-Min Max	Volume	15-Min Max
3:30 PM 3:45 PM	374	374	415	430	7	7	134	197
3:45 PM 4:00 PM	372	374	430	430	5	7	121	197
4:00 PM 4:15 PM	362	374	394	430	5	7	197	197
4:15 PM 4:30 PM	372	374	400	430	5	7	153	197
Total	1480	1496	1639	1720	22	28	605	788
	PHF =	0.99	PHF =	0.95	PHF =	0.79	PHF =	0.77

Dade Boulevard and Michigan Avenue

Peak Hour Time Period	Northbound		Southbound		Eastbound		Westbound	
	Volume	15-Min Max	Volume	15-Min Max	Volume	15-Min Max	Volume	15-Min Max
4:00 PM 4:15 PM	108	111	358	359	206	213	0	0
4:15 PM 4:30 PM	88	111	359	359	213	213	0	0
4:30 PM 4:45 PM	111	111	352	359	187	213	0	0
4:45 PM 5:00 PM	111	111	340	359	188	213	0	0
Total	418	444	1409	1436	794	852	0	0
	PHF =	0.94	PHF =	0.98	PHF =	0.93	PHF =	#DIV/0!

NOTE: For Dade and Michigan, the NB and SB were coded as EB and WB on SYNCHRO.

NOTE: Percentages in **black** derived from traffic counts. Percentages in **red** not available – estimated based on nearby truck percentages. All percentages rounded for SYNCHRO per rounding rule.



LEGEND

% Truck Traffic

Traf Tech
ENGINEERING, INC.

PERCENT HEAVY VEHICLES

FIGURE F-1
1901 Alton
Miami Beach, Florida

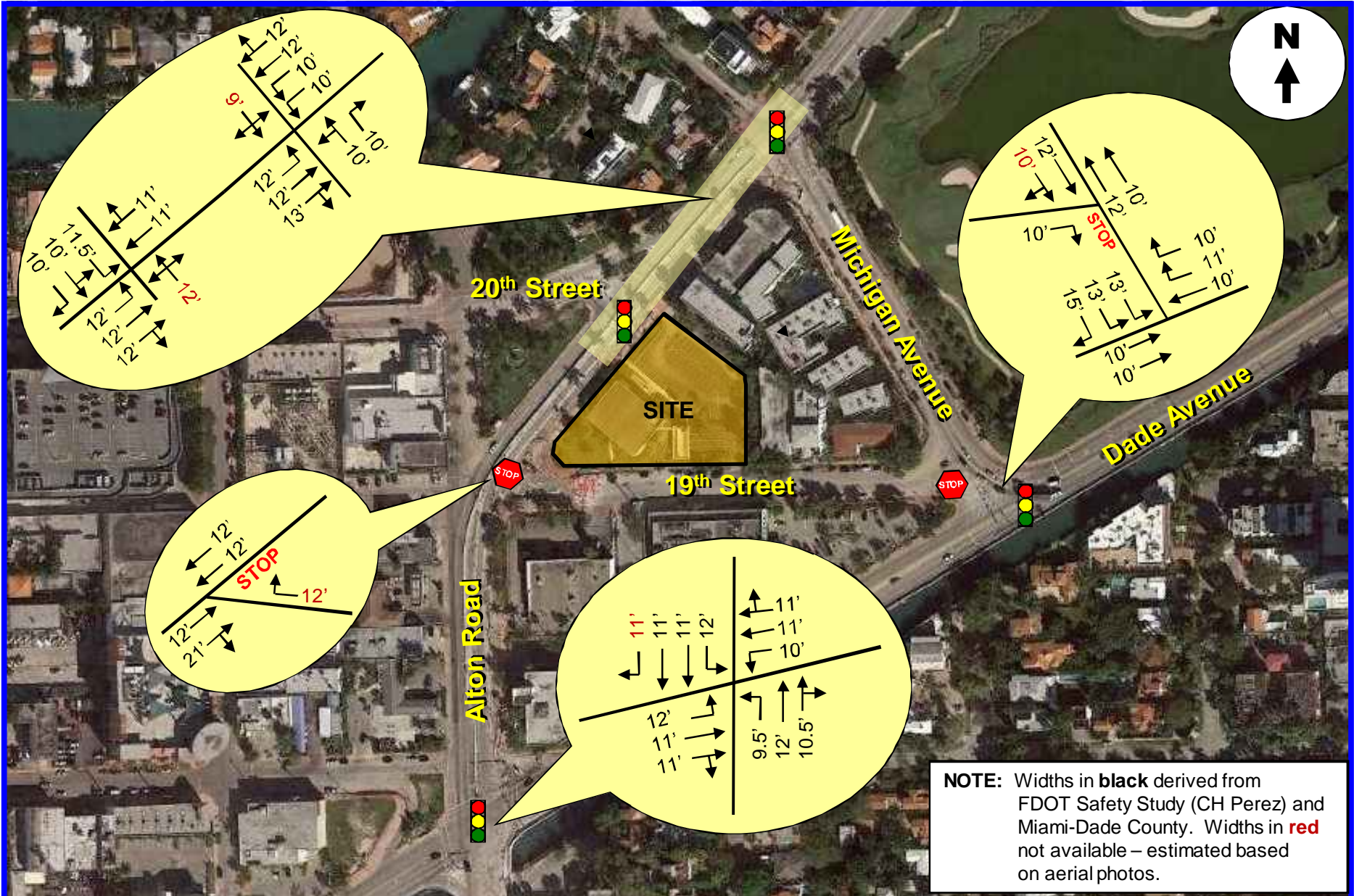

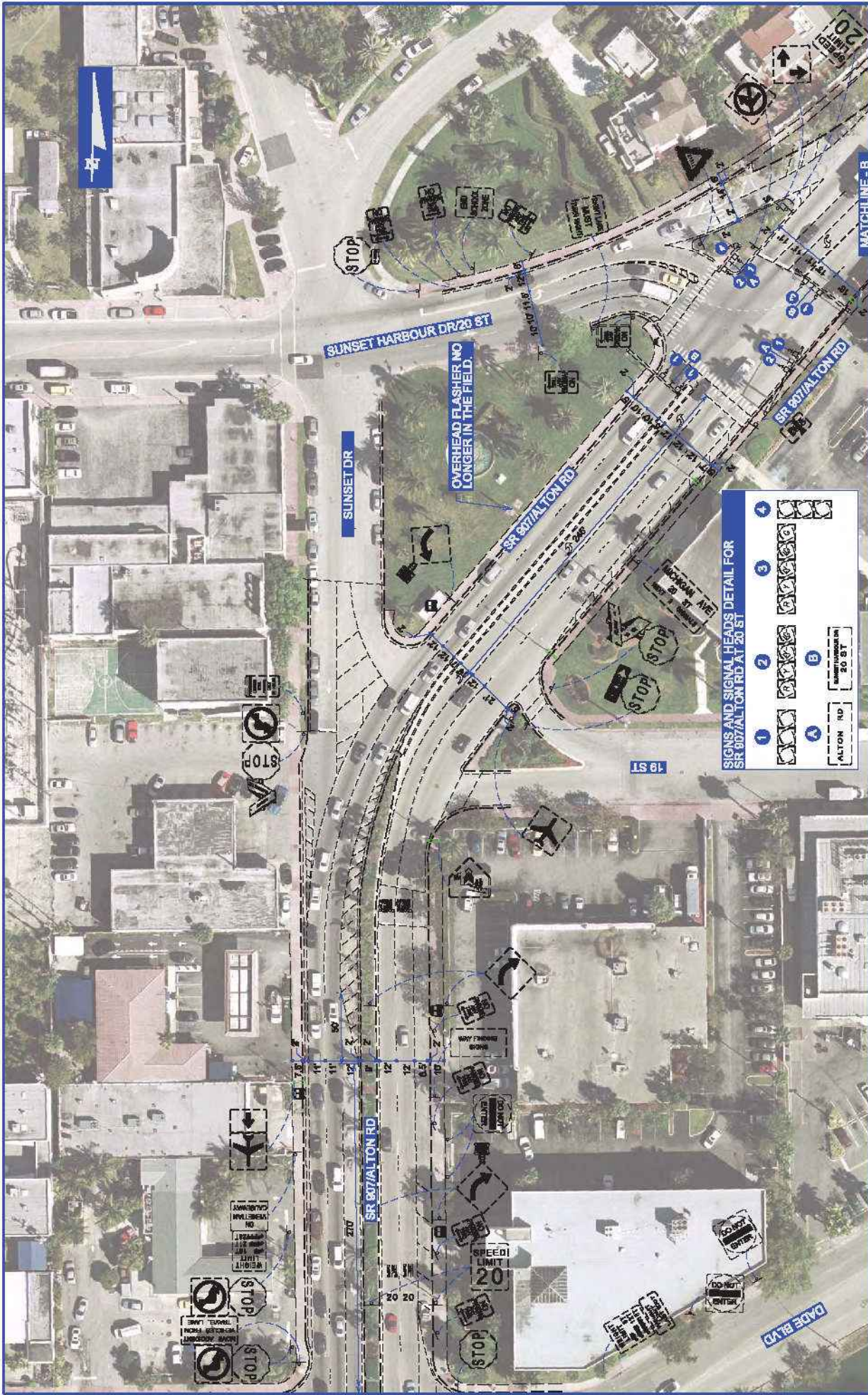

EXISTING CONDITION DIAGRAM
SR 907/ALTON RD FROM
DADE BLVD TO MICHIGAN AVE

FIGURE NO. **2-8**

LEGEND:

EXISTING SIGN PANEL	↑	DIRECTIONAL ARROW	→	RED SIGNAL	→
NEW SIGN PANEL	↑	NEW DIRECTIONAL ARROW	→	NEW SIGNAL	→
EXISTING STRUCTURE	□	NEW STRUCTURE	□	EXISTING HEAD	□
NEW STRUCTURE	□	EXISTING HEAD	□	NEW HEAD	□
MANHOLE	○	BUS STOP	○	EXISTING HEAD	□
				NEW HEAD	□

CHITREZ & ASSOCIATES CONSULTING ENGINEERS, INC.
 CERTIFICATE OF AUTHORIZATION NO. EB-20073
 1000 N.W. 107th Ave., Suite 201
 MIAMI, FL 33156 USA
 (305) 551-1077 FAX: (305) 551-1076
 6/27/2011

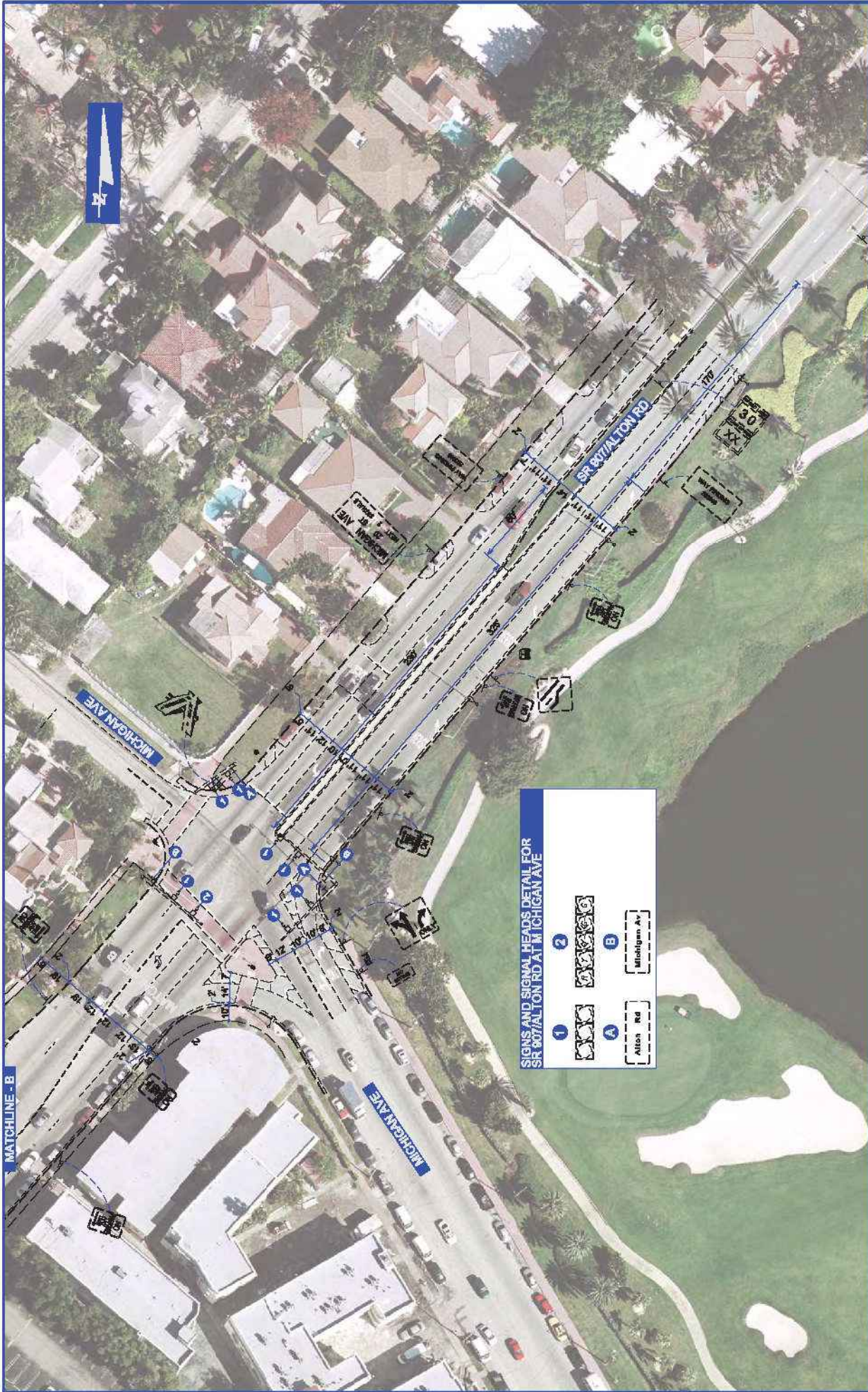

LEGEND: EXISTING SIGN PANEL PROPOSED SIGN PANEL EXISTING STRUCTURE PROPOSED STRUCTURE MANHOLE DIRECTIONAL ARROW LIGHT POLE BUS STOP		3-SECTION HEAD 2-SECTION HEAD 1-SECTION HEAD 4-SECTION HEAD	RED SIGNAL 1-SECTION HEAD 2-SECTION HEAD 3-SECTION HEAD 4-SECTION HEAD
--	--	--	--

SIGNS AND SIGNAL HEADS DETAIL FOR SR 907/ALTON RD AT MICHIGAN AVE

1

2

A

B

Alton Rd

Michigan Ave

CH PEREZ & ASSOCIATES CONSULTING ENGINEERS, INC.
 CERTIFICATE OF AUTHORIZATION NO. EB-20070
 10000 W. BIRDAWAY, SUITE 201
 MIAMI, FLORIDA 33156
 (305) 555-1077 FAX: (305) 555-1078



























4/27/2011

EXISTING CONDITION DIAGRAM
SR 907/ALTON RD FROM
DADE BLVD TO MICHIGAN AVE

FIGURE NO. **2-C**

Lanes, Volumes, Timings
10: Alton Road & Dade Boulevard

5/13/2015

												
Lane Group	EBL	EBT	EBR	WBL	WBT	WBR	NBL	NBT	NBR	SBL	SBT	SBR
Lane Configurations		 			 			 			 	
Volume (vph)	116	121	36	318	142	101	73	1292	192	72	1049	76
Ideal Flow (vphpl)	1900	1900	1900	1900	1900	1900	1900	1900	1900	1900	1900	1900
Lane Width (ft)	11	12	12	11	12	12	11	12	12	11	12	12
Storage Length (ft)	220		0	185		0	0		0	0		70
Storage Lanes	1		0	1		1	1		0	1		1
Taper Length (ft)	25			25			25			25		
Lane Util. Factor	1.00	0.95	0.95	1.00	0.95	1.00	1.00	0.95	0.95	1.00	0.95	1.00
Frt		0.966				0.850		0.981				0.850
Flt Protected	0.950			0.950			0.950			0.950		
Satd. Flow (prot)	1525	3047	0	1540	3185	1425	1540	2906	0	1540	3185	1425
Flt Permitted	0.650			0.614			0.950			0.950		
Satd. Flow (perm)	1043	3047	0	995	3185	1425	1540	2906	0	1540	3185	1425
Right Turn on Red			Yes			Yes			Yes			Yes
Satd. Flow (RTOR)		28				115		16				70
Link Speed (mph)		30			30			30			30	
Link Distance (ft)		774			969			240			314	
Travel Time (s)		17.6			22.0			5.5			7.1	
Peak Hour Factor	0.80	0.80	0.80	0.88	0.88	0.88	0.87	0.87	0.87	0.95	0.95	0.95
Heavy Vehicles (%)	3%	3%	3%	2%	2%	2%	2%	2%	2%	2%	2%	2%
Parking (#/hr)								8	8			
Adj. Flow (vph)	145	151	45	361	161	115	84	1485	221	76	1104	80
Shared Lane Traffic (%)												
Lane Group Flow (vph)	145	196	0	361	161	115	84	1706	0	76	1104	80
Enter Blocked Intersection	No	No	No	No	No	No	No	No	No	No	No	No
Lane Alignment	Left	Left	Right	Left	Left	Right	Left	Left	Right	Left	Left	Right
Median Width(ft)		11			11			11			11	
Link Offset(ft)		0			0			0			0	
Crosswalk Width(ft)		10			10			10			10	
Two way Left Turn Lane												
Headway Factor	1.19	1.14	1.14	1.19	1.14	1.14	1.19	1.25	1.14	1.19	1.14	1.14
Turning Speed (mph)	15		9	15		9	15		9	15		9
Number of Detectors	1	1		1	1	1	1	1		1	1	1
Detector Template	Left	Thru		Left	Thru	Right	Left	Thru		Left	Thru	Right
Leading Detector (ft)	24	24		24	24	24	24	24		24	24	24
Trailing Detector (ft)	-6	-6		-6	-6	-6	-6	-6		-6	-6	-6
Detector 1 Position(ft)	-6	-6		-6	-6	-6	-6	-6		-6	-6	-6
Detector 1 Size(ft)	30	30		30	30	30	30	30		30	30	30
Detector 1 Type	Cl+Ex	Cl+Ex		Cl+Ex	Cl+Ex	Cl+Ex	Cl+Ex	Cl+Ex		Cl+Ex	Cl+Ex	Cl+Ex
Detector 1 Channel												
Detector 1 Extend (s)	0.0	0.0		0.0	0.0	0.0	0.0	0.0		0.0	0.0	0.0
Detector 1 Queue (s)	0.0	0.0		0.0	0.0	0.0	0.0	0.0		0.0	0.0	0.0
Detector 1 Delay (s)	0.0	0.0		0.0	0.0	0.0	0.0	0.0		0.0	0.0	0.0
Turn Type	pm+pt	NA		pm+pt	NA	Perm	Prot	NA		Prot	NA	Perm
Protected Phases	3	8		7	4		1	6		5	2	
Permitted Phases	8			4		4						2
Detector Phase	3	8		7	4	4	1	6		5	2	2
Switch Phase												
Minimum Initial (s)	5.0	7.0		5.0	7.0	7.0	5.0	7.0		5.0	7.0	7.0

Lanes, Volumes, Timings
10: Alton Road & Dade Boulevard

5/13/2015



Lane Group	EBL	EBT	EBR	WBL	WBT	WBR	NBL	NBT	NBR	SBL	SBT	SBR
Minimum Split (s)	8.0	44.4		8.0	44.4	44.4	8.0	30.8		8.0	30.8	30.8
Total Split (s)	15.0	37.4		15.0	37.4	37.4	13.0	64.6		13.0	64.6	64.6
Total Split (%)	11.5%	28.8%		11.5%	28.8%	28.8%	10.0%	49.7%		10.0%	49.7%	49.7%
Maximum Green (s)	12.0	32.0		12.0	32.0	32.0	10.0	59.8		10.0	59.8	59.8
Yellow Time (s)	3.0	4.0		3.0	4.0	4.0	3.0	4.0		3.0	4.0	4.0
All-Red Time (s)	0.0	1.4		0.0	1.4	1.4	0.0	0.8		0.0	0.8	0.8
Lost Time Adjust (s)	2.5	2.5		2.5	2.5	2.5	2.5	2.5		2.5	2.5	2.5
Total Lost Time (s)	5.5	7.9		5.5	7.9	7.9	5.5	7.3		5.5	7.3	7.3
Lead/Lag	Lead	Lag		Lead	Lag	Lag	Lead	Lag		Lead	Lag	Lag
Lead-Lag Optimize?	Yes	Yes		Yes	Yes	Yes	Yes	Yes		Yes	Yes	Yes
Vehicle Extension (s)	2.0	2.5		2.0	2.0	2.0	2.0	1.0		2.0	1.0	1.0
Recall Mode	None	None		Max	None	None	None	C-Max		None	C-Max	C-Max
Walk Time (s)		7.0			7.0	7.0		7.0			7.0	7.0
Flash Dont Walk (s)		32.0			32.0	32.0		19.0			19.0	19.0
Pedestrian Calls (#/hr)		13			21	21		23			53	53
Act Effect Green (s)	31.9	20.5		32.9	21.0	21.0	7.5	66.7		7.1	66.3	66.3
Actuated g/C Ratio	0.25	0.16		0.25	0.16	0.16	0.06	0.51		0.05	0.51	0.51
v/c Ratio	0.50	0.39		1.24	0.31	0.35	0.95	1.14		0.92	0.68	0.11
Control Delay	41.0	41.9		171.7	47.5	10.2	144.7	101.4		136.9	28.7	6.4
Queue Delay	0.0	0.0		0.0	0.0	0.0	0.0	0.0		0.0	0.0	0.0
Total Delay	41.0	41.9		171.7	47.5	10.2	144.7	101.4		136.9	28.7	6.4
LOS	D	D		F	D	B	F	F		F	C	A
Approach Delay		41.5			111.1			103.4			33.8	
Approach LOS		D			F			F			C	

Intersection Summary

Area Type: CBD

Cycle Length: 130

Actuated Cycle Length: 130

Offset: 65 (50%), Referenced to phase 2:SBT and 6:NBT, Start of Green

Natural Cycle: 145

Control Type: Actuated-Coordinated

Maximum v/c Ratio: 1.24

Intersection Signal Delay: 77.6

Intersection LOS: E

Intersection Capacity Utilization 98.2%

ICU Level of Service F

Analysis Period (min) 15

Splits and Phases: 10: Alton Road & Dade Boulevard

ø1	ø2 (R)	ø3	ø4
13 s	64.6 s	15 s	37.4 s
ø5	ø6 (R)	ø7	ø8
13 s	64.6 s	15 s	37.4 s

Queues

10: Alton Road & Dade Boulevard

5/13/2015



Lane Group	EBL	EBT	WBL	WBT	WBR	NBL	NBT	SBL	SBT	SBR
Lane Group Flow (vph)	145	196	361	161	115	84	1706	76	1104	80
v/c Ratio	0.50	0.39	1.24	0.31	0.35	0.95	1.14	0.92	0.68	0.11
Control Delay	41.0	41.9	171.7	47.5	10.2	144.7	101.4	136.9	28.7	6.4
Queue Delay	0.0	0.0	0.0	0.0	0.0	0.0	0.0	0.0	0.0	0.0
Total Delay	41.0	41.9	171.7	47.5	10.2	144.7	101.4	136.9	28.7	6.4
Queue Length 50th (ft)	86	61	~257	58	0	72	~979	65	412	5
Queue Length 95th (ft)	123	84	#481	88	47	#171	#1063	#160	504	35
Internal Link Dist (ft)		694		889			160		234	
Turn Bay Length (ft)	220		185							70
Base Capacity (vph)	295	713	291	722	412	88	1499	88	1624	761
Starvation Cap Reductn	0	0	0	0	0	0	0	0	0	0
Spillback Cap Reductn	0	0	0	0	0	0	0	0	0	0
Storage Cap Reductn	0	0	0	0	0	0	0	0	0	0
Reduced v/c Ratio	0.49	0.27	1.24	0.22	0.28	0.95	1.14	0.86	0.68	0.11

Intersection Summary

~ Volume exceeds capacity, queue is theoretically infinite.























Queue shown is maximum after two cycles.

95th percentile volume exceeds capacity, queue may be longer.

Queue shown is maximum after two cycles.

Lanes, Volumes, Timings
10: Alton Road & Dade Boulevard

5/13/2015

												
Lane Group	EBL	EBT	EBR	WBL	WBT	WBR	NBL	NBT	NBR	SBL	SBT	SBR
Lane Configurations												
Volume (vph)	119	123	37	325	145	103	75	1318	195	74	1070	78
Ideal Flow (vphpl)	1900	1900	1900	1900	1900	1900	1900	1900	1900	1900	1900	1900
Lane Width (ft)	11	12	12	11	12	12	11	12	12	11	12	12
Storage Length (ft)	220		0	185		0	0		0	0		70
Storage Lanes	1		0	1		1	1		0	1		1
Taper Length (ft)	25			25			25			25		
Lane Util. Factor	1.00	0.95	0.95	1.00	0.95	1.00	1.00	0.95	0.95	1.00	0.95	1.00
Frt		0.965				0.850		0.981				0.850
Flt Protected	0.950			0.950			0.950			0.950		
Satd. Flow (prot)	1525	3044	0	1540	3185	1425	1540	2906	0	1540	3185	1425
Flt Permitted	0.648			0.611			0.950			0.950		
Satd. Flow (perm)	1040	3044	0	990	3185	1425	1540	2906	0	1540	3185	1425
Right Turn on Red			Yes			Yes			Yes			Yes
Satd. Flow (RTOR)		28				117		16				70
Link Speed (mph)		30			30			30			30	
Link Distance (ft)		774			969			240			314	
Travel Time (s)		17.6			22.0			5.5			7.1	
Peak Hour Factor	0.80	0.80	0.80	0.88	0.88	0.88	0.87	0.87	0.87	0.95	0.95	0.95
Heavy Vehicles (%)	3%	3%	3%	2%	2%	2%	2%	2%	2%	2%	2%	2%
Parking (#/hr)								8	8			
Adj. Flow (vph)	149	154	46	369	165	117	86	1515	224	78	1126	82
Shared Lane Traffic (%)												
Lane Group Flow (vph)	149	200	0	369	165	117	86	1739	0	78	1126	82
Enter Blocked Intersection	No	No	No	No	No	No	No	No	No	No	No	No
Lane Alignment	Left	Left	Right	Left	Left	Right	Left	Left	Right	Left	Left	Right
Median Width(ft)		11			11			11			11	
Link Offset(ft)		0			0			0			0	
Crosswalk Width(ft)		10			10			10			10	
Two way Left Turn Lane												
Headway Factor	1.19	1.14	1.14	1.19	1.14	1.14	1.19	1.25	1.14	1.19	1.14	1.14
Turning Speed (mph)	15		9	15		9	15		9	15		9
Number of Detectors	1	1		1	1	1	1	1		1	1	1
Detector Template	Left	Thru		Left	Thru	Right	Left	Thru		Left	Thru	Right
Leading Detector (ft)	24	24		24	24	24	24	24		24	24	24
Trailing Detector (ft)	-6	-6		-6	-6	-6	-6	-6		-6	-6	-6
Detector 1 Position(ft)	-6	-6		-6	-6	-6	-6	-6		-6	-6	-6
Detector 1 Size(ft)	30	30		30	30	30	30	30		30	30	30
Detector 1 Type	Cl+Ex	Cl+Ex		Cl+Ex	Cl+Ex	Cl+Ex	Cl+Ex	Cl+Ex		Cl+Ex	Cl+Ex	Cl+Ex
Detector 1 Channel												
Detector 1 Extend (s)	0.0	0.0		0.0	0.0	0.0	0.0	0.0		0.0	0.0	0.0
Detector 1 Queue (s)	0.0	0.0		0.0	0.0	0.0	0.0	0.0		0.0	0.0	0.0
Detector 1 Delay (s)	0.0	0.0		0.0	0.0	0.0	0.0	0.0		0.0	0.0	0.0
Turn Type	pm+pt	NA		pm+pt	NA	Perm	Prot	NA		Prot	NA	Perm
Protected Phases	3	8		7	4		1	6		5	2	
Permitted Phases	8			4		4						2
Detector Phase	3	8		7	4	4	1	6		5	2	2
Switch Phase												
Minimum Initial (s)	5.0	7.0		5.0	7.0	7.0	5.0	7.0		5.0	7.0	7.0

Lanes, Volumes, Timings
10: Alton Road & Dade Boulevard

5/13/2015



Lane Group	EBL	EBT	EBR	WBL	WBT	WBR	NBL	NBT	NBR	SBL	SBT	SBR
Minimum Split (s)	8.0	44.4		8.0	44.4	44.4	8.0	30.8		8.0	30.8	30.8
Total Split (s)	15.0	37.4		15.0	37.4	37.4	13.0	64.6		13.0	64.6	64.6
Total Split (%)	11.5%	28.8%		11.5%	28.8%	28.8%	10.0%	49.7%		10.0%	49.7%	49.7%
Maximum Green (s)	12.0	32.0		12.0	32.0	32.0	10.0	59.8		10.0	59.8	59.8
Yellow Time (s)	3.0	4.0		3.0	4.0	4.0	3.0	4.0		3.0	4.0	4.0
All-Red Time (s)	0.0	1.4		0.0	1.4	1.4	0.0	0.8		0.0	0.8	0.8
Lost Time Adjust (s)	2.5	2.5		2.5	2.5	2.5	2.5	2.5		2.5	2.5	2.5
Total Lost Time (s)	5.5	7.9		5.5	7.9	7.9	5.5	7.3		5.5	7.3	7.3
Lead/Lag	Lead	Lag		Lead	Lag	Lag	Lead	Lag		Lead	Lag	Lag
Lead-Lag Optimize?	Yes	Yes		Yes	Yes	Yes	Yes	Yes		Yes	Yes	Yes
Vehicle Extension (s)	2.0	2.5		2.0	2.0	2.0	2.0	1.0		2.0	1.0	1.0
Recall Mode	None	None		Max	None	None	None	C-Max		None	C-Max	C-Max
Walk Time (s)		7.0			7.0	7.0		7.0			7.0	7.0
Flash Dont Walk (s)		32.0			32.0	32.0		19.0			19.0	19.0
Pedestrian Calls (#/hr)		13			21	21		23			53	53
Act Effect Green (s)	32.0	20.5		32.9	21.0	21.0	7.5	66.6		7.2	66.3	66.3
Actuated g/C Ratio	0.25	0.16		0.25	0.16	0.16	0.06	0.51		0.06	0.51	0.51
v/c Ratio	0.52	0.40		1.27	0.32	0.36	0.98	1.16		0.93	0.69	0.11
Control Delay	41.5	42.2		182.7	47.6	10.2	150.5	111.2		139.9	29.2	6.6
Queue Delay	0.0	0.0		0.0	0.0	0.0	0.0	0.0		0.0	0.0	0.0
Total Delay	41.5	42.2		182.7	47.6	10.2	150.5	111.2		139.9	29.2	6.6
LOS	D	D		F	D	B	F	F		F	C	A
Approach Delay		41.9			117.5			113.1			34.5	
Approach LOS		D			F			F			C	

Intersection Summary

Area Type: CBD

Cycle Length: 130

Actuated Cycle Length: 130

Offset: 65 (50%), Referenced to phase 2:SBT and 6:NBT, Start of Green

Natural Cycle: 145

Control Type: Actuated-Coordinated

Maximum v/c Ratio: 1.27

Intersection Signal Delay: 83.1

Intersection LOS: F

Intersection Capacity Utilization 99.6%

ICU Level of Service F

Analysis Period (min) 15

Splits and Phases: 10: Alton Road & Dade Boulevard

ø1	ø2 (R)	ø3	ø4
13 s	64.6 s	15 s	37.4 s
ø5	ø6 (R)	ø7	ø8
13 s	64.6 s	15 s	37.4 s

Queues

10: Alton Road & Dade Boulevard

5/13/2015

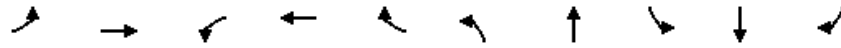



























Lane Group	EBL	EBT	WBL	WBT	WBR	NBL	NBT	SBL	SBT	SBR
Lane Group Flow (vph)	149	200	369	165	117	86	1739	78	1126	82
v/c Ratio	0.52	0.40	1.27	0.32	0.36	0.98	1.16	0.93	0.69	0.11
Control Delay	41.5	42.2	182.7	47.6	10.2	150.5	111.2	139.9	29.2	6.6
Queue Delay	0.0	0.0	0.0	0.0	0.0	0.0	0.0	0.0	0.0	0.0
Total Delay	41.5	42.2	182.7	47.6	10.2	150.5	111.2	139.9	29.2	6.6
Queue Length 50th (ft)	88	63	~275	60	0	74	~1010	67	424	6
Queue Length 95th (ft)	126	86	#513	91	48	#174	#1092	#166	517	36
Internal Link Dist (ft)		694		889			160		234	
Turn Bay Length (ft)	220		185							70
Base Capacity (vph)	294	712	291	722	413	88	1496	88	1623	760
Starvation Cap Reductn	0	0	0	0	0	0	0	0	0	0
Spillback Cap Reductn	0	0	0	0	0	0	0	0	0	0
Storage Cap Reductn	0	0	0	0	0	0	0	0	0	0
Reduced v/c Ratio	0.51	0.28	1.27	0.23	0.28	0.98	1.16	0.89	0.69	0.11

Intersection Summary

- ~ Volume exceeds capacity, queue is theoretically infinite.
Queue shown is maximum after two cycles.
- # 95th percentile volume exceeds capacity, queue may be longer.
Queue shown is maximum after two cycles.

Lanes, Volumes, Timings
10: Alton Road & Dade Boulevard

5/13/2015

												
Lane Group	EBL	EBT	EBR	WBL	WBT	WBR	NBL	NBT	NBR	SBL	SBT	SBR
Lane Configurations		 			 			 			 	
Volume (vph)	177	123	37	409	201	161	75	1405	195	74	1070	78
Ideal Flow (vphpl)	1900	1900	1900	1900	1900	1900	1900	1900	1900	1900	1900	1900
Lane Width (ft)	11	12	12	11	12	12	11	12	12	11	12	12
Storage Length (ft)	220		0	185		0	0		0	0		70
Storage Lanes	1		0	1		1	1		0	1		1
Taper Length (ft)	25			25			25			25		
Lane Util. Factor	1.00	0.95	0.95	1.00	0.95	1.00	1.00	0.95	0.95	1.00	0.95	1.00
Frt		0.965				0.850		0.982				0.850
Flt Protected	0.950			0.950			0.950			0.950		
Satd. Flow (prot)	1525	3044	0	1540	3185	1425	1540	2909	0	1540	3185	1425
Flt Permitted	0.610			0.626			0.950			0.950		
Satd. Flow (perm)	979	3044	0	1014	3185	1425	1540	2909	0	1540	3185	1425
Right Turn on Red			Yes			Yes			Yes			Yes
Satd. Flow (RTOR)		28				183		15				70
Link Speed (mph)		30			30			30			30	
Link Distance (ft)		774			969			240			314	
Travel Time (s)		17.6			22.0			5.5			7.1	
Peak Hour Factor	0.80	0.80	0.80	0.88	0.88	0.88	0.87	0.87	0.87	0.95	0.95	0.95
Heavy Vehicles (%)	3%	3%	3%	2%	2%	2%	2%	2%	2%	2%	2%	2%
Parking (#/hr)								8	8			
Adj. Flow (vph)	221	154	46	465	228	183	86	1615	224	78	1126	82
Shared Lane Traffic (%)												
Lane Group Flow (vph)	221	200	0	465	228	183	86	1839	0	78	1126	82
Enter Blocked Intersection	No	No	No	No	No	No	No	No	No	No	No	No
Lane Alignment	Left	Left	Right	Left	Left	Right	Left	Left	Right	Left	Left	Right
Median Width(ft)		11			11			11			11	
Link Offset(ft)		0			0			0			0	
Crosswalk Width(ft)		10			10			10			10	
Two way Left Turn Lane												
Headway Factor	1.19	1.14	1.14	1.19	1.14	1.14	1.19	1.25	1.14	1.19	1.14	1.14
Turning Speed (mph)	15		9	15		9	15		9	15		9
Number of Detectors	1	1		1	1	1	1	1		1	1	1
Detector Template	Left	Thru		Left	Thru	Right	Left	Thru		Left	Thru	Right
Leading Detector (ft)	24	24		24	24	24	24	24		24	24	24
Trailing Detector (ft)	-6	-6		-6	-6	-6	-6	-6		-6	-6	-6
Detector 1 Position(ft)	-6	-6		-6	-6	-6	-6	-6		-6	-6	-6
Detector 1 Size(ft)	30	30		30	30	30	30	30		30	30	30
Detector 1 Type	Cl+Ex	Cl+Ex		Cl+Ex	Cl+Ex	Cl+Ex	Cl+Ex	Cl+Ex		Cl+Ex	Cl+Ex	Cl+Ex
Detector 1 Channel												
Detector 1 Extend (s)	0.0	0.0		0.0	0.0	0.0	0.0	0.0		0.0	0.0	0.0
Detector 1 Queue (s)	0.0	0.0		0.0	0.0	0.0	0.0	0.0		0.0	0.0	0.0
Detector 1 Delay (s)	0.0	0.0		0.0	0.0	0.0	0.0	0.0		0.0	0.0	0.0
Turn Type	pm+pt	NA		pm+pt	NA	Perm	Prot	NA		Prot	NA	Perm
Protected Phases	3	8		7	4		1	6		5	2	
Permitted Phases	8			4		4						2
Detector Phase	3	8		7	4	4	1	6		5	2	2
Switch Phase												
Minimum Initial (s)	5.0	7.0		5.0	7.0	7.0	5.0	7.0		5.0	7.0	7.0

Lanes, Volumes, Timings
 10: Alton Road & Dade Boulevard

5/13/2015



Lane Group	EBL	EBT	EBR	WBL	WBT	WBR	NBL	NBT	NBR	SBL	SBT	SBR
Minimum Split (s)	8.0	44.4		8.0	44.4	44.4	8.0	30.8		8.0	30.8	30.8
Total Split (s)	15.0	37.4		15.0	37.4	37.4	13.0	64.6		13.0	64.6	64.6
Total Split (%)	11.5%	28.8%		11.5%	28.8%	28.8%	10.0%	49.7%		10.0%	49.7%	49.7%
Maximum Green (s)	12.0	32.0		12.0	32.0	32.0	10.0	59.8		10.0	59.8	59.8
Yellow Time (s)	3.0	4.0		3.0	4.0	4.0	3.0	4.0		3.0	4.0	4.0
All-Red Time (s)	0.0	1.4		0.0	1.4	1.4	0.0	0.8		0.0	0.8	0.8
Lost Time Adjust (s)	2.5	2.5		2.5	2.5	2.5	2.5	2.5		2.5	2.5	2.5
Total Lost Time (s)	5.5	7.9		5.5	7.9	7.9	5.5	7.3		5.5	7.3	7.3
Lead/Lag	Lead	Lag		Lead	Lag	Lag	Lead	Lag		Lead	Lag	Lag
Lead-Lag Optimize?	Yes	Yes		Yes	Yes	Yes	Yes	Yes		Yes	Yes	Yes
Vehicle Extension (s)	2.0	2.5		2.0	2.0	2.0	2.0	1.0		2.0	1.0	1.0
Recall Mode	None	None		Max	None	None	None	C-Max		None	C-Max	C-Max
Walk Time (s)		7.0			7.0	7.0		7.0			7.0	7.0
Flash Dont Walk (s)		32.0			32.0	32.0		19.0			19.0	19.0
Pedestrian Calls (#/hr)		13			21	21		23			53	53
Act Effect Green (s)	33.0	21.1		33.0	21.1	21.1	7.5	66.0		7.2	65.7	65.7
Actuated g/C Ratio	0.25	0.16		0.25	0.16	0.16	0.06	0.51		0.06	0.51	0.51
v/c Ratio	0.77	0.39		1.58	0.44	0.48	0.98	1.24		0.93	0.70	0.11
Control Delay	56.9	41.8		306.0	50.0	10.0	150.5	143.0		139.9	29.5	6.6
Queue Delay	0.0	0.0		0.0	0.0	0.0	0.0	0.0		0.0	0.0	0.0
Total Delay	56.9	41.8		306.0	50.0	10.0	150.5	143.0		139.9	29.5	6.6
LOS	E	D		F	D	A	F	F		F	C	A
Approach Delay		49.7			177.5			143.3			34.8	
Approach LOS		D			F			F			C	

Intersection Summary

Area Type:	CBD
Cycle Length:	130
Actuated Cycle Length:	130
Offset:	65 (50%), Referenced to phase 2:SBT and 6:NBT, Start of Green
Natural Cycle:	145
Control Type:	Actuated-Coordinated
Maximum v/c Ratio:	1.58
Intersection Signal Delay:	110.3
Intersection Capacity Utilization	107.5%
Analysis Period (min)	15
Intersection LOS:	F
ICU Level of Service	G

Splits and Phases: 10: Alton Road & Dade Boulevard

ø1	ø2 (R)	ø3	ø4
13 s	64.6 s	15 s	37.4 s
ø5	ø6 (R)	ø7	ø8
13 s	64.6 s	15 s	37.4 s

Queues

10: Alton Road & Dade Boulevard

5/13/2015

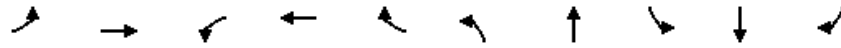

Lane Group	EBL	EBT	WBL	WBT	WBR	NBL	NBT	SBL	SBT	SBR
Lane Group Flow (vph)	221	200	465	228	183	86	1839	78	1126	82
v/c Ratio	0.77	0.39	1.58	0.44	0.48	0.98	1.24	0.93	0.70	0.11
Control Delay	56.9	41.8	306.0	50.0	10.0	150.5	143.0	139.9	29.5	6.6
Queue Delay	0.0	0.0	0.0	0.0	0.0	0.0	0.0	0.0	0.0	0.0
Total Delay	56.9	41.8	306.0	50.0	10.0	150.5	143.0	139.9	29.5	6.6
Queue Length 50th (ft)	138	63	~483	84	0	74	~1103	67	424	6
Queue Length 95th (ft)	184	86	#689	121	56	#174	#1182	#166	517	36
Internal Link Dist (ft)		694		889			160		234	
Turn Bay Length (ft)	220		185							70
Base Capacity (vph)	288	712	295	722	464	88	1485	88	1609	755
Starvation Cap Reductn	0	0	0	0	0	0	0	0	0	0
Spillback Cap Reductn	0	0	0	0	0	0	0	0	0	0
Storage Cap Reductn	0	0	0	0	0	0	0	0	0	0
Reduced v/c Ratio	0.77	0.28	1.58	0.32	0.39	0.98	1.24	0.89	0.70	0.11

Intersection Summary

~ Volume exceeds capacity, queue is theoretically infinite.























Queue shown is maximum after two cycles.

95th percentile volume exceeds capacity, queue may be longer.

Queue shown is maximum after two cycles.

Lanes, Volumes, Timings
10: Alton Road & Dade Boulevard

5/13/2015

												
Lane Group	EBL	EBT	EBR	WBL	WBT	WBR	NBL	NBT	NBR	SBL	SBT	SBR
Lane Configurations												
Volume (vph)	177	123	37	409	201	161	75	1405	195	74	1070	78
Ideal Flow (vphpl)	1900	1900	1900	1900	1900	1900	1900	1900	1900	1900	1900	1900
Lane Width (ft)	11	12	12	11	12	12	11	12	12	11	12	12
Storage Length (ft)	220		0	185		0	0		0	0		70
Storage Lanes	1		0	1		1	1		0	1		1
Taper Length (ft)	25			25			25			25		
Lane Util. Factor	1.00	0.95	0.95	1.00	0.95	1.00	1.00	0.95	0.95	1.00	0.95	1.00
Frt		0.965				0.850		0.982				0.850
Flt Protected	0.950			0.950			0.950			0.950		
Satd. Flow (prot)	1525	3044	0	1540	3185	1425	1540	2909	0	1540	3185	1425
Flt Permitted	0.610			0.602			0.950			0.950		
Satd. Flow (perm)	979	3044	0	976	3185	1425	1540	2909	0	1540	3185	1425
Right Turn on Red			Yes			Yes			Yes			Yes
Satd. Flow (RTOR)		30				142		15				70
Link Speed (mph)		30			30			30			30	
Link Distance (ft)		774			969			240			314	
Travel Time (s)		17.6			22.0			5.5			7.1	
Peak Hour Factor	0.80	0.80	0.80	0.88	0.88	0.88	0.87	0.87	0.87	0.95	0.95	0.95
Heavy Vehicles (%)	3%	3%	3%	2%	2%	2%	2%	2%	2%	2%	2%	2%
Parking (#/hr)								8	8			
Adj. Flow (vph)	221	154	46	465	228	183	86	1615	224	78	1126	82
Shared Lane Traffic (%)												
Lane Group Flow (vph)	221	200	0	465	228	183	86	1839	0	78	1126	82
Enter Blocked Intersection	No	No	No	No	No	No	No	No	No	No	No	No
Lane Alignment	Left	Left	Right	Left	Left	Right	Left	Left	Right	Left	Left	Right
Median Width(ft)		11			11			11			11	
Link Offset(ft)		0			0			0			0	
Crosswalk Width(ft)		10			10			10			10	
Two way Left Turn Lane												
Headway Factor	1.19	1.14	1.14	1.19	1.14	1.14	1.19	1.25	1.14	1.19	1.14	1.14
Turning Speed (mph)	15		9	15		9	15		9	15		9
Number of Detectors	1	1		1	1	1	1	1		1	1	1
Detector Template	Left	Thru		Left	Thru	Right	Left	Thru		Left	Thru	Right
Leading Detector (ft)	24	24		24	24	24	24	24		24	24	24
Trailing Detector (ft)	-6	-6		-6	-6	-6	-6	-6		-6	-6	-6
Detector 1 Position(ft)	-6	-6		-6	-6	-6	-6	-6		-6	-6	-6
Detector 1 Size(ft)	30	30		30	30	30	30	30		30	30	30
Detector 1 Type	Cl+Ex	Cl+Ex		Cl+Ex	Cl+Ex	Cl+Ex	Cl+Ex	Cl+Ex		Cl+Ex	Cl+Ex	Cl+Ex
Detector 1 Channel												
Detector 1 Extend (s)	0.0	0.0		0.0	0.0	0.0	0.0	0.0		0.0	0.0	0.0
Detector 1 Queue (s)	0.0	0.0		0.0	0.0	0.0	0.0	0.0		0.0	0.0	0.0
Detector 1 Delay (s)	0.0	0.0		0.0	0.0	0.0	0.0	0.0		0.0	0.0	0.0
Turn Type	pm+pt	NA		pm+pt	NA	Perm	Prot	NA		Prot	NA	Perm
Protected Phases	3	8		7	4		1	6		5	2	
Permitted Phases	8			4		4						2
Detector Phase	3	8		7	4	4	1	6		5	2	2
Switch Phase												
Minimum Initial (s)	5.0	7.0		5.0	7.0	7.0	5.0	7.0		5.0	7.0	7.0

Lanes, Volumes, Timings
 10: Alton Road & Dade Boulevard

5/13/2015

Lane Group	EBL	EBT	EBR	WBL	WBT	WBR	NBL	NBT	NBR	SBL	SBT	SBR
Minimum Split (s)	8.0	44.4		8.0	44.4	44.4	8.0	30.8		8.0	30.8	30.8
Total Split (s)	10.0	44.4		11.0	45.4	45.4	12.0	64.6		10.0	62.6	62.6
Total Split (%)	7.7%	34.2%		8.5%	34.9%	34.9%	9.2%	49.7%		7.7%	48.2%	48.2%
Maximum Green (s)	7.0	39.0		8.0	40.0	40.0	9.0	59.8		7.0	57.8	57.8
Yellow Time (s)	3.0	4.0		3.0	4.0	4.0	3.0	4.0		3.0	4.0	4.0
All-Red Time (s)	0.0	1.4		0.0	1.4	1.4	0.0	0.8		0.0	0.8	0.8
Lost Time Adjust (s)	2.5	2.5		2.5	2.5	2.5	2.5	2.5		2.5	2.5	2.5
Total Lost Time (s)	5.5	7.9		5.5	7.9	7.9	5.5	7.3		5.5	7.3	7.3
Lead/Lag	Lead	Lag		Lead	Lag	Lag	Lead	Lag		Lead	Lag	Lag
Lead-Lag Optimize?	Yes	Yes		Yes	Yes	Yes	Yes	Yes		Yes	Yes	Yes
Vehicle Extension (s)	2.0	2.5		2.0	2.0	2.0	2.0	1.0		2.0	1.0	1.0
Recall Mode	None	None		Max	None	None	None	C-Max		None	C-Max	C-Max
Walk Time (s)		7.0			7.0	7.0		7.0			7.0	7.0
Flash Dont Walk (s)		32.0			32.0	32.0		19.0			19.0	19.0
Pedestrian Calls (#/hr)		13			21	21		23			53	53
Act Effect Green (s)	31.6	24.7		33.6	25.7	25.7	6.5	69.1		4.5	67.1	67.1
Actuated g/C Ratio	0.24	0.19		0.26	0.20	0.20	0.05	0.53		0.03	0.52	0.52
v/c Ratio	0.86	0.33		1.69	0.36	0.46	1.12	1.18		1.47	0.69	0.11
Control Delay	71.7	37.2		354.7	44.3	13.9	192.5	118.9		331.7	29.3	6.9
Queue Delay	0.0	0.0		0.0	0.0	0.0	0.0	0.0		0.0	0.0	0.0
Total Delay	71.7	37.2		354.7	44.3	13.9	192.5	118.9		331.7	29.3	6.9
LOS	E	D		F	D	B	F	F		F	C	A
Approach Delay		55.3			202.7			122.2			46.2	
Approach LOS		E			F			F			D	

Intersection Summary

Area Type: CBD
 Cycle Length: 130
 Actuated Cycle Length: 130
 Offset: 65 (50%), Referenced to phase 2:SBT and 6:NBT, Start of Green
 Natural Cycle: 145
 Control Type: Actuated-Coordinated
 Maximum v/c Ratio: 1.69
 Intersection Signal Delay: 109.9
 Intersection Capacity Utilization 107.5%
 Analysis Period (min) 15
 Intersection LOS: F
 ICU Level of Service G

Splits and Phases: 10: Alton Road & Dade Boulevard

φ1	φ2 (R)	φ3	φ4
12 s	62.6 s	10 s	45.4 s
φ5	φ6 (R)	φ7	φ8
10 s	64.6 s	11 s	44.4 s

Queues

10: Alton Road & Dade Boulevard

5/13/2015



Lane Group	EBL	EBT	WBL	WBT	WBR	NBL	NBT	SBL	SBT	SBR
Lane Group Flow (vph)	221	200	465	228	183	86	1839	78	1126	82
v/c Ratio	0.86	0.33	1.69	0.36	0.46	1.12	1.18	1.47	0.69	0.11
Control Delay	71.7	37.2	354.7	44.3	13.9	192.5	118.9	331.7	29.3	6.9
Queue Delay	0.0	0.0	0.0	0.0	0.0	0.0	0.0	0.0	0.0	0.0
Total Delay	71.7	37.2	354.7	44.3	13.9	192.5	118.9	331.7	29.3	6.9
Queue Length 50th (ft)	135	58	~477	78	26	~83	~1093	~90	431	6
Queue Length 95th (ft)	177	78	#686	111	83	#185	#1182	#197	533	37
Internal Link Dist (ft)		694		889			160		234	
Turn Bay Length (ft)	220		185							70
Base Capacity (vph)	256	876	275	918	512	77	1553	53	1643	769
Starvation Cap Reductn	0	0	0	0	0	0	0	0	0	0
Spillback Cap Reductn	0	0	0	0	0	0	0	0	0	0
Storage Cap Reductn	0	0	0	0	0	0	0	0	0	0
Reduced v/c Ratio	0.86	0.23	1.69	0.25	0.36	1.12	1.18	1.47	0.69	0.11

Intersection Summary

- ~ Volume exceeds capacity, queue is theoretically infinite.
Queue shown is maximum after two cycles.
- # 95th percentile volume exceeds capacity, queue may be longer.
Queue shown is maximum after two cycles.

Lanes, Volumes, Timings
54: Alton Rd & N Michigan Ave

5/13/2015

Lane Group	SEL	SET	SER	NWL	NWT	NWR	NEL	NET	NER	SWL	SWT	SWR
Lane Configurations		↕			↕	↕	↕	↕↔		↕	↕↔	
Volume (vph)	6	4	4	12	3	609	0	1468	55	444	1236	7
Ideal Flow (vphpl)	1900	1900	1900	1900	1900	1900	1900	1900	1900	1900	1900	1900
Storage Length (ft)	0		0	0		0	100		0	215		0
Storage Lanes	0		0	0		1	1		0	1		0
Taper Length (ft)	25			25			25			25		
Lane Util. Factor	1.00	1.00	1.00	1.00	1.00	1.00	1.00	0.95	0.95	1.00	0.95	0.95
Ped Bike Factor		0.99						1.00				
Frt		0.962				0.850		0.995			0.999	
Flt Protected		0.978			0.962					0.950		
Satd. Flow (prot)	0	1551	0	0	1629	1439	1676	3168	0	1593	3182	0
Flt Permitted										0.056		
Satd. Flow (perm)	0	1585	0	0	1693	1439	1676	3168	0	94	3182	0
Right Turn on Red			Yes			Yes			Yes			Yes
Satd. Flow (RTOR)		5				430		4			1	
Link Speed (mph)		30			30			35			30	
Link Distance (ft)		327			632			348			307	
Travel Time (s)		7.4			14.4			6.8			7.0	
Confl. Peds. (#/hr)			12						1			
Peak Hour Factor	0.79	0.79	0.79	0.77	0.77	0.77	0.99	0.99	0.99	0.95	0.95	0.95
Heavy Vehicles (%)	3%	3%	3%	1%	1%	1%	2%	2%	2%	2%	2%	2%
Adj. Flow (vph)	8	5	5	16	4	791	0	1483	56	467	1301	7
Shared Lane Traffic (%)												
Lane Group Flow (vph)	0	18	0	0	20	791	0	1539	0	467	1308	0
Enter Blocked Intersection	No	No	No	No	No	No	No	No	No	No	No	No
Lane Alignment	Left	Left	Right	Left	Left	Right	Left	Left	Right	Left	Left	Right
Median Width(ft)		0			0			12			12	
Link Offset(ft)		0			0			0			0	
Crosswalk Width(ft)		10			0			10			10	
Two way Left Turn Lane												
Headway Factor	1.14	1.14	1.14	1.14	1.14	1.14	1.14	1.14	1.14	1.14	1.14	1.14
Turning Speed (mph)	15		9	15		9	15		9	15		9
Number of Detectors	1	1		1	1	1	1	1		1	1	
Detector Template	Left					Right		Thru		Left	Thru	
Leading Detector (ft)	20	24		50	24	24	24	24		24	24	
Trailing Detector (ft)	0	-6		0	-6	-6	-6	-6		-6	-6	
Detector 1 Position(ft)	0	-6		0	-6	-6	-6	-6		-6	-6	
Detector 1 Size(ft)	20	30		50	30	30	30	30		30	30	
Detector 1 Type	Cl+Ex	Cl+Ex		Cl+Ex	Cl+Ex	Cl+Ex	Cl+Ex	Cl+Ex		Cl+Ex	Cl+Ex	
Detector 1 Channel												
Detector 1 Extend (s)	0.0	0.0		0.0	0.0	0.0	0.0	0.0		0.0	0.0	
Detector 1 Queue (s)	0.0	0.0		0.0	0.0	0.0	0.0	0.0		0.0	0.0	
Detector 1 Delay (s)	0.0	0.0		0.0	0.0	0.0	0.0	0.0		0.0	0.0	
Turn Type	Perm	NA		Perm	NA	Free	Perm	NA		pm+pt	NA	
Protected Phases		4			8			2		1	6	
Permitted Phases	4			8		Free	2			6		
Detector Phase	4	4		8	8			2		1	6	
Switch Phase												
Minimum Initial (s)	7.0	7.0		7.0	7.0		7.0	7.0		5.0	4.0	

Lanes, Volumes, Timings
54: Alton Rd & N Michigan Ave

5/13/2015

Lane Group	SEL	SET	SER	NWL	NWT	NWR	NEL	NET	NER	SWL	SWT	SWR
Minimum Split (s)	37.0	37.0		37.0	37.0		26.0	26.0		8.0	37.0	
Total Split (s)	37.0	37.0		37.0	37.0		76.0	76.0		17.0	93.0	
Total Split (%)	28.5%	28.5%		28.5%	28.5%		58.5%	58.5%		13.1%	71.5%	
Maximum Green (s)	32.0	32.0		32.0	32.0		71.0	71.0		14.0	88.0	
Yellow Time (s)	4.0	4.0		4.0	4.0		4.0	4.0		3.0	4.0	
All-Red Time (s)	1.0	1.0		1.0	1.0		1.0	1.0		0.0	1.0	
Lost Time Adjust (s)		2.5			2.5		2.5	2.5		2.5	2.5	
Total Lost Time (s)		7.5			7.5		7.5	7.5		5.5	7.5	
Lead/Lag							Lag	Lag		Lead		
Lead-Lag Optimize?							Yes	Yes		Yes		
Vehicle Extension (s)	2.5	2.5		2.5	2.5		1.0	1.0		3.0	3.0	
Recall Mode	None	None		None	None		C-Max	C-Max		None	None	
Walk Time (s)	7.0	7.0		7.0	7.0		7.0	7.0			7.0	
Flash Dont Walk (s)	25.0	25.0		25.0	25.0		14.0	14.0			25.0	
Pedestrian Calls (#/hr)	0	0		0	0		0	0			0	
Act Effect Green (s)		5.2			5.2	130.0		68.5		119.0	121.5	
Actuated g/C Ratio		0.04			0.04	1.00		0.53		0.92	0.93	
v/c Ratio		0.26			0.29	0.55		0.92		0.80	0.44	
Control Delay		57.5			71.2	1.5		38.5		44.8	2.0	
Queue Delay		0.0			0.0	0.0		46.3		0.0	0.0	
Total Delay		57.5			71.2	1.5		84.9		44.8	2.0	
LOS		E			E	A		F		D	A	
Approach Delay		57.5			3.2			84.9			13.2	
Approach LOS		E			A			F			B	

Intersection Summary

Area Type: CBD

Cycle Length: 130

Actuated Cycle Length: 130

Offset: 67 (52%), Referenced to phase 2:NETL, Start of Yellow

Natural Cycle: 150

Control Type: Actuated-Coordinated

Maximum v/c Ratio: 0.92

Intersection Signal Delay: 38.1

Intersection LOS: D

Intersection Capacity Utilization 105.0%

ICU Level of Service G

Analysis Period (min) 15

Splits and Phases: 54: Alton Rd & N Michigan Ave

01	02 (R)	04
17 s	76 s	37 s
06		08
93 s		37 s

Queues

54: Alton Rd & N Michigan Ave

5/13/2015

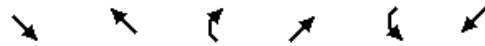

Lane Group	SET	NWT	NWR	NET	SWL	SWT
Lane Group Flow (vph)	18	20	791	1539	467	1308
v/c Ratio	0.26	0.29	0.55	0.92	0.80	0.44
Control Delay	57.5	71.2	1.5	38.5	44.8	2.0
Queue Delay	0.0	0.0	0.0	46.3	0.0	0.0
Total Delay	57.5	71.2	1.5	84.9	44.8	2.0
Queue Length 50th (ft)	11	17	0	605	277	0
Queue Length 95th (ft)	32	38	0	#754	#574	159
Internal Link Dist (ft)	247	552		268		227
Turn Bay Length (ft)					215	
Base Capacity (vph)	363	384	1439	1671	581	2973
Starvation Cap Reductn	0	0	0	543	0	0
Spillback Cap Reductn	0	0	0	0	0	0
Storage Cap Reductn	0	0	0	0	0	0
Reduced v/c Ratio	0.05	0.05	0.55	1.36	0.80	0.44

Intersection Summary

95th percentile volume exceeds capacity, queue may be longer.
 Queue shown is maximum after two cycles.

Lanes, Volumes, Timings
54: Alton Rd & N Michigan Ave

5/13/2015

Lane Group	SEL	SET	SER	NWL	NWT	NWR	NEL	NET	NER	SWL	SWT	SWR
Lane Configurations		↕			↕	↕	↕	↕↔		↕	↕↔	
Volume (vph)	6	4	4	13	3	621	0	1498	56	453	1261	7
Ideal Flow (vphpl)	1900	1900	1900	1900	1900	1900	1900	1900	1900	1900	1900	1900
Storage Length (ft)	0		0	0		0	100		0	215		0
Storage Lanes	0		0	0		1	1		0	1		0
Taper Length (ft)	25			25			25			25		
Lane Util. Factor	1.00	1.00	1.00	1.00	1.00	1.00	1.00	0.95	0.95	1.00	0.95	0.95
Ped Bike Factor		0.99						1.00				
Frt		0.962				0.850		0.995			0.999	
Flt Protected		0.978			0.961					0.950		
Satd. Flow (prot)	0	1551	0	0	1627	1439	1676	3168	0	1593	3182	0
Flt Permitted										0.056		
Satd. Flow (perm)	0	1585	0	0	1693	1439	1676	3168	0	94	3182	0
Right Turn on Red			Yes			Yes			Yes			Yes
Satd. Flow (RTOR)		5				429		4			1	
Link Speed (mph)		30			30			35			30	
Link Distance (ft)		327			632			348			307	
Travel Time (s)		7.4			14.4			6.8			7.0	
Confl. Peds. (#/hr)			12						1			
Peak Hour Factor	0.79	0.79	0.79	0.77	0.77	0.77	0.99	0.99	0.99	0.95	0.95	0.95
Heavy Vehicles (%)	3%	3%	3%	1%	1%	1%	2%	2%	2%	2%	2%	2%
Adj. Flow (vph)	8	5	5	17	4	806	0	1513	57	477	1327	7
Shared Lane Traffic (%)												
Lane Group Flow (vph)	0	18	0	0	21	806	0	1570	0	477	1334	0
Enter Blocked Intersection	No	No	No	No	No	No	No	No	No	No	No	No
Lane Alignment	Left	Left	Right	Left	Left	Right	Left	Left	Right	Left	Left	Right
Median Width(ft)		0			0			12			12	
Link Offset(ft)		0			0			0			0	
Crosswalk Width(ft)		10			0			10			10	
Two way Left Turn Lane												
Headway Factor	1.14	1.14	1.14	1.14	1.14	1.14	1.14	1.14	1.14	1.14	1.14	1.14
Turning Speed (mph)	15		9	15		9	15		9	15		9
Number of Detectors	1	1		1	1	1	1	1		1	1	
Detector Template	Left					Right		Thru		Left	Thru	
Leading Detector (ft)	20	24		50	24	24	24	24		24	24	
Trailing Detector (ft)	0	-6		0	-6	-6	-6	-6		-6	-6	
Detector 1 Position(ft)	0	-6		0	-6	-6	-6	-6		-6	-6	
Detector 1 Size(ft)	20	30		50	30	30	30	30		30	30	
Detector 1 Type	Cl+Ex	Cl+Ex		Cl+Ex	Cl+Ex	Cl+Ex	Cl+Ex	Cl+Ex		Cl+Ex	Cl+Ex	
Detector 1 Channel												
Detector 1 Extend (s)	0.0	0.0		0.0	0.0	0.0	0.0	0.0		0.0	0.0	
Detector 1 Queue (s)	0.0	0.0		0.0	0.0	0.0	0.0	0.0		0.0	0.0	
Detector 1 Delay (s)	0.0	0.0		0.0	0.0	0.0	0.0	0.0		0.0	0.0	
Turn Type	Perm	NA		Perm	NA	Free	Perm	NA		pm+pt	NA	
Protected Phases		4			8			2		1	6	
Permitted Phases	4			8		Free	2			6		
Detector Phase	4	4		8	8			2		1	6	
Switch Phase												
Minimum Initial (s)	7.0	7.0		7.0	7.0		7.0	7.0		5.0	4.0	

Lanes, Volumes, Timings
54: Alton Rd & N Michigan Ave

5/13/2015

Lane Group	SEL	SET	SER	NWL	NWT	NWR	NEL	NET	NER	SWL	SWT	SWR
Minimum Split (s)	37.0	37.0		37.0	37.0		26.0	26.0		8.0	37.0	
Total Split (s)	37.0	37.0		37.0	37.0		76.0	76.0		17.0	93.0	
Total Split (%)	28.5%	28.5%		28.5%	28.5%		58.5%	58.5%		13.1%	71.5%	
Maximum Green (s)	32.0	32.0		32.0	32.0		71.0	71.0		14.0	88.0	
Yellow Time (s)	4.0	4.0		4.0	4.0		4.0	4.0		3.0	4.0	
All-Red Time (s)	1.0	1.0		1.0	1.0		1.0	1.0		0.0	1.0	
Lost Time Adjust (s)		2.5			2.5		2.5	2.5		2.5	2.5	
Total Lost Time (s)		7.5			7.5		7.5	7.5		5.5	7.5	
Lead/Lag							Lag	Lag		Lead		
Lead-Lag Optimize?							Yes	Yes		Yes		
Vehicle Extension (s)	2.5	2.5		2.5	2.5		1.0	1.0		3.0	3.0	
Recall Mode	None	None		None	None		C-Max	C-Max		None	None	
Walk Time (s)	7.0	7.0		7.0	7.0		7.0	7.0			7.0	
Flash Dont Walk (s)	25.0	25.0		25.0	25.0		14.0	14.0			25.0	
Pedestrian Calls (#/hr)	0	0		0	0		0	0			0	
Act Effect Green (s)		5.3			5.3	130.0		68.5		116.5	117.5	
Actuated g/C Ratio		0.04			0.04	1.00		0.53		0.90	0.90	
v/c Ratio		0.26			0.30	0.56		0.94		0.87	0.46	
Control Delay		57.1			71.4	1.6		40.9		52.4	2.6	
Queue Delay		0.0			0.0	0.0		45.4		0.0	0.0	
Total Delay		57.1			71.4	1.6		86.3		52.4	2.6	
LOS		E			E	A		F		D	A	
Approach Delay		57.1			3.4			86.3			15.7	
Approach LOS		E			A			F			B	

Intersection Summary

Area Type: CBD
 Cycle Length: 130
 Actuated Cycle Length: 130
 Offset: 67 (52%), Referenced to phase 2:NETL, Start of Yellow
 Natural Cycle: 150
 Control Type: Actuated-Coordinated
 Maximum v/c Ratio: 0.94
 Intersection Signal Delay: 39.7
 Intersection LOS: D
 Intersection Capacity Utilization 106.5%
 ICU Level of Service G
 Analysis Period (min) 15

Splits and Phases: 54: Alton Rd & N Michigan Ave

01	02 (R)	04
17 s	76 s	37 s
06		08
93 s		37 s

Queues

54: Alton Rd & N Michigan Ave

5/13/2015



Lane Group	SET	NWT	NWR	NET	SWL	SWT
Lane Group Flow (vph)	18	21	806	1570	477	1334
v/c Ratio	0.26	0.30	0.56	0.94	0.87	0.46
Control Delay	57.1	71.4	1.6	40.9	52.4	2.6
Queue Delay	0.0	0.0	0.0	45.4	0.0	0.0
Total Delay	57.1	71.4	1.6	86.3	52.4	2.6
Queue Length 50th (ft)	11	18	0	629	343	113
Queue Length 95th (ft)	32	39	0	#816	#594	166
Internal Link Dist (ft)	247	552		268		227
Turn Bay Length (ft)					215	
Base Capacity (vph)	363	384	1439	1671	551	2875
Starvation Cap Reductn	0	0	0	531	0	0
Spillback Cap Reductn	0	0	0	0	0	0
Storage Cap Reductn	0	0	0	0	0	0
Reduced v/c Ratio	0.05	0.05	0.56	1.38	0.87	0.46

Intersection Summary

95th percentile volume exceeds capacity, queue may be longer.

Queue shown is maximum after two cycles.

Lanes, Volumes, Timings
54: Alton Rd & N Michigan Ave

5/13/2015

Lane Group	SEL	SET	SER	NWL	NWT	NWR	NEL	NET	NER	SWL	SWT	SWR
Lane Configurations		↕			↕	↕	↕	↕↔		↕	↕↔	
Volume (vph)	6	19	4	13	3	621	14	1554	71	511	1261	7
Ideal Flow (vphpl)	1900	1900	1900	1900	1900	1900	1900	1900	1900	1900	1900	1900
Storage Length (ft)	0		0	0		0	100		0	215		0
Storage Lanes	0		0	0		1	1		0	1		0
Taper Length (ft)	25			25			25			25		
Lane Util. Factor	1.00	1.00	1.00	1.00	1.00	1.00	1.00	0.95	0.95	1.00	0.95	0.95
Ped Bike Factor		1.00						1.00				
Frt		0.982				0.850		0.993			0.999	
Flt Protected		0.989			0.961		0.950			0.950		
Satd. Flow (prot)	0	1607	0	0	1627	1439	1593	3161	0	1593	3182	0
Flt Permitted		0.919					0.205			0.056		
Satd. Flow (perm)	0	1493	0	0	1693	1439	344	3161	0	94	3182	0
Right Turn on Red			Yes			Yes			Yes			Yes
Satd. Flow (RTOR)		5				427		5			1	
Link Speed (mph)		30			30			35			30	
Link Distance (ft)		327			632			348			307	
Travel Time (s)		7.4			14.4			6.8			7.0	
Confl. Peds. (#/hr)			12						1			
Peak Hour Factor	0.79	0.79	0.79	0.77	0.77	0.77	0.99	0.99	0.99	0.95	0.95	0.95
Heavy Vehicles (%)	3%	3%	3%	1%	1%	1%	2%	2%	2%	2%	2%	2%
Adj. Flow (vph)	8	24	5	17	4	806	14	1570	72	538	1327	7
Shared Lane Traffic (%)												
Lane Group Flow (vph)	0	37	0	0	21	806	14	1642	0	538	1334	0
Enter Blocked Intersection	No	No	No	No	No	No	No	No	No	No	No	No
Lane Alignment	Left	Left	Right	Left	Left	Right	Left	Left	Right	Left	Left	Right
Median Width(ft)		0			0			12			12	
Link Offset(ft)		0			0			0			0	
Crosswalk Width(ft)		10			0			10			10	
Two way Left Turn Lane												
Headway Factor	1.14	1.14	1.14	1.14	1.14	1.14	1.14	1.14	1.14	1.14	1.14	1.14
Turning Speed (mph)	15		9	15		9	15		9	15		9
Number of Detectors	1	1		1	1	1	1	1		1	1	
Detector Template	Left					Right		Thru		Left	Thru	
Leading Detector (ft)	20	24		50	24	24	24	24		24	24	
Trailing Detector (ft)	0	-6		0	-6	-6	-6	-6		-6	-6	
Detector 1 Position(ft)	0	-6		0	-6	-6	-6	-6		-6	-6	
Detector 1 Size(ft)	20	30		50	30	30	30	30		30	30	
Detector 1 Type	Cl+Ex	Cl+Ex		Cl+Ex	Cl+Ex	Cl+Ex	Cl+Ex	Cl+Ex		Cl+Ex	Cl+Ex	
Detector 1 Channel												
Detector 1 Extend (s)	0.0	0.0		0.0	0.0	0.0	0.0	0.0		0.0	0.0	
Detector 1 Queue (s)	0.0	0.0		0.0	0.0	0.0	0.0	0.0		0.0	0.0	
Detector 1 Delay (s)	0.0	0.0		0.0	0.0	0.0	0.0	0.0		0.0	0.0	
Turn Type	Perm	NA		Perm	NA	Free	Perm	NA		pm+pt	NA	
Protected Phases		4			8			2		1	6	
Permitted Phases	4			8		Free	2			6		
Detector Phase	4	4		8	8			2		1	6	
Switch Phase												
Minimum Initial (s)	7.0	7.0		7.0	7.0		7.0	7.0		5.0	4.0	

Lanes, Volumes, Timings
54: Alton Rd & N Michigan Ave

5/13/2015

Lane Group	SEL	SET	SER	NWL	NWT	NWR	NEL	NET	NER	SWL	SWT	SWR
Minimum Split (s)	37.0	37.0		37.0	37.0		26.0	26.0		8.0	37.0	
Total Split (s)	37.0	37.0		37.0	37.0		76.0	76.0		17.0	93.0	
Total Split (%)	28.5%	28.5%		28.5%	28.5%		58.5%	58.5%		13.1%	71.5%	
Maximum Green (s)	32.0	32.0		32.0	32.0		71.0	71.0		14.0	88.0	
Yellow Time (s)	4.0	4.0		4.0	4.0		4.0	4.0		3.0	4.0	
All-Red Time (s)	1.0	1.0		1.0	1.0		1.0	1.0		0.0	1.0	
Lost Time Adjust (s)		2.5			2.5		2.5	2.5		2.5	2.5	
Total Lost Time (s)		7.5			7.5		7.5	7.5		5.5	7.5	
Lead/Lag							Lag	Lag		Lead		
Lead-Lag Optimize?							Yes	Yes		Yes		
Vehicle Extension (s)	2.5	2.5		2.5	2.5		1.0	1.0		3.0	3.0	
Recall Mode	None	None		None	None		C-Max	C-Max		None	None	
Walk Time (s)	7.0	7.0		7.0	7.0		7.0	7.0			7.0	
Flash Dont Walk (s)	25.0	25.0		25.0	25.0		14.0	14.0			25.0	
Pedestrian Calls (#/hr)	0	0		0	0		0	0			0	
Act Effect Green (s)		5.9			5.9	130.0	68.5	68.5		115.9	116.9	
Actuated g/C Ratio		0.05			0.05	1.00	0.53	0.53		0.89	0.90	
v/c Ratio		0.51			0.27	0.56	0.08	0.99		0.99	0.47	
Control Delay		77.3			67.9	1.6	16.7	49.2		74.7	2.8	
Queue Delay		0.0			0.0	0.0	0.0	40.5		0.0	0.0	
Total Delay		77.3			67.9	1.6	16.7	89.7		74.7	2.8	
LOS		E			E	A	B	F		E	A	
Approach Delay		77.3			3.3			89.1			23.5	
Approach LOS		E			A			F			C	

Intersection Summary

Area Type: CBD
 Cycle Length: 130
 Actuated Cycle Length: 130
 Offset: 67 (52%), Referenced to phase 2:NETL, Start of Yellow
 Natural Cycle: 150
 Control Type: Actuated-Coordinated
 Maximum v/c Ratio: 0.99
 Intersection Signal Delay: 44.9
 Intersection LOS: D
 Intersection Capacity Utilization 112.6%
 ICU Level of Service H
 Analysis Period (min) 15







Splits and Phases: 54: Alton Rd & N Michigan Ave

01	02 (R)	04
17 s	76 s	37 s
06		08
93 s		37 s

Queues

54: Alton Rd & N Michigan Ave

5/13/2015

							
Lane Group	SET	NWT	NWR	NEL	NET	SWL	SWT
Lane Group Flow (vph)	37	21	806	14	1642	538	1334
v/c Ratio	0.51	0.27	0.56	0.08	0.99	0.99	0.47
Control Delay	77.3	67.9	1.6	16.7	49.2	74.7	2.8
Queue Delay	0.0	0.0	0.0	0.0	40.5	0.0	0.0
Total Delay	77.3	67.9	1.6	16.7	89.7	74.7	2.8
Queue Length 50th (ft)	27	18	0	6	690	~462	120
Queue Length 95th (ft)	55	39	0	18	#885	#726	180
Internal Link Dist (ft)	247	552			268		227
Turn Bay Length (ft)				100		215	
Base Capacity (vph)	342	384	1439	181	1667	543	2860
Starvation Cap Reductn	0	0	0	0	502	0	0
Spillback Cap Reductn	0	0	0	0	0	0	0
Storage Cap Reductn	0	0	0	0	0	0	0
Reduced v/c Ratio	0.11	0.05	0.56	0.08	1.41	0.99	0.47

Intersection Summary

- ~ Volume exceeds capacity, queue is theoretically infinite.
Queue shown is maximum after two cycles.
- # 95th percentile volume exceeds capacity, queue may be longer.
Queue shown is maximum after two cycles.

Lanes, Volumes, Timings
54: Alton Rd & N Michigan Ave

5/13/2015

Lane Group	SEL	SET	SER	NWL	NWT	NWR	NEL	NET	NER	SWL	SWT	SWR
Lane Configurations		↕			↕	↕	↕	↕↔		↕	↕↔	
Volume (vph)	6	19	4	13	3	621	14	1554	71	511	1261	7
Ideal Flow (vphpl)	1900	1900	1900	1900	1900	1900	1900	1900	1900	1900	1900	1900
Storage Length (ft)	0		0	0		0	100		0	215		0
Storage Lanes	0		0	0		1	1		0	1		0
Taper Length (ft)	25			25			25			25		
Lane Util. Factor	1.00	1.00	1.00	1.00	1.00	1.00	1.00	0.95	0.95	1.00	0.95	0.95
Ped Bike Factor		1.00						1.00				
Frt		0.982				0.850		0.993			0.999	
Flt Protected		0.989			0.961		0.950			0.950		
Satd. Flow (prot)	0	1607	0	0	1627	1439	1593	3161	0	1593	3182	0
Flt Permitted		0.919					0.205			0.070		
Satd. Flow (perm)	0	1493	0	0	1693	1439	344	3161	0	117	3182	0
Right Turn on Red			Yes			Yes			Yes			Yes
Satd. Flow (RTOR)		5				558		4			1	
Link Speed (mph)		30			30			35			30	
Link Distance (ft)		327			632			348			307	
Travel Time (s)		7.4			14.4			6.8			7.0	
Confl. Peds. (#/hr)			12						1			
Peak Hour Factor	0.79	0.79	0.79	0.77	0.77	0.77	0.99	0.99	0.99	0.95	0.95	0.95
Heavy Vehicles (%)	3%	3%	3%	1%	1%	1%	2%	2%	2%	2%	2%	2%
Adj. Flow (vph)	8	24	5	17	4	806	14	1570	72	538	1327	7
Shared Lane Traffic (%)												
Lane Group Flow (vph)	0	37	0	0	21	806	14	1642	0	538	1334	0
Enter Blocked Intersection	No	No	No	No	No	No	No	No	No	No	No	No
Lane Alignment	Left	Left	Right	Left	Left	Right	Left	Left	Right	Left	Left	Right
Median Width(ft)		0			0			12			12	
Link Offset(ft)		0			0			0			0	
Crosswalk Width(ft)		10			0			10			10	
Two way Left Turn Lane												
Headway Factor	1.14	1.14	1.14	1.14	1.14	1.14	1.14	1.14	1.14	1.14	1.14	1.14
Turning Speed (mph)	15		9	15		9	15		9	15		9
Number of Detectors	1	1		1	1	1	1	1		1	1	
Detector Template	Left					Right		Thru		Left	Thru	
Leading Detector (ft)	20	24		50	24	24	24	24		24	24	
Trailing Detector (ft)	0	-6		0	-6	-6	-6	-6		-6	-6	
Detector 1 Position(ft)	0	-6		0	-6	-6	-6	-6		-6	-6	
Detector 1 Size(ft)	20	30		50	30	30	30	30		30	30	
Detector 1 Type	Cl+Ex	Cl+Ex		Cl+Ex	Cl+Ex	Cl+Ex	Cl+Ex	Cl+Ex		Cl+Ex	Cl+Ex	
Detector 1 Channel												
Detector 1 Extend (s)	0.0	0.0		0.0	0.0	0.0	0.0	0.0		0.0	0.0	
Detector 1 Queue (s)	0.0	0.0		0.0	0.0	0.0	0.0	0.0		0.0	0.0	
Detector 1 Delay (s)	0.0	0.0		0.0	0.0	0.0	0.0	0.0		0.0	0.0	
Turn Type	Perm	NA		Perm	NA	Free	Perm	NA		pm+pt	NA	
Protected Phases		4			8			2		1	6	
Permitted Phases	4			8		Free	2			6		
Detector Phase	4	4		8	8			2		1	6	
Switch Phase												
Minimum Initial (s)	7.0	7.0		7.0	7.0		7.0	7.0		5.0	4.0	

Lanes, Volumes, Timings
54: Alton Rd & N Michigan Ave

5/13/2015

Lane Group	SEL	SET	SER	NWL	NWT	NWR	NEL	NET	NER	SWL	SWT	SWR
Minimum Split (s)	37.0	37.0		37.0	37.0		26.0	26.0		8.0	37.0	
Total Split (s)	37.0	37.0		37.0	37.0		61.0	61.0		32.0	93.0	
Total Split (%)	28.5%	28.5%		28.5%	28.5%		46.9%	46.9%		24.6%	71.5%	
Maximum Green (s)	32.0	32.0		32.0	32.0		56.0	56.0		29.0	88.0	
Yellow Time (s)	4.0	4.0		4.0	4.0		4.0	4.0		3.0	4.0	
All-Red Time (s)	1.0	1.0		1.0	1.0		1.0	1.0		0.0	1.0	
Lost Time Adjust (s)		2.5			2.5		2.5	2.5		2.5	2.5	
Total Lost Time (s)		7.5			7.5		7.5	7.5		5.5	7.5	
Lead/Lag							Lag	Lag		Lead		
Lead-Lag Optimize?							Yes	Yes		Yes		
Vehicle Extension (s)	2.5	2.5		2.5	2.5		1.0	1.0		3.0	3.0	
Recall Mode	None	None		None	None		C-Max	C-Max		None	None	
Walk Time (s)	7.0	7.0		7.0	7.0		7.0	7.0			7.0	
Flash Dont Walk (s)	25.0	25.0		25.0	25.0		14.0	14.0			25.0	
Pedestrian Calls (#/hr)	0	0		0	0		0	0			0	
Act Effect Green (s)		5.9			5.9	130.0	53.5	53.5		115.9	116.9	
Actuated g/C Ratio		0.05			0.05	1.00	0.41	0.41		0.89	0.90	
v/c Ratio		0.51			0.27	0.56	0.10	1.26		0.74	0.47	
Control Delay		77.3			67.9	1.6	25.9	157.2		33.9	2.8	
Queue Delay		0.0			0.0	0.0	0.0	1.3		0.0	0.0	
Total Delay		77.3			67.9	1.6	25.9	158.6		33.9	2.8	
LOS		E			E	A	C	F		C	A	
Approach Delay		77.3			3.3			157.4			11.7	
Approach LOS		E			A			F			B	

Intersection Summary

Area Type:	CBD
Cycle Length:	130
Actuated Cycle Length:	130
Offset:	67 (52%), Referenced to phase 2:NETL, Start of Yellow
Natural Cycle:	150
Control Type:	Actuated-Coordinated
Maximum v/c Ratio:	1.26
Intersection Signal Delay:	65.6
Intersection LOS:	E
Intersection Capacity Utilization	112.6%
ICU Level of Service	H
Analysis Period (min)	15

Splits and Phases: 54: Alton Rd & N Michigan Ave

01	02 (R)	04
32 s	61 s	37 s
06		08
93 s		37 s

Queues

54: Alton Rd & N Michigan Ave

5/13/2015



Lane Group	SET	NWT	NWR	NEL	NET	SWL	SWT
Lane Group Flow (vph)	37	21	806	14	1642	538	1334
v/c Ratio	0.51	0.27	0.56	0.10	1.26	0.74	0.47
Control Delay	77.3	67.9	1.6	25.9	157.2	33.9	2.8
Queue Delay	0.0	0.0	0.0	0.0	1.3	0.0	0.0
Total Delay	77.3	67.9	1.6	25.9	158.6	33.9	2.8
Queue Length 50th (ft)	27	18	0	7	~916	339	120
Queue Length 95th (ft)	55	39	0	23	#1058	#560	180
Internal Link Dist (ft)	247	552			268		227
Turn Bay Length (ft)				100		215	
Base Capacity (vph)	342	384	1439	141	1303	727	2860
Starvation Cap Reductn	0	0	0	0	336	0	0
Spillback Cap Reductn	0	0	0	0	0	0	0
Storage Cap Reductn	0	0	0	0	0	0	0
Reduced v/c Ratio	0.11	0.05	0.56	0.10	1.70	0.74	0.47

Intersection Summary

- ~ Volume exceeds capacity, queue is theoretically infinite.
Queue shown is maximum after two cycles.
- # 95th percentile volume exceeds capacity, queue may be longer.
Queue shown is maximum after two cycles.

Lanes, Volumes, Timings
54: Alton Rd & N Michigan Ave

5/13/2015

Lane Group	SEL	SET	SER	NWL	NWT	NWR	NEL	NET	NER	SWL	SWT	SWR
Lane Configurations		↕			↕	↕	↕	↕↔		↕↔	↕↔	
Volume (vph)	6	19	4	13	3	621	14	1554	71	511	1261	7
Ideal Flow (vphpl)	1900	1900	1900	1900	1900	1900	1900	1900	1900	1900	1900	1900
Storage Length (ft)	0		0	0		0	100		0	215		0
Storage Lanes	0		0	0		1	1		0	2		0
Taper Length (ft)	25			25			25			25		
Lane Util. Factor	1.00	1.00	1.00	1.00	1.00	1.00	1.00	0.95	0.95	0.97	0.95	0.95
Ped Bike Factor		1.00						1.00				
Frt		0.982				0.850		0.993			0.999	
Flt Protected		0.989			0.961		0.950			0.950		
Satd. Flow (prot)	0	1607	0	0	1627	1439	1593	3161	0	3090	3182	0
Flt Permitted		0.919					0.205			0.950		
Satd. Flow (perm)	0	1493	0	0	1693	1439	344	3161	0	3090	3182	0
Right Turn on Red			Yes			Yes			Yes			Yes
Satd. Flow (RTOR)		5				496		5			1	
Link Speed (mph)		30			30			35			30	
Link Distance (ft)		327			632			348			307	
Travel Time (s)		7.4			14.4			6.8			7.0	
Confl. Peds. (#/hr)			12						1			
Peak Hour Factor	0.79	0.79	0.79	0.77	0.77	0.77	0.99	0.99	0.99	0.95	0.95	0.95
Heavy Vehicles (%)	3%	3%	3%	1%	1%	1%	2%	2%	2%	2%	2%	2%
Adj. Flow (vph)	8	24	5	17	4	806	14	1570	72	538	1327	7
Shared Lane Traffic (%)												
Lane Group Flow (vph)	0	37	0	0	21	806	14	1642	0	538	1334	0
Enter Blocked Intersection	No	No	No	No	No	No	No	No	No	No	No	No
Lane Alignment	Left	Left	Right	Left	Left	Right	Left	Left	Right	Left	Left	Right
Median Width(ft)		0			0			24			24	
Link Offset(ft)		0			0			0			0	
Crosswalk Width(ft)		10			0			10			10	
Two way Left Turn Lane												
Headway Factor	1.14	1.14	1.14	1.14	1.14	1.14	1.14	1.14	1.14	1.14	1.14	1.14
Turning Speed (mph)	15		9	15		9	15		9	15		9
Number of Detectors	1	1		1	1	1	1	1		1	1	
Detector Template	Left					Right		Thru		Left	Thru	
Leading Detector (ft)	20	24		50	24	24	24	24		24	24	
Trailing Detector (ft)	0	-6		0	-6	-6	-6	-6		-6	-6	
Detector 1 Position(ft)	0	-6		0	-6	-6	-6	-6		-6	-6	
Detector 1 Size(ft)	20	30		50	30	30	30	30		30	30	
Detector 1 Type	Cl+Ex	Cl+Ex		Cl+Ex	Cl+Ex	Cl+Ex	Cl+Ex	Cl+Ex		Cl+Ex	Cl+Ex	
Detector 1 Channel												
Detector 1 Extend (s)	0.0	0.0		0.0	0.0	0.0	0.0	0.0		0.0	0.0	
Detector 1 Queue (s)	0.0	0.0		0.0	0.0	0.0	0.0	0.0		0.0	0.0	
Detector 1 Delay (s)	0.0	0.0		0.0	0.0	0.0	0.0	0.0		0.0	0.0	
Turn Type	Perm	NA		Perm	NA	Free	Perm	NA		Prot	NA	
Protected Phases		4			8			2		1	6	
Permitted Phases	4			8		Free	2					
Detector Phase	4	4		8	8			2		1	6	
Switch Phase												
Minimum Initial (s)	7.0	7.0		7.0	7.0		7.0	7.0		5.0	4.0	

Lanes, Volumes, Timings
54: Alton Rd & N Michigan Ave

5/13/2015

Lane Group	SEL	SET	SER	NWL	NWT	NWR	NEL	NET	NER	SWL	SWT	SWR
Minimum Split (s)	37.0	37.0		37.0	37.0		26.0	26.0		8.0	37.0	
Total Split (s)	37.0	37.0		37.0	37.0		68.0	68.0		25.0	93.0	
Total Split (%)	28.5%	28.5%		28.5%	28.5%		52.3%	52.3%		19.2%	71.5%	
Maximum Green (s)	32.0	32.0		32.0	32.0		63.0	63.0		22.0	88.0	
Yellow Time (s)	4.0	4.0		4.0	4.0		4.0	4.0		3.0	4.0	
All-Red Time (s)	1.0	1.0		1.0	1.0		1.0	1.0		0.0	1.0	
Lost Time Adjust (s)		2.5			2.5		2.5	2.5		2.5	2.5	
Total Lost Time (s)		7.5			7.5		7.5	7.5		5.5	7.5	
Lead/Lag							Lag	Lag		Lead		
Lead-Lag Optimize?							Yes	Yes		Yes		
Vehicle Extension (s)	2.5	2.5		2.5	2.5		1.0	1.0		3.0	3.0	
Recall Mode	None	None		None	None		C-Max	C-Max		None	None	
Walk Time (s)	7.0	7.0		7.0	7.0		7.0	7.0			7.0	
Flash Dont Walk (s)	25.0	25.0		25.0	25.0		14.0	14.0			25.0	
Pedestrian Calls (#/hr)	0	0		0	0		0	0			0	
Act Effect Green (s)		5.9			5.9	130.0	76.3	76.3		32.0	116.9	
Actuated g/C Ratio		0.05			0.05	1.00	0.59	0.59		0.25	0.90	
v/c Ratio		0.51			0.27	0.56	0.07	0.88		0.71	0.47	
Control Delay		77.3			67.9	1.6	14.8	30.9		51.1	2.8	
Queue Delay		0.0			0.0	0.0	0.0	47.0		0.0	0.0	
Total Delay		77.3			67.9	1.6	14.8	78.0		51.1	2.8	
LOS		E			E	A	B	E		D	A	
Approach Delay		77.3			3.3			77.4			16.7	
Approach LOS		E			A			E			B	

Intersection Summary

Area Type: CBD
 Cycle Length: 130
 Actuated Cycle Length: 130
 Offset: 67 (52%), Referenced to phase 2:NETL, Start of Yellow
 Natural Cycle: 150
 Control Type: Actuated-Coordinated
 Maximum v/c Ratio: 0.88
 Intersection Signal Delay: 37.6
 Intersection LOS: D
 Intersection Capacity Utilization 97.3%
 ICU Level of Service F
 Analysis Period (min) 15

Splits and Phases: 54: Alton Rd & N Michigan Ave

01	02 (R)	04
25 s	68 s	37 s
06		08
93 s		37 s

Queues

54: Alton Rd & N Michigan Ave

5/13/2015



Lane Group	SET	NWT	NWR	NEL	NET	SWL	SWT
Lane Group Flow (vph)	37	21	806	14	1642	538	1334
v/c Ratio	0.51	0.27	0.56	0.07	0.88	0.71	0.47
Control Delay	77.3	67.9	1.6	14.8	30.9	51.1	2.8
Queue Delay	0.0	0.0	0.0	0.0	47.0	0.0	0.0
Total Delay	77.3	67.9	1.6	14.8	78.0	51.1	2.8
Queue Length 50th (ft)	27	18	0	5	618	219	120
Queue Length 95th (ft)	55	39	0	18	#873	281	180
Internal Link Dist (ft)	247	552			268		227
Turn Bay Length (ft)				100		215	
Base Capacity (vph)	342	384	1439	201	1857	761	2860
Starvation Cap Reductn	0	0	0	0	550	0	0
Spillback Cap Reductn	0	0	0	0	0	0	0
Storage Cap Reductn	0	0	0	0	0	0	0
Reduced v/c Ratio	0.11	0.05	0.56	0.07	1.26	0.71	0.47

Intersection Summary

95th percentile volume exceeds capacity, queue may be longer.
 Queue shown is maximum after two cycles.

Lanes, Volumes, Timings
4: Dade Blvd & N Michigan Ave

5/13/2015

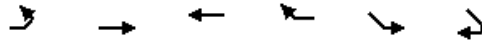

Lane Group	EBL	EBT	WBT	WBR	SEL	SER	ø3
Lane Configurations		↑↑	↑↑	↑	↘↘	↗	
Volume (vph)	0	412	712	815	759	113	
Ideal Flow (vphpl)	1900	1900	1900	1900	1900	1900	
Lane Width (ft)	10	10	10	10	10	10	
Storage Length (ft)	0			280	0	0	
Storage Lanes	0			1	2	1	
Taper Length (ft)	25				25		
Lane Util. Factor	1.00	0.95	0.95	1.00	0.97	1.00	
Ped Bike Factor							
Frt				0.850		0.850	
Flt Protected					0.950		
Satd. Flow (prot)	0	3271	3303	1478	3236	1492	
Flt Permitted					0.950		
Satd. Flow (perm)	0	3271	3303	1478	3236	1492	
Right Turn on Red				No		Yes	
Satd. Flow (RTOR)						122	
Link Speed (mph)		30	30		30		
Link Distance (ft)		246	421		91		
Travel Time (s)		5.6	9.6		2.1		
Confl. Peds. (#/hr)				36			
Peak Hour Factor	0.94	0.94	0.98	0.98	0.93	0.93	
Heavy Vehicles (%)	3%	3%	2%	2%	1%	1%	
Adj. Flow (vph)	0	438	727	832	816	122	
Shared Lane Traffic (%)							
Lane Group Flow (vph)	0	438	727	832	816	122	
Enter Blocked Intersection	No	No	No	No	No	No	
Lane Alignment	Left	Left	Left	Right	Left	Right	
Median Width(ft)		0	0		20		
Link Offset(ft)		0	0		0		
Crosswalk Width(ft)		0	0		10		
Two way Left Turn Lane							
Headway Factor	1.09	1.09	1.09	1.09	1.09	1.09	
Turning Speed (mph)	15			9	15	9	
Number of Detectors		0	0	1	1	1	
Detector Template				Right	Left	Right	
Leading Detector (ft)		0	0	24	24	24	
Trailing Detector (ft)		0	0	-6	-6	-6	
Detector 1 Position(ft)		0	0	-6	-6	-6	
Detector 1 Size(ft)		6	5	30	30	30	
Detector 1 Type		Cl+Ex	Cl+Ex	Cl+Ex	Cl+Ex	Cl+Ex	
Detector 1 Channel							
Detector 1 Extend (s)		0.0	0.0	0.0	0.0	0.0	
Detector 1 Queue (s)		0.0	0.0	0.0	0.0	0.0	
Detector 1 Delay (s)		0.0	0.0	0.0	0.0	0.0	
Turn Type		NA	NA	pt+ov	NA	Perm	
Protected Phases		6	2	2 4	4		3
Permitted Phases						4	
Detector Phase				2 4	4	4	
Switch Phase							

Lanes, Volumes, Timings
4: Dade Blvd & N Michigan Ave

5/13/2015

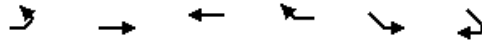

Lane Group	EBL	EBT	WBT	WBR	SEL	SER	ø3
Minimum Initial (s)		14.0	14.0		7.0	7.0	7.0
Minimum Split (s)		34.8	34.8		20.6	20.6	11.0
Total Split (s)		45.8	45.8		54.2	54.2	30.0
Total Split (%)		35.2%	35.2%		41.7%	41.7%	23%
Maximum Green (s)		41.0	41.0		49.6	49.6	26.0
Yellow Time (s)		4.0	4.0		4.0	4.0	3.5
All-Red Time (s)		0.8	0.8		0.6	0.6	0.5
Lost Time Adjust (s)		2.5	2.5		2.5	2.5	
Total Lost Time (s)		7.3	7.3		7.1	7.1	
Lead/Lag					Lag	Lag	Lead
Lead-Lag Optimize?					Yes	Yes	Yes
Vehicle Extension (s)		1.0	1.0		2.5	2.5	3.0
Recall Mode		Min	Min		None	None	None
Walk Time (s)		7.0	7.0				
Flash Dont Walk (s)		23.0	23.0				
Pedestrian Calls (#/hr)		36	10				
Act Effect Green (s)		17.6	17.6	57.5	24.1	24.1	
Actuated g/C Ratio		0.31	0.31	1.00	0.42	0.42	
v/c Ratio		0.44	0.72	0.56	0.60	0.18	
Control Delay		19.0	24.6	1.6	15.1	3.4	
Queue Delay		0.0	0.0	0.0	0.0	0.0	
Total Delay		19.0	24.6	1.6	15.1	3.4	
LOS		B	C	A	B	A	
Approach Delay		19.0	12.3		13.6		
Approach LOS		B	B		B		

Intersection Summary

Area Type: Other
 Cycle Length: 130
 Actuated Cycle Length: 57.5
 Natural Cycle: 75
 Control Type: Semi Act-Uncoord
 Maximum v/c Ratio: 0.72
 Intersection Signal Delay: 13.7
 Intersection Capacity Utilization 59.7%
 Analysis Period (min) 15
 Intersection LOS: B
 ICU Level of Service B

Splits and Phases: 4: Dade Blvd & N Michigan Ave

ø2	ø3	ø4
45.8 s	30 s	54.2 s
ø6		
45.8 s		

Queues

4: Dade Blvd & N Michigan Ave

5/13/2015



Lane Group	EBT	WBT	WBR	SEL	SER
Lane Group Flow (vph)	438	727	832	816	122
v/c Ratio	0.44	0.72	0.56	0.60	0.18
Control Delay	19.0	24.6	1.6	15.1	3.4
Queue Delay	0.0	0.0	0.0	0.0	0.0
Total Delay	19.0	24.6	1.6	15.1	3.4
Queue Length 50th (ft)	80	~174	0	77	0
Queue Length 95th (ft)	132	228	0	189	26
Internal Link Dist (ft)	166	341		11	
Turn Bay Length (ft)			280		
Base Capacity (vph)	1002	1011	1474	2618	1230
Starvation Cap Reductn	0	0	0	0	0
Spillback Cap Reductn	0	0	0	0	0
Storage Cap Reductn	0	0	0	0	0
Reduced v/c Ratio	0.44	0.72	0.56	0.31	0.10

Intersection Summary

~ Volume exceeds capacity, queue is theoretically infinite.
 Queue shown is maximum after two cycles.

Lanes, Volumes, Timings
4: Dade Blvd & N Michigan Ave

5/13/2015

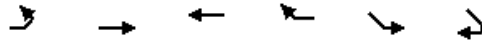

Lane Group	EBL	EBT	WBT	WBR	SEL	SER	ø3
Lane Configurations		↑↑	↑↑	↑	↘↘	↗	
Volume (vph)	0	420	727	832	774	116	
Ideal Flow (vphpl)	1900	1900	1900	1900	1900	1900	
Lane Width (ft)	10	10	10	10	10	10	
Storage Length (ft)	0			280	0	0	
Storage Lanes	0			1	2	1	
Taper Length (ft)	25				25		
Lane Util. Factor	1.00	0.95	0.95	1.00	0.97	1.00	
Ped Bike Factor							
Frt				0.850		0.850	
Flt Protected					0.950		
Satd. Flow (prot)	0	3271	3303	1478	3236	1492	
Flt Permitted					0.950		
Satd. Flow (perm)	0	3271	3303	1478	3236	1492	
Right Turn on Red				No		Yes	
Satd. Flow (RTOR)						125	
Link Speed (mph)		30	30		30		
Link Distance (ft)		246	421		91		
Travel Time (s)		5.6	9.6		2.1		
Confl. Peds. (#/hr)				36			
Peak Hour Factor	0.94	0.94	0.98	0.98	0.93	0.93	
Heavy Vehicles (%)	3%	3%	2%	2%	1%	1%	
Adj. Flow (vph)	0	447	742	849	832	125	
Shared Lane Traffic (%)							
Lane Group Flow (vph)	0	447	742	849	832	125	
Enter Blocked Intersection	No	No	No	No	No	No	
Lane Alignment	Left	Left	Left	Right	Left	Right	
Median Width(ft)		0	0		20		
Link Offset(ft)		0	0		0		
Crosswalk Width(ft)		0	0		10		
Two way Left Turn Lane							
Headway Factor	1.09	1.09	1.09	1.09	1.09	1.09	
Turning Speed (mph)	15			9	15	9	
Number of Detectors		0	0	1	1	1	
Detector Template				Right	Left	Right	
Leading Detector (ft)		0	0	24	24	24	
Trailing Detector (ft)		0	0	-6	-6	-6	
Detector 1 Position(ft)		0	0	-6	-6	-6	
Detector 1 Size(ft)		6	5	30	30	30	
Detector 1 Type		Cl+Ex	Cl+Ex	Cl+Ex	Cl+Ex	Cl+Ex	
Detector 1 Channel							
Detector 1 Extend (s)		0.0	0.0	0.0	0.0	0.0	
Detector 1 Queue (s)		0.0	0.0	0.0	0.0	0.0	
Detector 1 Delay (s)		0.0	0.0	0.0	0.0	0.0	
Turn Type		NA	NA	pt+ov	NA	Perm	
Protected Phases		6	2	2 4	4		3
Permitted Phases						4	
Detector Phase				2 4	4	4	
Switch Phase							

Lanes, Volumes, Timings
4: Dade Blvd & N Michigan Ave

5/13/2015

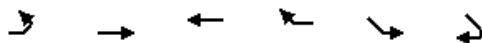

Lane Group	EBL	EBT	WBT	WBR	SEL	SER	ø3
Minimum Initial (s)		14.0	14.0		7.0	7.0	7.0
Minimum Split (s)		34.8	34.8		20.6	20.6	11.0
Total Split (s)		45.8	45.8		54.2	54.2	30.0
Total Split (%)		35.2%	35.2%		41.7%	41.7%	23%
Maximum Green (s)		41.0	41.0		49.6	49.6	26.0
Yellow Time (s)		4.0	4.0		4.0	4.0	3.5
All-Red Time (s)		0.8	0.8		0.6	0.6	0.5
Lost Time Adjust (s)		2.5	2.5		2.5	2.5	
Total Lost Time (s)		7.3	7.3		7.1	7.1	
Lead/Lag					Lag	Lag	Lead
Lead-Lag Optimize?					Yes	Yes	Yes
Vehicle Extension (s)		1.0	1.0		2.5	2.5	3.0
Recall Mode		Min	Min		None	None	None
Walk Time (s)		7.0	7.0				
Flash Dont Walk (s)		23.0	23.0				
Pedestrian Calls (#/hr)		36	10				
Act Effect Green (s)		17.7	17.7	59.0	25.3	25.3	
Actuated g/C Ratio		0.30	0.30	1.00	0.43	0.43	
v/c Ratio		0.46	0.75	0.57	0.60	0.18	
Control Delay		20.2	26.7	1.6	14.8	3.2	
Queue Delay		0.0	0.0	0.0	0.0	0.0	
Total Delay		20.2	26.7	1.6	14.8	3.2	
LOS		C	C	A	B	A	
Approach Delay		20.2	13.3		13.3		
Approach LOS		C	B		B		

Intersection Summary

Area Type: Other
 Cycle Length: 130
 Actuated Cycle Length: 59
 Natural Cycle: 75
 Control Type: Semi Act-Uncoord
 Maximum v/c Ratio: 0.75
 Intersection Signal Delay: 14.3
 Intersection Capacity Utilization 60.7%
 Analysis Period (min) 15
 Intersection LOS: B
 ICU Level of Service B

Splits and Phases: 4: Dade Blvd & N Michigan Ave

ø2	ø3	ø4
45.8 s	30 s	54.2 s
ø6		
45.8 s		

Queues

4: Dade Blvd & N Michigan Ave

5/13/2015



Lane Group	EBT	WBT	WBR	SEL	SER
Lane Group Flow (vph)	447	742	849	832	125
v/c Ratio	0.46	0.75	0.57	0.60	0.18
Control Delay	20.2	26.7	1.6	14.8	3.2
Queue Delay	0.0	0.0	0.0	0.0	0.0
Total Delay	20.2	26.7	1.6	14.8	3.2
Queue Length 50th (ft)	86	~190	0	79	0
Queue Length 95th (ft)	143	250	0	192	25
Internal Link Dist (ft)	166	341		11	
Turn Bay Length (ft)			280		
Base Capacity (vph)	981	990	1461	2578	1214
Starvation Cap Reductn	0	0	0	0	0
Spillback Cap Reductn	0	0	0	0	0
Storage Cap Reductn	0	0	0	0	0
Reduced v/c Ratio	0.46	0.75	0.58	0.32	0.10

Intersection Summary

~ Volume exceeds capacity, queue is theoretically infinite.
 Queue shown is maximum after two cycles.

Lanes, Volumes, Timings
4: Dade Blvd & N Michigan Ave

5/13/2015

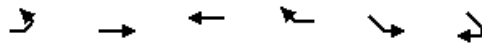

Lane Group	EBL	EBT	WBT	WBR	SEL	SER	ø3
Lane Configurations		↑↑	↑↑	↑	↘↘	↗	
Volume (vph)	0	420	785	832	830	256	
Ideal Flow (vphpl)	1900	1900	1900	1900	1900	1900	
Lane Width (ft)	10	10	10	10	10	10	
Storage Length (ft)	0			280	0	0	
Storage Lanes	0			1	2	1	
Taper Length (ft)	25				25		
Lane Util. Factor	1.00	0.95	0.95	1.00	0.97	1.00	
Ped Bike Factor							
Frt				0.850		0.850	
Flt Protected					0.950		
Satd. Flow (prot)	0	3271	3303	1478	3236	1492	
Flt Permitted					0.950		
Satd. Flow (perm)	0	3271	3303	1478	3236	1492	
Right Turn on Red				No		Yes	
Satd. Flow (RTOR)						275	
Link Speed (mph)		30	30		30		
Link Distance (ft)		246	421		91		
Travel Time (s)		5.6	9.6		2.1		
Confl. Peds. (#/hr)				36			
Peak Hour Factor	0.94	0.94	0.98	0.98	0.93	0.93	
Heavy Vehicles (%)	3%	3%	2%	2%	1%	1%	
Adj. Flow (vph)	0	447	801	849	892	275	
Shared Lane Traffic (%)							
Lane Group Flow (vph)	0	447	801	849	892	275	
Enter Blocked Intersection	No	No	No	No	No	No	
Lane Alignment	Left	Left	Left	Right	Left	Right	
Median Width(ft)		0	0		20		
Link Offset(ft)		0	0		0		
Crosswalk Width(ft)		0	0		10		
Two way Left Turn Lane							
Headway Factor	1.09	1.09	1.09	1.09	1.09	1.09	
Turning Speed (mph)	15			9	15	9	
Number of Detectors		0	0	1	1	1	
Detector Template				Right	Left	Right	
Leading Detector (ft)		0	0	24	24	24	
Trailing Detector (ft)		0	0	-6	-6	-6	
Detector 1 Position(ft)		0	0	-6	-6	-6	
Detector 1 Size(ft)		6	5	30	30	30	
Detector 1 Type		Cl+Ex	Cl+Ex	Cl+Ex	Cl+Ex	Cl+Ex	
Detector 1 Channel							
Detector 1 Extend (s)		0.0	0.0	0.0	0.0	0.0	
Detector 1 Queue (s)		0.0	0.0	0.0	0.0	0.0	
Detector 1 Delay (s)		0.0	0.0	0.0	0.0	0.0	
Turn Type		NA	NA	pt+ov	NA	Perm	
Protected Phases		6	2	2 4	4		3
Permitted Phases						4	
Detector Phase				2 4	4	4	
Switch Phase							

Lanes, Volumes, Timings
4: Dade Blvd & N Michigan Ave

5/13/2015

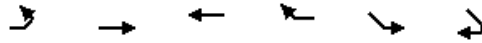

Lane Group	EBL	EBT	WBT	WBR	SEL	SER	ø3
Minimum Initial (s)		14.0	14.0		7.0	7.0	7.0
Minimum Split (s)		34.8	34.8		20.6	20.6	11.0
Total Split (s)		45.8	45.8		54.2	54.2	30.0
Total Split (%)		35.2%	35.2%		41.7%	41.7%	23%
Maximum Green (s)		41.0	41.0		49.6	49.6	26.0
Yellow Time (s)		4.0	4.0		4.0	4.0	3.5
All-Red Time (s)		0.8	0.8		0.6	0.6	0.5
Lost Time Adjust (s)		2.5	2.5		2.5	2.5	
Total Lost Time (s)		7.3	7.3		7.1	7.1	
Lead/Lag					Lag	Lag	Lead
Lead-Lag Optimize?					Yes	Yes	Yes
Vehicle Extension (s)		1.0	1.0		2.5	2.5	3.0
Recall Mode		Min	Min		None	None	None
Walk Time (s)		7.0	7.0				
Flash Dont Walk (s)		23.0	23.0				
Pedestrian Calls (#/hr)		36	10				
Act Effect Green (s)		20.7	20.7	61.6	25.0	25.0	
Actuated g/C Ratio		0.34	0.34	1.00	0.41	0.41	
v/c Ratio		0.41	0.72	0.57	0.68	0.36	
Control Delay		18.4	23.6	1.6	17.8	3.1	
Queue Delay		0.0	0.0	0.0	0.0	0.0	
Total Delay		18.4	23.6	1.6	17.8	3.1	
LOS		B	C	A	B	A	
Approach Delay		18.5	12.3		14.3		
Approach LOS		B	B		B		

Intersection Summary

Area Type: Other
 Cycle Length: 130
 Actuated Cycle Length: 61.6
 Natural Cycle: 75
 Control Type: Semi Act-Uncoord
 Maximum v/c Ratio: 0.72
 Intersection Signal Delay: 13.9
 Intersection Capacity Utilization 60.7%
 Analysis Period (min) 15

Intersection LOS: B
 ICU Level of Service B

Splits and Phases: 4: Dade Blvd & N Michigan Ave

← ø2	↔ ø3	↘ ø4
45.8 s	30 s	54.2 s
→ ø6		
45.8 s		

Queues

4: Dade Blvd & N Michigan Ave

5/13/2015



Lane Group	EBT	WBT	WBR	SEL	SER
Lane Group Flow (vph)	447	801	849	892	275
v/c Ratio	0.41	0.72	0.57	0.68	0.36
Control Delay	18.4	23.6	1.6	17.8	3.1
Queue Delay	0.0	0.0	0.0	0.0	0.0
Total Delay	18.4	23.6	1.6	17.8	3.1
Queue Length 50th (ft)	62	127	0	158	0
Queue Length 95th (ft)	149	285	0	209	35
Internal Link Dist (ft)	166	341		11	
Turn Bay Length (ft)			280		
Base Capacity (vph)	1097	1107	1478	2521	1223
Starvation Cap Reductn	0	0	0	0	0
Spillback Cap Reductn	0	0	0	0	0
Storage Cap Reductn	0	0	0	0	0
Reduced v/c Ratio	0.41	0.72	0.57	0.35	0.22

Intersection Summary